

Machine Automation Controller

NJ-series

## Robot Integrated System

### Startup Guide

NJ501-R□□□

AC1-152000

RL4-□□□□□□□

RX4-□□□□□□□

## NOTE

1. All rights reserved. No part of this publication may be reproduced, stored in a retrieval system, or transmitted, in any form, or by any means, mechanical, electronic, photocopying, recording, or otherwise, without the prior written permission of OMRON.
2. No patent liability is assumed with respect to the use of the information contained herein. Moreover, because OMRON is constantly striving to improve its high-quality products, the information contained in this manual is subject to change without notice.
3. Every precaution has been taken in the preparation of this manual. Nevertheless, OMRON assumes no responsibility for errors or omissions. Neither is any liability assumed for damages resulting from the use of the information contained in this publication.

## Trademarks

- Sysmac and SYSMAC are trademarks or registered trademarks of OMRON Corporation in Japan and other countries for OMRON factory automation products.
- Microsoft, Windows, Excel, Visual Basic, and Microsoft Edge are either registered trademarks or trademarks of Microsoft Corporation in the United States and other countries.
- EtherCAT® is registered trademark and patented technology, licensed by Beckhoff Automation GmbH, Germany.
- ODVA, CIP, CompoNet, DeviceNet, and EtherNet/IP are trademarks of ODVA.
- The SD and SDHC logos are trademarks of SD-3C, LLC. 

Other company names and product names in this document are the trademarks or registered trademarks of their respective companies.

## Copyrights

- Microsoft product screen shots used with permission from Microsoft.
- The CAD data in inCAD Library is used with permission from MISUMI Corporation. Copyright of any of information in CAD data belongs to MISUMI Corporation or its respective manufacturer. MISUMI Corporation may not offer all parts in each application design. Available parts can only be purchased separately not as a unit shown in each application design. MISUMI Corporation does not guarantee quality, accuracy, functionality, safety or reliability for the combination of the parts in each application example.
- This product incorporates certain third party software. The license and copyright information associated with this software is available at [http://www.fa.omron.co.jp/nj\\_info\\_e/](http://www.fa.omron.co.jp/nj_info_e/).

# Introduction

Thank you for purchasing an NJ-series Robot Integrated CPU Unit.

This guide describes the startup procedure of the "Robot Integrated System" that contains NJ-series Robot Integrated CPU Unit and Omron robots and the basic operating procedure of the Sysmac Studio using a simple machine model. You can learn the basics of the Robot Integrated System in a short time while you operate the system according to this guide.

For information on wiring and operation settings of NJ-series Robot Integrated CPU Unit, IPC Application Controller, robots and their peripheral devices, refer to *Related Manuals* on page 22.

This guide does not contain safety information and other details required for actual use of the products. Thoroughly read and understand the manuals for all of the devices that are used in this guide to ensure that the system is used safely. Review the entire contents of these materials, including all safety precautions, precautions for safe use, and precautions for correct use.

For safety instruction of the robot and details on robot use, refer to the *Robot Safety Guide (Cat. No. I590)*.

## Intended Audience

This manual is intended for the following personnel, who must also have knowledge of electrical systems (an electrical engineer or the equivalent).

- Personnel in charge of introducing FA systems.
- Personnel in charge of designing FA systems.
- Personnel in charge of installing and maintaining FA systems.
- Personnel in charge of managing FA systems and facilities.

Also, this manual is intended for the personnel, who understand the following contents.

- Personnel who understand the programming language specifications in international standard IEC 61131-3 or Japanese standard JIS B 3503, for programming\*1.
- Personnel who understand the specifications of NJ-series CPU Unit and know how to use it\*1.
- Personnel who understand basic operation procedure of the Sysmac Studio\*1.
- Personnel who have attended the industrial robot seminar held by Omron or have equivalent knowledge.
- Personnel in charge of working with a robot and well knowing how to handle the robot.

\*1. For information of the international standard IEC 61131-3 and basic operation procedure of NJ-series CPU Unit and Sysmac Studio, refer to the *Relevant Technical Guides* on page 25.

## Applicable Products

This manual covers the following products.

- NJ-series Robot Integrated CPU Unit  
NJ501-R□□□
- SCARA robot eCobra 600/800  
RL4-□□□□□□□□
- IPC Application Controller

AC1-152000

# Relevant Manuals

The following table provides the relevant manuals for the NJ-series CPU Units. Read all of the manuals that are relevant to your system configuration and application before you use the NJ-series CPU Unit.

Most operations are performed from the Sysmac Studio Automation Software. Refer to the *Sysmac Studio Version 1 Operation Manual (Cat. No. W504)* and the *Sysmac Studio Robot Integrated System Building Function with Robot Integrated CPU Unit Operation Manual (Cat. No. W595)* for information on the Sysmac Studio.

Purpose of use	Manual											
	Basic information		NJ/NX-series Troubleshooting Manual	NJ-series NJ Robotics CPU Unit User's Manual	eY+3 Keyword Reference Manual	eY+3 User's Manual	NJ-series Robot Integrated CPU Unit User's Manual	NJ/NX-series Database Connection CPU Units User's Manual	NJ/NX-series CPU Unit Built-in EtherNet/IP Port User's Manual	NJ/NX-series CPU Unit Built-in EtherCAT Port User's Manual	NJ/NX-series Motion Control Instructions Reference Manual	
	NJ-series CPU Unit Hardware User's Manual	NJ/NX-series CPU Unit Software User's Manual										
Introduction to NJ-series Controllers	○											
Setting devices and hardware	○											
Using motion control			○									
Using EtherCAT							○					
Using EtherNet/IP							○					
Using robot control for OMRON robots						○						
Software settings	○											
Using motion control			○									
Using EtherCAT							○					
Using EtherNet/IP							○					
Using database connection service							○					
Using robot control for OMRON robots							○	○	○			
Using robot control with NJ Robotics function									○			
Writing the user program	○	○										
Using motion control				○	○							
Using EtherCAT								○				
Using EtherNet/IP								○				
Using database connection service								○				
Using robot control for OMRON robots								○	○	○		
Using robot control with NJ Robotics function											○	
Programming error processing						○	○	○		○		

Purpose of use	Manual												
	Basic information		NJ/NX-series Instructions Reference Manual	NJ/NX-series CPU Unit Motion Control User's Manual	NJ/NX-series Motion Control Instructions Reference Manual	NJ/NX-series CPU Unit Built-in EtherCAT Port User's Manual	NJ/NX-series CPU Unit Built-in EtherNet/IP Port User's Manual	NJ/NX-series Database Connection CPU Units User's Manual	NJ-series Robot Integrated CPU Unit User's Manual	eV+3 User's Manual	eV+3 Keyword Reference Manual	NJ-series NJ Robotics CPU Unit User's Manual	NJ/NX-series Troubleshooting Manual
	NJ-series CPU Unit Hardware User's Manual	NJ/NX-series CPU Unit Software User's Manual											
Testing operation and debugging													
Using motion control				○									
Using EtherCAT						○							
Using EtherNet/IP		○				○							
Using database connection service							○						
Using robot control for OMRON robots								○	○	○			
Using robot control with NJ Robotics function											○		
Learning about error management functions and corrections*1								△	△	△	△	△	○
Maintenance													
Using motion control	○			○									
Using EtherCAT						○							
Using EtherNet/IP						○							

\*1. Refer to the *NJ/NX-series Troubleshooting Manual (Cat. No. W503)* for the error management concepts and the error items. However, refer to the manuals that are indicated with triangles for details on errors corresponding to the products with the manuals that are indicated with triangles.

# Manual Structure

## Page Structure

The following page structure is used in this manual.

The diagram illustrates the structure of a manual page, showing various elements and their corresponding labels:

- Level 1 heading:** 4 Installation and Wiring
- Level 2 heading:** 4-3 Mounting Units
- Level 3 heading:** 4-3-1 Connecting Controller Components
- Page tab:** 4
- Special information:** Precautions for Correct Use
- Manual name:** NJ-series CPU Unit Hardware User's Manual (W500)

Annotations also describe the content of the page:

- Level 2 heading:** 4-3 Mounting Units
- Level 3 heading:** 4-3-1 Connecting Controller Components
- A step in a procedure:** 1 Join the Units so that the connectors fit exactly.
- Indicates a procedure:** 2 The yellow sliders at the top and bottom of each Unit lock the Units together. Move the sliders toward the back of the Units as shown below until they click into place.

Additional annotations include:

- Level 3 heading:** Gives the current headings.
- Page tab:** Gives the number of the main section.
- Special information:** Icons indicate precautions, additional information, or reference information.

This illustration is provided only as a sample. It may not literally appear in this manual.

## Special Information

Special information in this manual is classified as follows:



### Precautions for Safe Use

Precautions on what to do and what not to do to ensure safe usage of the product.



### Precautions for Correct Use

Precautions on what to do and what not to do to ensure proper operation and performance.



### Additional Information

Additional information to read as required.

This information is provided to increase understanding or make operation easier.



### Version Information

Information on differences in specifications and functionality for Controller with different unit versions and for different versions of the Sysmac Studio is given.

## Precaution on Terminology

In this manual, "download" refers to transferring data from the Sysmac Studio to the physical Controller and "upload" refers to transferring data from the physical Controller to the Sysmac Studio. For the Sysmac Studio, "synchronization" is used to both "upload" and "download" data. Here, "synchronize" means to automatically compare the data for the Sysmac Studio on the computer with the data in the physical Controller and transfer the data in the direction that is specified by the user.



# Sections in this Manual

---

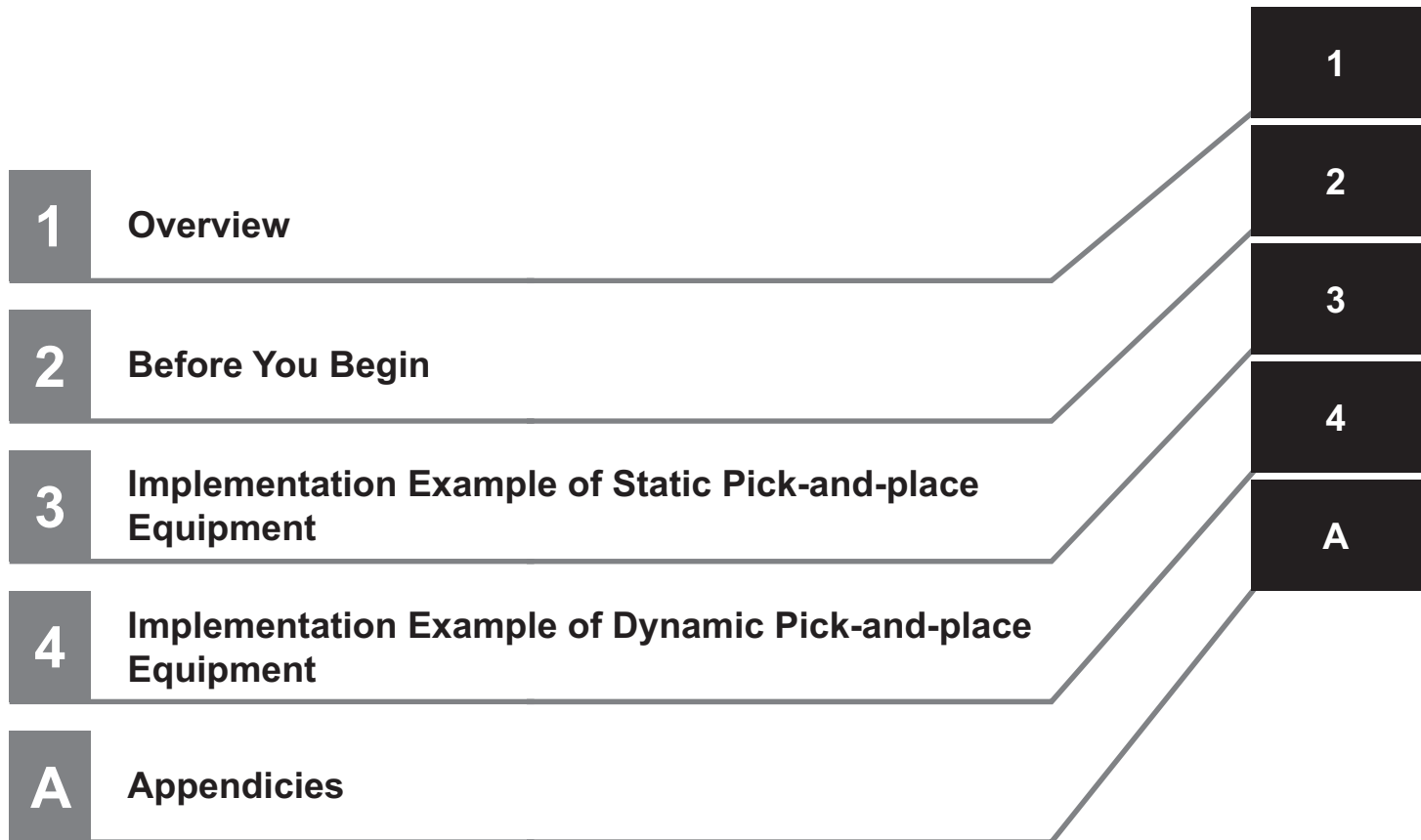

# CONTENTS

---

<b>Introduction .....</b>	<b>1</b>
Intended Audience .....	1
Applicable Products .....	1
<b>Relevant Manuals.....</b>	<b>3</b>
<b>Manual Structure.....</b>	<b>5</b>
Page Structure.....	5
Special Information .....	6
Precaution on Terminology .....	6
<b>Sections in this Manual .....</b>	<b>7</b>
<b>Terms and Conditions Agreement.....</b>	<b>11</b>
Warranty, Limitations of Liability .....	11
Application Considerations .....	12
Disclaimers .....	12
<b>Safety Precautions.....</b>	<b>14</b>
Definition of Precautionary Information.....	14
Symbols .....	14
WARNING.....	15
Cautions.....	15
<b>Precautions for Safe Use .....</b>	<b>16</b>
<b>Precautions for Correct Use .....</b>	<b>17</b>
<b>Regulations and Standards .....</b>	<b>18</b>
<b>Versions .....</b>	<b>19</b>
Checking Versions .....	19
<b>Related Manuals.....</b>	<b>22</b>
<b>Relevant Technical Guides.....</b>	<b>25</b>
<b>Terminology.....</b>	<b>26</b>
<b>Revision History.....</b>	<b>27</b>

## Section 1 Overview

---

<b>1-1 Features of Robot Integrated System.....</b>	<b>1-2</b>
1-1-1 Features of the NJ-series Robot Integrated CPU Unit .....	1-2
1-1-2 Features of the EtherCAT-compatible OMRON robots .....	1-2
1-1-3 Features of the Sysmac Studio Automation Software.....	1-2
<b>1-2 System configuration to build in this guide.....</b>	<b>1-3</b>
<b>1-3 System Configuration for Static Pick-and-place Equipment.....</b>	<b>1-4</b>
<b>1-4 Operations of Static Pick-and-place Equipment.....</b>	<b>1-6</b>
1-4-1 Operating Specifications .....	1-6

1-4-2	Operating Modes for Equipment .....	1-7
<b>1-5</b>	<b>System Configuration for Dynamic Pick-and-place Equipment.....</b>	<b>1-8</b>
<b>1-6</b>	<b>Operations of Dynamic Pick-and-place Equipment.....</b>	<b>1-10</b>
1-6-1	Operating Specifications .....	1-10
1-6-2	Operating Modes for Equipment .....	1-11
<b>1-7</b>	<b>Hardware.....</b>	<b>1-12</b>
<b>1-8</b>	<b>Software.....</b>	<b>1-14</b>
1-8-1	Sysmac Studio .....	1-14
1-8-2	Application Manager .....	1-14
<b>1-9</b>	<b>User Program .....</b>	<b>1-16</b>
1-9-1	Types of Method to Create User Program .....	1-16
1-9-2	Proper Use of Sequence Control Program and V+ Program .....	1-16
1-9-3	Command and Data Flow .....	1-17

## Section 2 Before You Begin

<b>2-1</b>	<b>Installing the Sysmac Studio .....</b>	<b>2-2</b>
------------	---	------------

## Section 3 Implementation Example of Static Pick-and-place Equipment

<b>3-1</b>	<b>Program Specifications for Static Pick-and-place Equipment .....</b>	<b>3-2</b>
3-1-1	When Operations are Controlled with Sequence Control Program.....	3-3
3-1-2	When Operations are Controlled with V+ Program .....	3-10
<b>3-2</b>	<b>Basic Startup Procedures .....</b>	<b>3-17</b>
<b>3-3</b>	<b>Programming and Simulation Procedures .....</b>	<b>3-19</b>
3-3-1	Creating a Project File.....	3-19
3-3-2	Creating the EtherCAT Network Configuration.....	3-20
3-3-3	Creating a Sequence Control Program .....	3-22
3-3-4	Creating V+ Programs.....	3-28
3-3-5	Placing 3D Shape Data .....	3-35
3-3-6	Starting Simulation .....	3-65
3-3-7	Teaching Positions .....	3-66
3-3-8	Setting up Automatic Loading of V+ Programs and Variables at Power ON.....	3-77
3-3-9	Running the Program and Checking Operation .....	3-81
<b>3-4</b>	<b>Installing and Wiring the System .....</b>	<b>3-86</b>
3-4-1	Wiring the Robot Integrated CPU Unit and the EtherCAT Digital I/O Terminal .....	3-86
3-4-2	Setting the Node Address of the EtherCAT Digital I/O Terminal .....	3-87
3-4-3	Wiring the EtherCAT Digital I/O Terminal and the Robot.....	3-87
3-4-4	Setting the EtherCAT Node Address of the Robot .....	3-88
3-4-5	Wiring the Robot Integrated CPU Unit and the Computer .....	3-88
3-4-6	Wiring the Robot, T20 Pendant and the Front Panel .....	3-89
3-4-7	Wiring the EtherCAT Digital I/O Terminal and Solenoid Valve .....	3-90
<b>3-5</b>	<b>Setup Procedure for Actual System.....</b>	<b>3-92</b>
3-5-1	Connecting Online.....	3-92
3-5-2	Transferring Settings and Programs .....	3-94
3-5-3	Teaching.....	3-96
3-5-4	Executing Program to Check Operation.....	3-108

## Section 4 Implementation Example of Dynamic Pick-and-place Equipment

<b>4-1</b>	<b>Program Specifications for Dynamic Pick-and-place Equipment .....</b>	<b>4-3</b>
------------	--	------------

4-1-1	Program Structure.....	4-3
<b>4-2</b>	<b>Basic Startup Procedures .....</b>	<b>4-12</b>
<b>4-3</b>	<b>Programming and Simulation Procedures .....</b>	<b>4-15</b>
4-3-1	Creating a Project File.....	4-15
4-3-2	Creating the EtherCAT Network Configuration.....	4-16
4-3-3	Creating V+ Programs.....	4-19
4-3-4	Writing a Sequence Control Program.....	4-23
4-3-5	Placing 3D Shape Data.....	4-30
4-3-6	Creating a Pack Manager Sample .....	4-53
4-3-7	Creating C# Programs .....	4-81
4-3-8	Setting up Automatic Loading of V+ Programs and Variables at Power ON.....	4-83
4-3-9	Executing Program to Check Operation.....	4-87
<b>4-4</b>	<b>Installing and Wiring the System .....</b>	<b>4-93</b>
4-4-1	Wiring the Robot Integrated CPU Unit and the EtherCAT Digital I/O Terminal .....	4-94
4-4-2	Setting the Node Address of the EtherCAT Digital I/O Terminal .....	4-94
4-4-3	Wiring the EtherCAT Digital I/O Terminal and Inverter's EtherCAT Communications Unit.....	4-95
4-4-4	Setting the Node Address of Inverter's EtherCAT Communications Unit.....	4-95
4-4-5	Wiring the Inverter's EtherCAT Communications Unit and Robot.....	4-95
4-4-6	Setting the EtherCAT Node Address of the Robot .....	4-96
4-4-7	Wiring the Robot, T20 Pendant and the Front Panel .....	4-96
4-4-8	Wiring the Robot and Encoder .....	4-98
4-4-9	Wiring the EtherNet/IP Port on the Robot Integrated CPU Unit.....	4-99
4-4-10	Wiring Between the IPC Application Controller, Display, and Camera.....	4-100
4-4-11	Wiring the Camera and Robot.....	4-100
4-4-12	Wiring the EtherCAT Digital I/O Terminal and Solenoid Valve .....	4-101
<b>4-5</b>	<b>Operation Check on the Actual System.....</b>	<b>4-103</b>
4-5-1	Communications Setup .....	4-103
4-5-2	Online Connection.....	4-110
4-5-3	Transferring Settings and Programs .....	4-111
4-5-4	Setting up the Camera .....	4-115
4-5-5	Running a Sequence Control Program and V+ Program .....	4-126
4-5-6	Turning Robot High Power ON .....	4-128
4-5-7	Calibrating the Belt.....	4-130
4-5-8	Calibrating the Sensor.....	4-135
4-5-9	Setting the Locator .....	4-146
4-5-10	Teaching Idle, Pick, and Place Positions.....	4-151
4-5-11	Running the Program to Check the Operation .....	4-154

## Appendices

<b>A-1</b>	<b>Designing Example of the Safety Functions for the Pick-and-place Equipment.....</b>	<b>A-2</b>
A-1-1	Pick-and-place Equipment Configuration .....	A-2
A-1-2	Hazards .....	A-4
A-1-3	Protective Measure .....	A-4
A-1-4	Safety Functions .....	A-4
A-1-5	Safety System Configuration and Devices .....	A-5
A-1-6	Installation and Wiring.....	A-7
A-1-7	Settings and Programming.....	A-13
<b>A-2</b>	<b>How to Use 3D Visualizer .....</b>	<b>A-21</b>
A-2-1	Set the 3D Visualizer to the Float Mode.....	A-21
A-2-2	Rotate the Viewpoint .....	A-23
A-2-3	Translate the Viewpoint.....	A-25
A-2-4	Zoom-in and Zoom-out.....	A-26
<b>A-3</b>	<b>Setting Items on the Sysmac Studio and the Setting Targets .....</b>	<b>A-28</b>
<b>A-4</b>	<b>Using Troubleshooting Functions.....</b>	<b>A-29</b>

# Terms and Conditions Agreement

---

## Warranty, Limitations of Liability

### Warranties

---

- **Exclusive Warranty**

Omron's exclusive warranty is that the Products will be free from defects in materials and workmanship for a period of twelve months from the date of sale by Omron (or such other period expressed in writing by Omron). Omron disclaims all other warranties, express or implied.

- **Limitations**

OMRON MAKES NO WARRANTY OR REPRESENTATION, EXPRESS OR IMPLIED, ABOUT NON-INFRINGEMENT, MERCHANTABILITY OR FITNESS FOR A PARTICULAR PURPOSE OF THE PRODUCTS. BUYER ACKNOWLEDGES THAT IT ALONE HAS DETERMINED THAT THE PRODUCTS WILL SUITABLY MEET THE REQUIREMENTS OF THEIR INTENDED USE.

Omron further disclaims all warranties and responsibility of any type for claims or expenses based on infringement by the Products or otherwise of any intellectual property right.

- **Buyer Remedy**

Omron's sole obligation hereunder shall be, at Omron's election, to (i) replace (in the form originally shipped with Buyer responsible for labor charges for removal or replacement thereof) the non-complying Product, (ii) repair the non-complying Product, or (iii) repay or credit Buyer an amount equal to the purchase price of the non-complying Product; provided that in no event shall Omron be responsible for warranty, repair, indemnity or any other claims or expenses regarding the Products unless Omron's analysis confirms that the Products were properly handled, stored, installed and maintained and not subject to contamination, abuse, misuse or inappropriate modification. Return of any Products by Buyer must be approved in writing by Omron before shipment. Omron Companies shall not be liable for the suitability or unsuitability or the results from the use of Products in combination with any electrical or electronic components, circuits, system assemblies or any other materials or substances or environments. Any advice, recommendations or information given orally or in writing, are not to be construed as an amendment or addition to the above warranty.

See <http://www.omron.com/global/> or contact your Omron representative for published information.

### Limitation on Liability; Etc

---

OMRON COMPANIES SHALL NOT BE LIABLE FOR SPECIAL, INDIRECT, INCIDENTAL, OR CONSEQUENTIAL DAMAGES, LOSS OF PROFITS OR PRODUCTION OR COMMERCIAL LOSS IN ANY

WAY CONNECTED WITH THE PRODUCTS, WHETHER SUCH CLAIM IS BASED IN CONTRACT, WARRANTY, NEGLIGENCE OR STRICT LIABILITY.

Further, in no event shall liability of Omron Companies exceed the individual price of the Product on which liability is asserted.

## Application Considerations

### Suitability of Use

Omron Companies shall not be responsible for conformity with any standards, codes or regulations which apply to the combination of the Product in the Buyer's application or use of the Product. At Buyer's request, Omron will provide applicable third party certification documents identifying ratings and limitations of use which apply to the Product. This information by itself is not sufficient for a complete determination of the suitability of the Product in combination with the end product, machine, system, or other application or use. Buyer shall be solely responsible for determining appropriateness of the particular Product with respect to Buyer's application, product or system. Buyer shall take application responsibility in all cases.

NEVER USE THE PRODUCT FOR AN APPLICATION INVOLVING SERIOUS RISK TO LIFE OR PROPERTY OR IN LARGE QUANTITIES WITHOUT ENSURING THAT THE SYSTEM AS A WHOLE HAS BEEN DESIGNED TO ADDRESS THE RISKS, AND THAT THE OMRON PRODUCT(S) IS PROPERLY RATED AND INSTALLED FOR THE INTENDED USE WITHIN THE OVERALL EQUIPMENT OR SYSTEM.

### Programmable Products

Omron Companies shall not be responsible for the user's programming of a programmable Product, or any consequence thereof.

## Disclaimers

### Performance Data

Data presented in Omron Company websites, catalogs and other materials is provided as a guide for the user in determining suitability and does not constitute a warranty. It may represent the result of Omron's test conditions, and the user must correlate it to actual application requirements. Actual performance is subject to the Omron's Warranty and Limitations of Liability.

### Change in Specifications

Product specifications and accessories may be changed at any time based on improvements and other reasons. It is our practice to change part numbers when published ratings or features are changed, or when significant construction changes are made. However, some specifications of the Product may

be changed without any notice. When in doubt, special part numbers may be assigned to fix or establish key specifications for your application. Please consult with your Omron's representative at any time to confirm actual specifications of purchased Product.

## **Errors and Omissions**

---

Information presented by Omron Companies has been checked and is believed to be accurate; however, no responsibility is assumed for clerical, typographical or proofreading errors or omissions.



# Safety Precautions

## Definition of Precautionary Information





The following notation is used in this manual to provide precautions required to ensure safe usage of the NJ-series Robot Integrated CPU Unit.

The safety precautions that are provided are extremely important for safety. Always read and heed the information provided in all safety precautions.

The following notation is used.

 <b>WARNING</b>	Indicates a potentially hazardous situation which, if not avoided, could result in death or serious injury. Additionally, there may be severe property damage.
 <b>Caution</b>	Indicates a potentially hazardous situation which, if not avoided, may result in minor or moderate injury, or property damage.

## Symbols

	The circle and slash symbol indicates operations that you must not do. The specific operation is shown in the circle and explained in text. This example indicates that disassembly is prohibited.
	The triangle symbol indicates precautions (including warnings). The specific operation is shown in the triangle and explained in text. This example indicates a precaution for electric shock.
	The triangle symbol indicates precautions (including warnings). The specific operation is shown in the triangle and explained in text. This example indicates a general precaution.
	The filled circle symbol indicates operations that you must do. The specific operation is shown in the circle and explained in text. This example shows a general precaution for something that you must do.



**WARNING** **WARNING**

Refer to the following manuals for warnings.

- *NJ-series CPU Unit Hardware User's Manual (Cat. No. W500)*
- *NJ-series Robot Integrated CPU Unit User's Manual (Cat. No. O037)*

**Cautions** **Caution**

Refer to the following manuals for cautions.

- *NJ-series CPU Unit Hardware User's Manual (Cat. No. W500)*
- *NJ-series Robot Integrated CPU Unit User's Manual (Cat. No. O037)*

# Precautions for Safe Use

---

Refer to the following manuals for precautions for safe use.

- *NJ-series CPU Unit Hardware User's Manual (Cat. No. W500)*
- *NJ-series Robot Integrated CPU Unit User's Manual (Cat. No. O037)*

# Precautions for Correct Use

---

Refer to the following manuals for precautions for correct use.

- *NJ-series CPU Unit Hardware User's Manual (Cat. No. W500)*
- *NJ-series Robot Integrated CPU Unit User's Manual (Cat. No. O037)*

# Regulations and Standards

---

Refer to the following manuals for regulations and standards.

- *NJ-series CPU Unit Hardware User's Manual (Cat. No. W500)*



## **Additional Information**

---

The Robot Integrated CPU Unit is not a robot control device that is defined in ISO 10218-1. Therefore, the Robot Integrated CPU Unit does not comply with the robot regulations and standards.

Refer to the OMRON robot manuals for information on the OMRON robot itself.

---

# Versions

Hardware revisions and unit versions are used to manage the hardware and software in NJ-series Units and EtherCAT slaves. The hardware revision or unit version is updated each time there is a change in hardware or software specifications. Even when two Units or EtherCAT slaves have the same model number, they will have functional or performance differences if they have different hardware revisions or unit versions.

## Checking Versions

You can check versions on the ID information indications or with the Sysmac Studio.

### Checking Unit Versions on ID Information Indications

The unit version is given on the ID information indication on the side of the product.

- **NJ501-R□□00**

The ID information on the NJ-series NJ501-R300 CPU Unit is shown below.

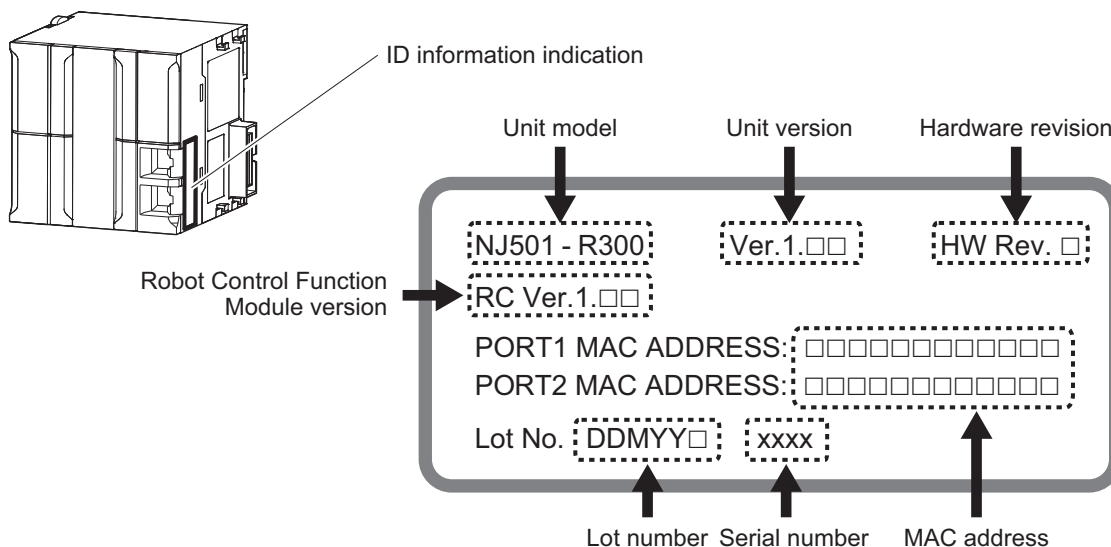

**Note** The hardware revision is not displayed for the Unit that the hardware revision is in blank.

## Checking Unit Versions with the Sysmac Studio

You can use the Sysmac Studio to check unit versions.

### ● Checking the Unit Version of an NJ-series CPU Unit

You can use the Production Information while the Sysmac Studio is online to check the unit version of a Unit. You can do this for the CPU Unit, CJ-series Special I/O Units, and CJ-series CPU Bus Units. You cannot check the unit versions of CJ-series Basic I/O Units with the Sysmac Studio.

- 1 Double-click **CPU Rack** under **Configurations and Setup - CPU/Expansion Racks** in the Multiview Explorer. Or, right-click **CPU Rack** under **Configurations and Setup - CPU/Expansion Racks** in the Multiview Explorer and select **Edit** from the menu.  
The Unit Editor is displayed.
- 2 Right-click any open space in the Unit Editor and select **Production Information**.  
The Production Information Dialog Box is displayed.

### ● Changing Information Displayed in Production Information Dialog Box

- 1 Click the **Show Detail** or **Show Outline** Button at the lower right of the **Production Information** Dialog Box.  
The view will change between the **production information** details and outline.

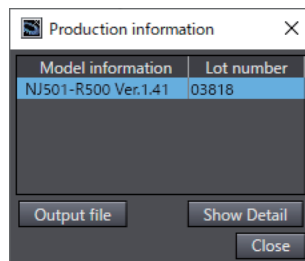

Outline View

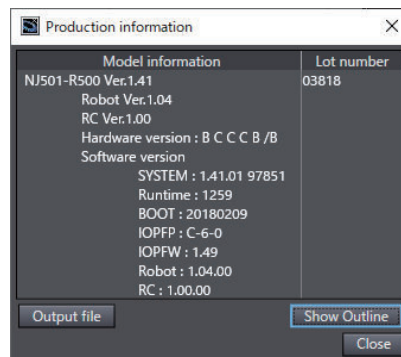

Detailed View

The information that is displayed is different for the Outline View and Detail View. The Detail View displays the unit version, hardware revision, and various versions. The Outline View displays only the unit version.

**Note** The hardware revision is separated by “/” and displayed on the right of the hardware version. The hardware revision is not displayed for the Unit that the hardware revision is in blank.

### ● Changing Information Displayed in Production Information Dialog Box

- 1 Click the **Show Detail** or **Show Outline** Button at the lower right of the **Production Information** Dialog Box.  
The view will change between the **production information** details and outline.

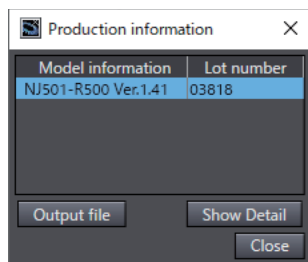

Outline View

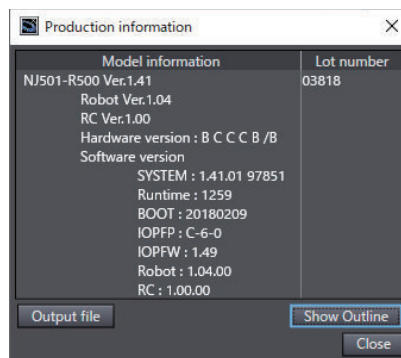

Detailed View

# Related Manuals

The following are the manuals related to this manual. Use these manuals for reference.

Manual name	Cat. No.	Model numbers	Application	Description
NJ-series CPU Unit Hardware User's Manual	W500	NJ501-□□□□ NJ301-□□□□ NJ101-□□□□	Learning the basic specifications of the NJ-series CPU Units, including introductory information, designing, installation, and maintenance. Mainly hardware information is provided.	An introduction to the entire NJ-series system is provided along with the following information on the CPU Unit. <ul style="list-style-type: none"> <li>• Features and system configuration</li> <li>• Introduction</li> <li>• Part names and functions</li> <li>• General specifications</li> <li>• Installation and wiring</li> <li>• Maintenance and inspection</li> </ul>
NJ/NX-series CPU Unit Software User's Manual	W501	NX701-□□□□ NX102-□□□□ NX1P2-□□□□ NJ501-□□□□ NJ301-□□□□ NJ101-□□□□	Learning how to program and set up an NJ/NX-series CPU Unit. Mainly software information is provided.	The following information is provided on a Controller built with an NJ/NX-series CPU Unit. <ul style="list-style-type: none"> <li>• CPU Unit operation</li> <li>• CPU Unit features</li> <li>• Initial settings</li> <li>• Programming based on IEC 61131-3 language specifications</li> </ul>
NJ/NX-series Instructions Reference Manual	W502	NX701-□□□□ NX102-□□□□ NX1P2-□□□□ NJ501-□□□□ NJ301-□□□□ NJ101-□□□□	Learning detailed specifications on the basic instructions of an NJ/NX-series CPU Unit.	The instructions in the instruction set (IEC 61131-3 specifications) are described.
NJ/NX-series CPU Unit Motion Control User's Manual	W507	NX701-□□□□ NX102-□□□□ NX1P2-□□□□ NJ501-□□□□ NJ301-□□□□ NJ101-□□□□	Learning about motion control settings and programming concepts.	The settings and operation of the CPU Unit and programming concepts for motion control are described.
NJ/NX-series Motion Control Instructions Reference Manual	W508	NX701-□□□□ NX102-□□□□ NX1P2-□□□□ NJ501-□□□□ NJ301-□□□□ NJ101-□□□□	Learning about the specifications of the motion control instructions.	The motion control instructions are described.
NJ/NX-series CPU Unit Built-in EtherCAT® Port User's Manual	W505	NX701-□□□□ NX102-□□□□ NX1P2-□□□□ NJ501-□□□□ NJ301-□□□□ NJ101-□□□□	Using the built-in EtherCAT port on an NJ/NX-series CPU Unit.	Information on the built-in EtherCAT port is provided. This manual provides an introduction and provides information on the configuration, features, and setup.
NJ/NX-series CPU Unit Built-in EtherNet/IP™ Port User's Manual	W506	NX701-□□□□ NX102-□□□□ NX1P2-□□□□ NJ501-□□□□ NJ301-□□□□ NJ101-□□□□	Using the built-in EtherNet/IP port on an NJ/NX-series CPU Unit.	Information on the built-in EtherNet/IP port is provided. Information is provided on the basic setup, tag data links, and other features.
NJ-series Robot Integrated CPU Unit User's Manual	O037	NJ501-R□□□	Using the NJ-series Robot Integrated CPU Unit.	Describes the settings and operation of the CPU Unit and programming concepts for OMRON robot control.



Manual name	Cat. No.	Model numbers	Application	Description
Sysmac Studio Robot Integrated System Building Function with Robot Integrated CPU Unit Operation Manual	W595	SYSMAC-SE2□□□ SYSMAC-SE200D-64	Learning about the operating procedures and functions of the Sysmac Studio to configure Robot Integrated System using Robot Integrated CPU Unit.	Describes the operating procedures of the Sysmac Studio for Robot Integrated CPU Unit.
Sysmac Studio Robot Integrated System Building Function with IPC Application Controller Operation Manual	W621	SYSMAC-SE2□□□ SYSMAC-SE200D-64	Learning about the operating procedures and functions of the Sysmac Studio to configure Robot Integrated System using IPC Application Controller.	Describes the operating procedures of the Sysmac Studio for IPC Application Controller.
Sysmac Studio 3D Simulation Function Operation Manual	W618	SYSMAC-SE2□□□ SYSMAC-SA4□□□-64	Learning about an outline of the 3D simulation function of the Sysmac Studio and how to use the function.	Describes an outline, execution procedures, and operating procedures for the 3D simulation function of the Sysmac Studio.
eV+3 User's Manual	I651	NJ501-R□□□	Operating the OMRON robot with the V+ program.	Describes the V+ language to control the OMRON robots.
eV+3 Keyword Reference Manual	I652	NJ501-R□□□	Operating the OMRON robot with the V+ program.	Describes V+ keywords that are used in the V+ language.
eCobra 600 and 800 Robot with EtherCAT User's Guide	I653	RL4-116□□□□ RL4-216□□□□	Using the eCobra.	Describes the eCobra.
i4L Robots with EtherCAT User's Manual	I659	RS4-2063□□□ RS4-2064□□□ RS4-2065□□□	Using the i4L.	Describes the i4L.
i4H Robots with EtherCAT User's Manual	I661	RS4-2066□□□ RS4-2067□□□ RS4-2068□□□	Using the i4H.	Describes the i4H.
Viper 650 and 850 Robot with EtherCAT User's Guide	I654	RL6-206□□□□	Using the Viper.	Describes the Viper.
iX3 565 Robot with EtherCAT User's Guide	I655	RX3-206□□□□	Using the iX3.	Describes the iX3.
iX4 650 H/HS and 800 H/HS Robot with EtherCAT User's Guide	I656	RX4-216□□□□	Using the iX4.	Describes the iX4.
Robot Safety Guide	I590	RL4-□□□□□□□□ RS4-□□□□□□□□ RL6-□□□□□□□□ RX3-□□□□□□□□ RX4-□□□□□□□□	Learning how to use the OMRON robot safely.	Describes how to use the OMRON robot safely.
Teaching Pendant T20 User's Manual	I601	10046-010	Operating the OMRON robot with a teaching pendant.	Describes the setup, operation, and user maintenance for the Teaching Pendant T20.
IPC Application Controller User's Manual	I632	AC1-152000	Using the IPC Application Controller.	Describes the IPC Application Controller.
NJ/NX-series Database Connection CPU Units User's Manual	W527	NX701-□□20 NX102-□□20 NJ501-□□20 NJ101-□□20	Using the database connection service with NJ/NX-series Controllers.	Describes the database connection service.

Manual name	Cat. No.	Model numbers	Application	Description
NJ-series NJ Robotics CPU Unit User's Manual	W539	NJ501-4□□□ NJ501-R□□□	Controlling robots with NJ-series CPU Units.	Describes the functionality to control robots.
NJ/NX-series Troubleshooting Manual	W503	NX701-□□□□ NX102-□□□□ NX1P2-□□□□ NJ501-□□□□ NJ301-□□□□ NJ101-□□□□	Learning about the errors that may be detected in an NJ/NX-series Con- troller.	Concepts on managing errors that may be detected in an NJ/NX-series Controller and information on individual errors are described.
Sysmac Studio Version 1 Operation Manual	W504	SYSMAC -SE2□□□	Learning about the operating procedures and functions of the Sysmac Studio.	Describes the operating procedures of the Sysmac Studio.
NX-series Position Interface Units User's Manual	W524	NX-EC0□□□ NX-ECS□□□ NX-PG0□□□	Learning how to use NX-series Position Interface Units.	The hardware, setup, and functions for the NX-series Incremental Encoder Input Units, SSI Input Units, and Pulse Output Unit are described.
AC Servomotors/Servo Drives 1S-series with Built-in EtherCAT® Communi- cations User's Manual	I586	R88M-1□ R88D-1SN□-ECT	Learning how to use the Servomotors/ Servo Drives with built-in EtherCAT Communications.	Describes the hardware, setup methods and functions of the Servomotors/Servo Drives with built-in EtherCAT Communi- cations.
	I621	R88M-1AL□/ -1AM□ R88D-1SAN□-ECT		
AC Servomotors/Servo Drives G5 Series with Built-in EtherCAT® Communi- cations User's Manual	I576	R88M-K□ R88D-KN□-ECT	Learning how to use the AC Servomotors/ Servo Drives with built-in EtherCAT Communications.	Describes the hardware, setup methods and functions of the AC Servomotors/ Servo Drives with built-in EtherCAT Com- munications. The Linear Motor Type models and dedi- cated models for position control are avail- able in G5-series.
	I577	R88L-EC-□ R88D-KN□-ECT-L		

# Relevant Technical Guides

The following table lists the relevant technical guides for the NJ-series CPU Units. Use these manuals for reference.

Manual name	Cat. No.	Application	Description
Machine Automation Controller Startup Guide for CPU Unit	W513	Learning about outline and operation procedure of the NJ-series CPU Unit and Sysmac Studio.	Describes the startup procedure of the NJ-series CPU Unit and the basic operating procedure of the Sysmac Studio on an example of simple sequence control.
Machine Automation Controller Startup Guide for Motion Control	W514	Learning about the basics of the motion control functions of the NJ-series CPU Unit.	Describes the startup procedures and Sysmac Studio operating procedures for someone that will use NJ-series motion control functions for the first time. The procedures are explained in simple examples of one-axis positioning and two-axis linear interpolation.

# Terminology

This section describes the terms that are used in this manual.

Term	Description
continuous-path motion	A motion to move continuous operations smoothly without stopping motion of the OMRON robot.
IEC 61131-3 language	A programming language to write a sequence control program.
robots controllable by NJ Robotics function	Specify the controllable robots by the data processing for robot in the Motion Control Function Module of the NJ-series CPU Unit. The controllable robot consists of the 1S-series or G5-series Servomotor/Servo Drive with built-in EtherCAT communications and the robot arm that is prepared by the customer.
TCP	A tip (Tool Center Point) defined in each OMRON robot. The target position or path can be specified based on the TCP.
TIO	Refers to digital input and output signals to use arm tip tools for OMRON SCARA robots (i4H, i4L).
V+ keyword	A generic term for instructions that are used during a V+ program and monitoring command.
V+ language	A programming language for OMRON robot control.
V+ task	A task that can execute a V+ program.
V+ program	A control program written in the V+ language.
OMRON robot	Specifies the OMRON robot controllable from the Robot Integrated CPU Unit. The robot consists of the robot amplifier and the robot arm connected to the robot amplifier.
shared variable	A variable that can be shared between the sequence control program and V+ program.
sequence control program	A control program written in IEC 61131-3 language including the motion control.
configured eV+ version	An eV+ version that is set by the eV+ version configuration function. It is set for both the Robot Integrated CPU Unit and an OMRON robot.
hardware servo	A servo system built into the robot amplifier.
user program	A generic term for the collection of programs written in the ladder diagram, ST, and V+ languages.
remote encoder	Specifies the encoder which sets the motion control axis as the external encoder for robot control.
recipe	A set of product type data in the customer's system.
recipe change	Specifies that the product data and information (recipe) related to the production process are changed. The target recipe for the Robot Integrated CPU Unit is a property from the present values of variables and a vision sensor.
local encoder	Specifies the encoder connected to the encoder input port on the OMRON robot.
Robot Control Function Module	Software to perform robot control that is installed in the Robot Integrated CPU Unit.
robot control instructions	FB instructions written in the sequence control program to control the OMRON robots. They include an instruction to directly control the OMRON robots and an instruction to execute or abort V+ programs assigned to the V+ tasks.
Robot Integrated CPU Unit	A CPU Unit that supports control function for the OMRON robot with the NJ-series CPU Unit.

# Revision History

---

A manual revision code appears as a suffix to the catalog number on the front and back covers of the manual.

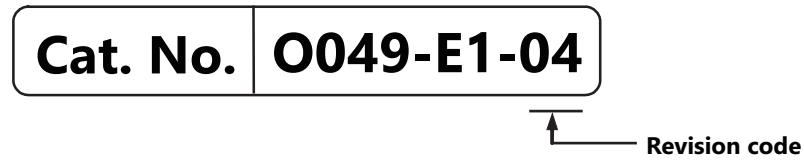

Revision code	Date	Revised content
01	August 2020	Original production
02	December 2020	<ul style="list-style-type: none"><li>• Added description on dynamic pick-and-place equipment.</li><li>• Corrected mistakes.</li></ul>
03	October 2021	Corrected mistakes.
04	March 2022	Corrected mistakes.



# 1

## Overview

This section describes the overview of robot integrated system.

---

<b>1-1</b>	<b>Features of Robot Integrated System .....</b>	<b>1-2</b>
1-1-1	Features of the NJ-series Robot Integrated CPU Unit .....	1-2
1-1-2	Features of the EtherCAT-compatible OMRON robots .....	1-2
1-1-3	Features of the Sysmac Studio Automation Software .....	1-2
<b>1-2</b>	<b>System configuration to build in this guide .....</b>	<b>1-3</b>
<b>1-3</b>	<b>System Configuration for Static Pick-and-place Equipment .....</b>	<b>1-4</b>
<b>1-4</b>	<b>Operations of Static Pick-and-place Equipment .....</b>	<b>1-6</b>
1-4-1	Operating Specifications .....	1-6
1-4-2	Operating Modes for Equipment .....	1-7
<b>1-5</b>	<b>System Configuration for Dynamic Pick-and-place Equipment .....</b>	<b>1-8</b>
<b>1-6</b>	<b>Operations of Dynamic Pick-and-place Equipment .....</b>	<b>1-10</b>
1-6-1	Operating Specifications .....	1-10
1-6-2	Operating Modes for Equipment .....	1-11
<b>1-7</b>	<b>Hardware .....</b>	<b>1-12</b>
<b>1-8</b>	<b>Software .....</b>	<b>1-14</b>
1-8-1	Sysmac Studio .....	1-14
1-8-2	Application Manager .....	1-14
<b>1-9</b>	<b>User Program .....</b>	<b>1-16</b>
1-9-1	Types of Method to Create User Program .....	1-16
1-9-2	Proper Use of Sequence Control Program and V+ Program .....	1-16
1-9-3	Command and Data Flow .....	1-17

# 1-1 Features of Robot Integrated System

The robot integrated system is a system to integrate the sequence control and robot control into a Controller, network, and software.

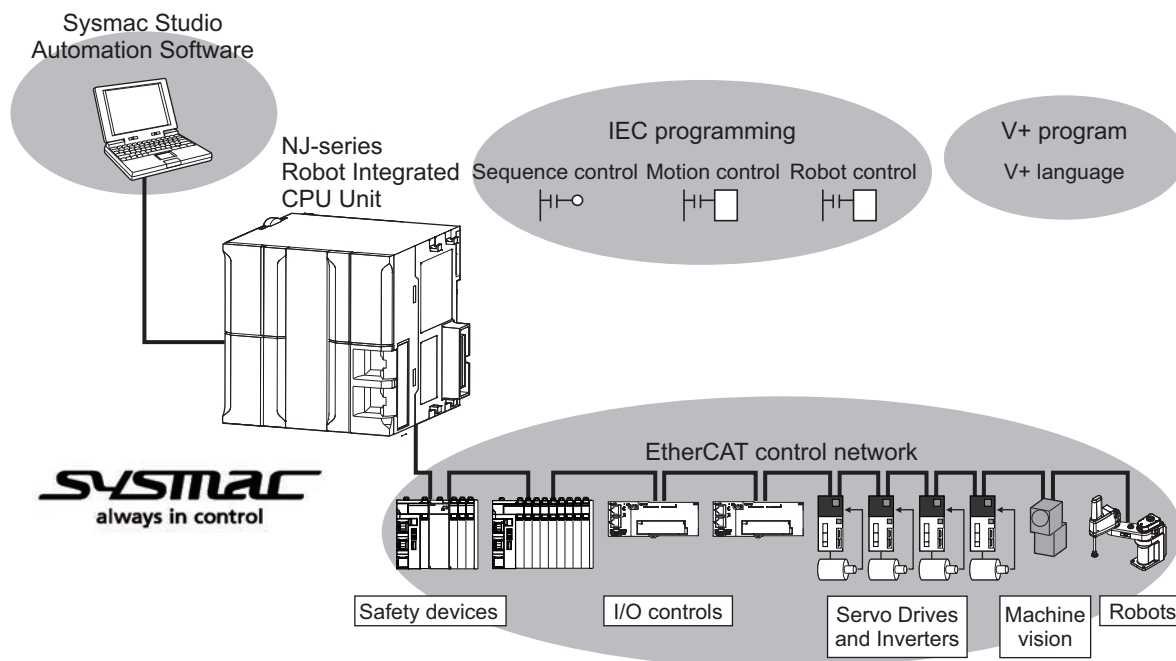

The system consists of the NJ-series Robot Integrated CPU Unit, the OMRON robots that support EtherCAT communications, and the Sysmac Studio Automation Software.

## 1-1-1 Features of the NJ-series Robot Integrated CPU Unit

The sequence control and the robot control can be executed with a CPU Unit. This allows you to design interface easily between the sequence control and robot control and reduce the design time and the adjustment time at startup.

## 1-1-2 Features of the EtherCAT-compatible OMRON robots

The robots and peripheral devices can connect to the same EtherCAT network. The operations for the robots and the peripheral devices can be handled in the same time axis with the synchronization function of the EtherCAT, so wait time for asynchronous operation or variations of timing are reduced. This enables you to reduce the tact time, identify an error cause during operation, and make predictive control for the operations of peripheral devices.

## 1-1-3 Features of the Sysmac Studio Automation Software

The sequence control and the robot control can be developed with a software. It is easy to perform the advance verification on paper because the system operations to use with the sequence control and robot control can be simulated with the 3D model.



## 1-2 System configuration to build in this guide

*NJ-series Robot Integrated System Startup Guide* (hereinafter referred to as “this guide”) describes examples of building a static pick-and-place equipment and a dynamic pick-and-place equipment.

An equipment to move a workpiece that is placed at the specified position to the target position is called a static pick-and-place equipment in this guide.

An equipment that picks up a workpiece being moved on the conveyor and places it at the specified position is called a dynamic pick-and-place equipment. The pickup position is automatically determined from the position detected by the camera and encoder.

To control multiple Omron robots and manage the recipes, IPC Application Controller is connected to the equipment via Ethernet. Select and use the IPC Application Controller, industrial cameras, and belt encoders required for the functions explained in *1-8-2 Application Manager* on page 1-14.

The figure below illustrates the devices to be used for each equipment.

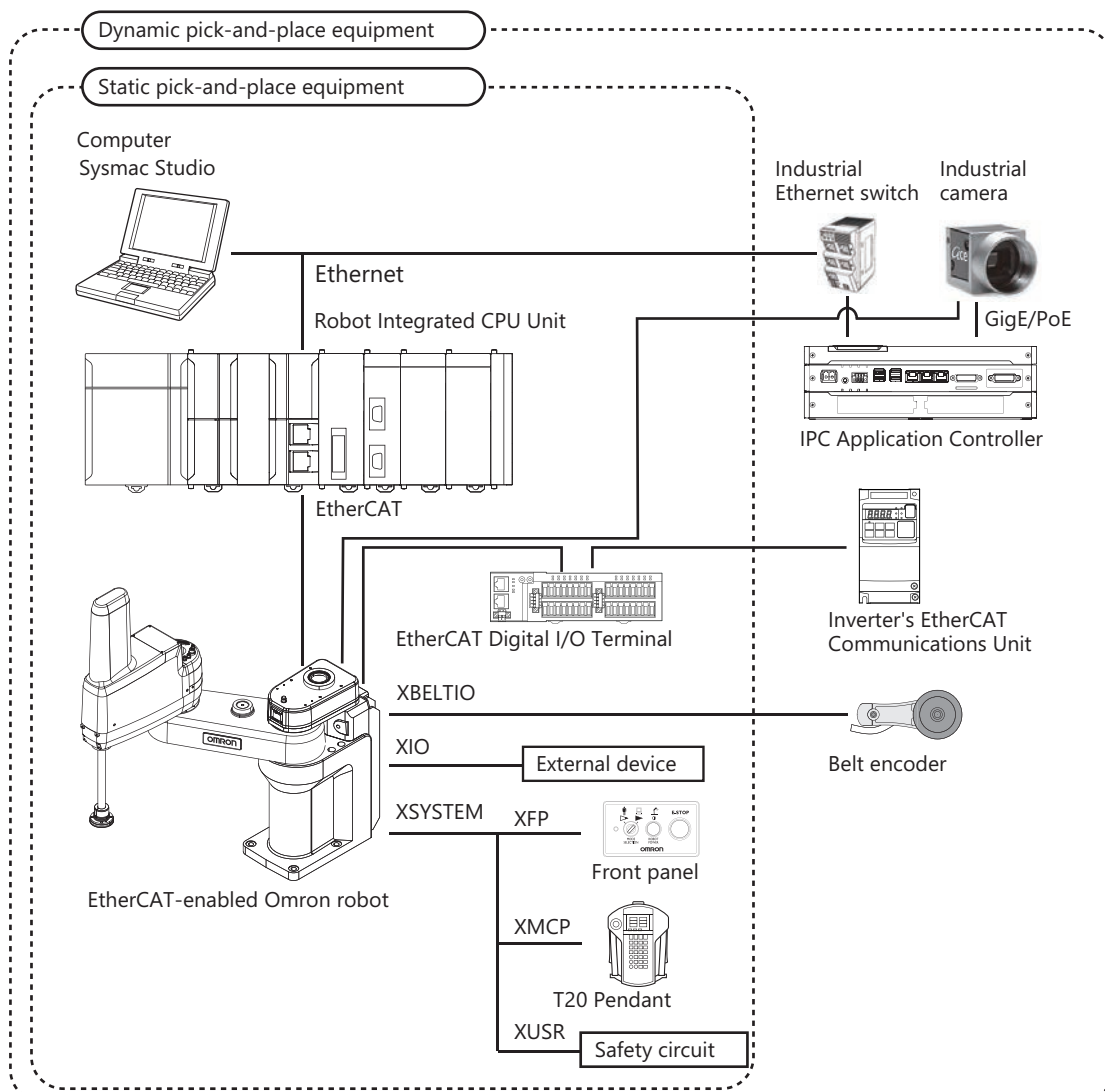

# 1-3 System Configuration for Static Pick-and-place Equipment

This section describes the system configuration for the static pick-and-place equipment that is explained in this guide.

An equipment to move a workpiece that is not moved at the specified position to the target position is called a static pick-and-place equipment in this guide.

"XUSR" in the following figure is a wiring to the safety circuits. Refer to *A-1 Designing Example of the Safety Functions for the Pick-and-place Equipment* on page A-2, and design the safety circuits required for the actual equipments.

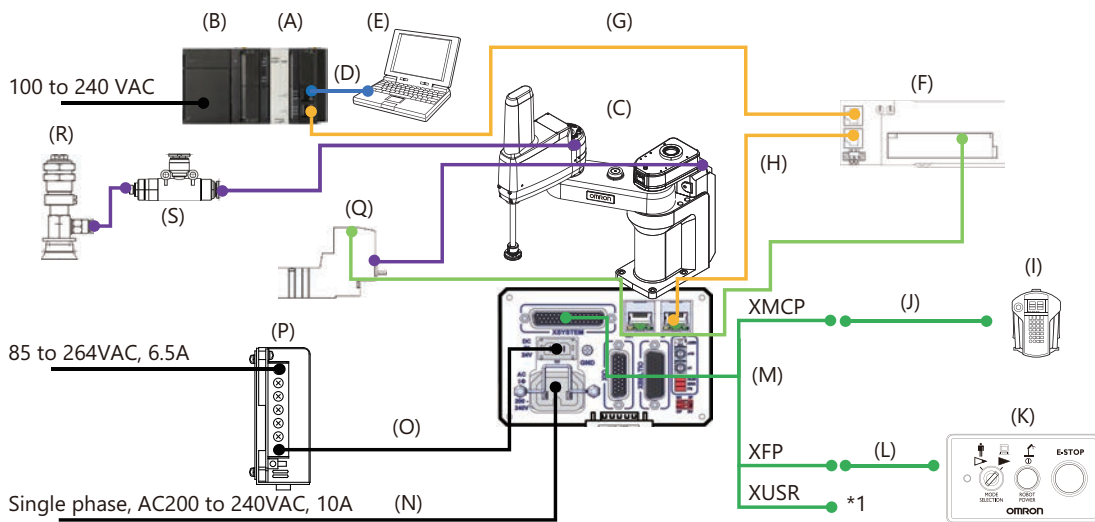

The parts that are used in the system configuration are given below.

Letter	Name	Model	Version
A	Robot Integrated CPU Unit	NJ501-R300	Ver.1.41
B	Power Supply Unit	NJ-PA3001	---
C	SCARA Robot eCobra 600 Pro	RL4-2166000	3.0 0-0 Edit A1
D	Ethernet cable*1	---	---
E	Computer (Sysmac Studio)	---	---
F	EtherCAT Digital I/O Terminal	GX-MD3218	---
G	Ethernet cable*1	---	---
H	Ethernet cable*1	---	---
I	T20 Pendant	10046-010	3.0.0.1
J	T20 Adapter Cable		---
K	Front Panel	90356-10358	---
L	Front Panel Cable		---
M	XSYSTEM Cable Assembly	Includes in the RL4-2166000.	---
N	AC Power Cable	04118-000	---
O	DC Power Cable	04120-000	---
P	24 VDC Power Supply 150 W	S8FS-G15024CD	---
Q	Solenoid valve	Selects depending on the workpiece.	---
R	Vacuum pad		---
S	Vacuum ejector		---

\*1. Use a twisted-pair cable (double shielding with aluminum tape and braiding) of category 5 (100BASE-TX) or higher.

# 1-4 Operations of Static Pick-and-place Equipment

This section describes the operating specifications and procedures for the static pick-and-place equipment.

## 1-4-1 Operating Specifications

This equipment picks up a workpiece that is not moving on the conveyor A and transfers it to the specified position on the conveyor B.

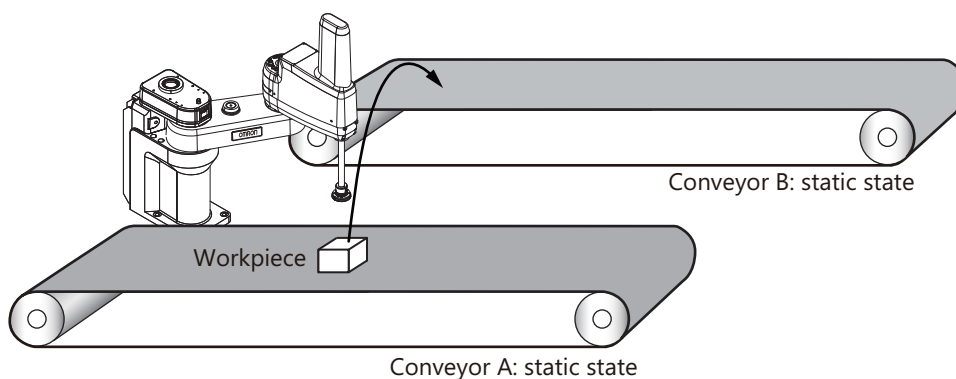

The following figure shows a specific operation for a robot.

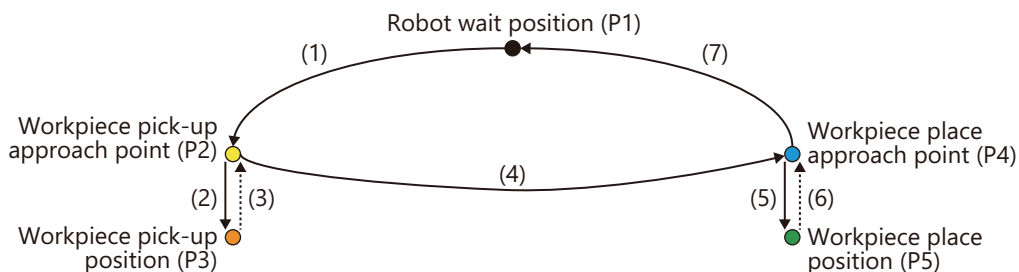

Number	Description of operation
(1)	Move from the robot wait position (P1) to the workpiece pick-up approach point (P2) in joint interpolation operation.
(2)	Move from the workpiece pick-up approach point (P2) to the workpiece pick-up position (P3) in linear interpolation operation.
(3)	Move from the workpiece pick-up position (P3) to workpiece pick-up approach point (P2) in linear interpolation operation.
(4)	Move from the workpiece pick-up approach point (P2) to the workpiece place approach point (P4) in joint interpolation operation.
(5)	Move from the workpiece place approach point (P4) to the workpiece place position (P5) in linear interpolation operation.
(6)	Move from the workpiece place position (P5) to the workpiece place approach point (P4) in linear interpolation operation.
(7)	Move from the workpiece place approach point (P4) to the robot wait position (P1) in joint interpolation operation.



### Additional Information

The operations for conveyor A and B are not described in this guide. Program it by the customer according to the operating specifications of actual equipments.

## 1-4-2 Operating Modes for Equipment

Assume that this equipment have two operating modes, manual operation and automatic operation modes.

Perform teaching in manual operation, and execute the actual pick-and-place operations in automatic operation.

# 1-5 System Configuration for Dynamic Pick-and-place Equipment

This section describes the system configuration for the dynamic pick-and-place equipment to build in this guide.

In this guide, an equipment that picks up a workpiece being moved on the conveyor and places it at the specified position is called a dynamic pick-and-place equipment. The pickup position is automatically determined from the position detected by the camera and encoder.

"XUSR" in the following figure is a wiring to the safety circuits. Design the safety circuits required for the actual equipments.

The Y-adapter cable in the figure below is a cable to connect with the encoders. Since there is only one encoder used in this equipment, connect the encoder extension cable to one side only. No encoder is connected to the other side.

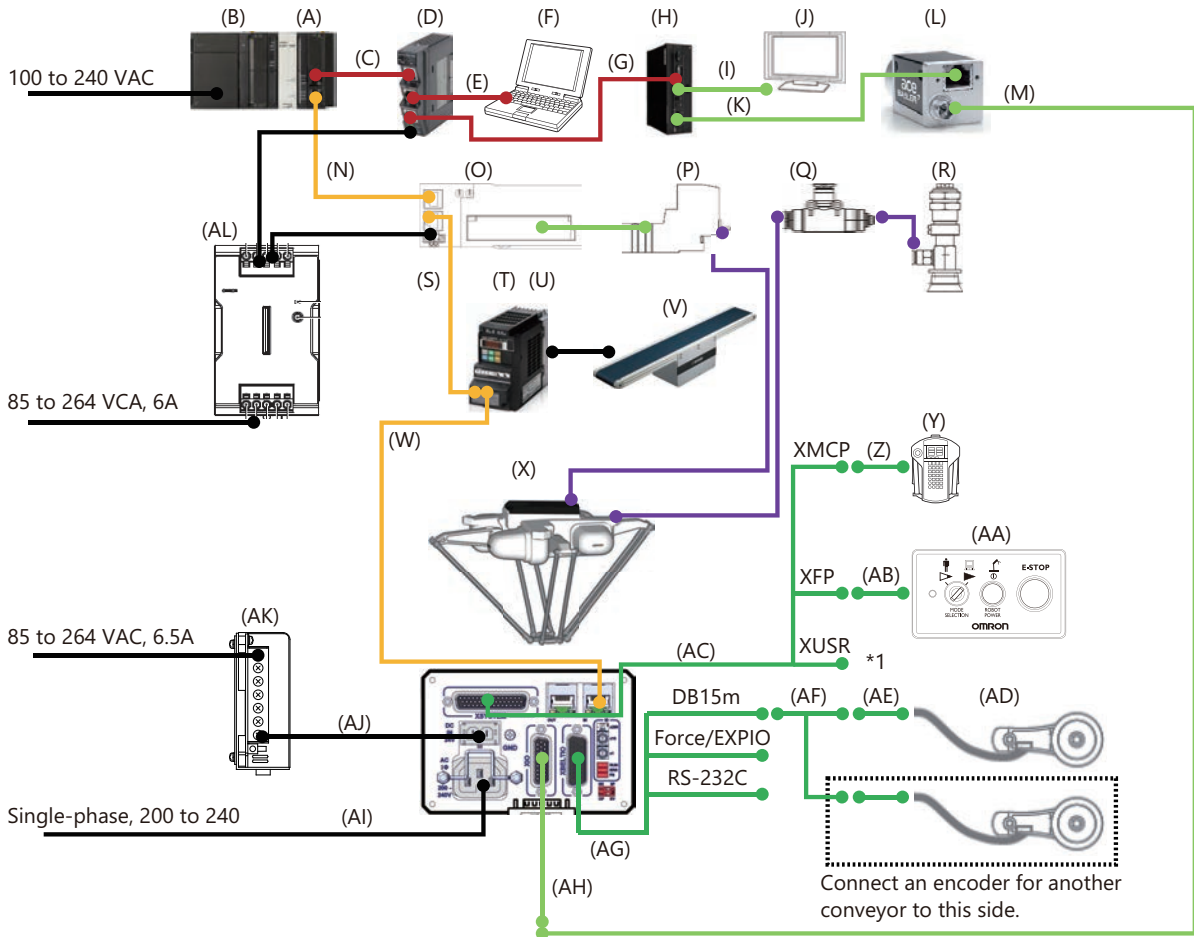

The parts that are used in the system configuration are given below.

Letter	Name	Model	Version
A	Robot Integrated CPU Unit	NJ501-R300	Ver.1.43
B	Power Supply Unit	NJ-PA3001	---
C	Ethernet cable*1	---	---
D	Industrial Ethernet switch	W4S1-03B	---
E	Ethernet cable*1	---	---
F	Computer (Sysmac Studio)	---	---
G	Ethernet cable*1	---	---
H	IPC Application Controller	AC1-152000	Ver.2.00
I	DVI Cable	---	---
J	Display	---	---
K	Camera Cable (GigE Cat.6) 10m	24114*2	---
L	Camera		---
M	Power I/O Cable		---
N	Ethernet cable*1	---	---
O	EtherCAT Digital I/O Terminal	GX-MD3218	---
P	Solenoid valve	Select a bellow-shape valve with suitable vacuum pressure to the workpiece.	---
Q	Vacuum ejector		---
R	Vacuum pad		---
S	Ethernet cable*1	---	---
T	EtherCAT Communications Unit	3G3AX-MX2-ECT	---
U	Inverter*3	Select an applicable model from the Multi-function Compact Inverter MX2-series V1 type.	---
V	Belt conveyor*3	---	---
W	Ethernet cable*1	---	---
X	Parallel Robot iX4 650H, IP65, P30	RX4-2166020	4.0.C1
Y	T20 Pendant	10046-010	3.0.0.1
Z	T20 Adapter Cable		---
AA	Front Panel	90356-10358	---
AB	Front Panel Cable		---
AC	XSYSTEM Cable Assembly	Included in the RL4-2166000.	---
AD	Encoder IP65	09742-001	---
AE	Encoder extension cable 5m		---
AF	Y-Adapter Cable 3m	09443-000	---
AG	XBELT IO Cable 0.6m	13463-000	---
AH	XIO Breakout Cable	04465-000	---
AI	AC Power Cable	04118-000	---
AJ	DC Power Cable	04120-000	---
AK	24 VDC Power Supply 150 W	S8FS-G15024CD	---
AL	24 VDC Power Supply 120W	S8VK-S12024	---

\*1. Use a twisted-pair cable (double shielding with aluminum tape and braiding) of category 5 (100BASE-TX) or higher.

\*2. Select a camera with the appropriate imaging range and resolution for the belt width and the workpiece.

\*3. Refer to the *Multifunction Compact Inverter User's Manual (Cat. No. I585)* for the circuits around the inverter and connection to the belt conveyor.

# 1-6 Operations of Dynamic Pick-and-place Equipment

This section describes the operating specifications and procedures for the dynamic pick-and-place equipment.

## 1-6-1 Operating Specifications

This equipment picks up a workpiece that is moving on the conveyor A after a camera detects it, and places it to the specified position on the conveyor B.

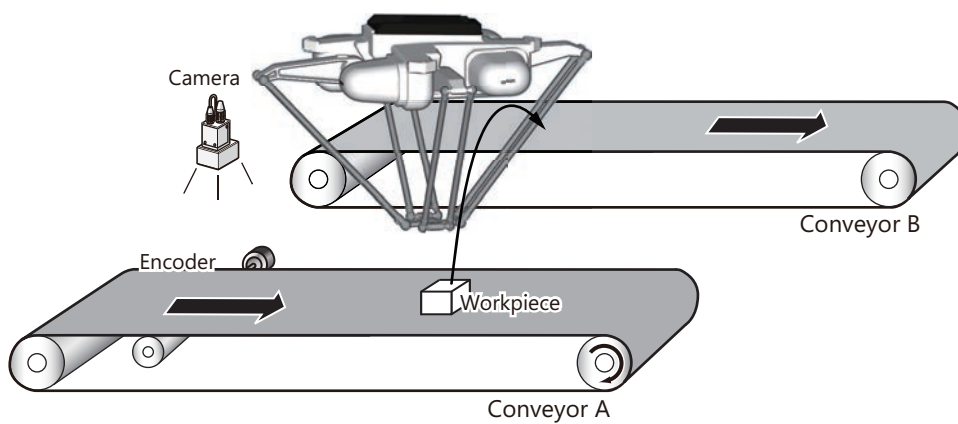

The following figure shows a specific operation for a robot.

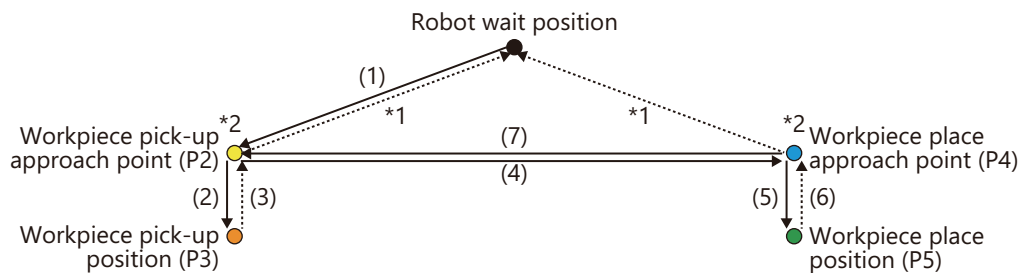

\*1. When there is no workpiece to pick up on the conveyor and no item is detected by the camera, the robot once moves from the workpiece pick-up approach point (P2) or workpiece pick-up position (P3) to the robot wait position (P1). While the camera is detecting the workpiece, operation from (2) to (7) is repeatedly performed.

\*2. In above operation digram, both of the transit points of the robot in approaching to the workpiece and departing from the workpiece are called "workpiece pick-up approach point (P2)". The function of the Pack Manager allows you to set the transit positions in approaching to the workpiece and moving away from the workpiece to different locations. Similarly, you can set different locations for "workpiece place approach point (P4)".

Number	Description of operation
(1)	Move from the robot wait position (P1) to the workpiece pick-up approach point (P2) in linear interpolation operation.



Number	Description of operation
(2)	Move from the workpiece pick-up approach point (P2) to the workpiece pick-up position (P3) in linear interpolation operation.
(3)	Move from the workpiece pick-up position (P3) to workpiece pick-up approach point (P2) in linear interpolation operation.
(4)	Move from the workpiece pick-up approach point (P2) to the workpiece place approach point (P4) in linear interpolation operation.
(5)	Move from the workpiece place approach point (P4) to the workpiece place position (P5) in linear interpolation operation.
(6)	Move from the workpiece place position (P5) to the workpiece place approach point (P4) in linear interpolation operation.
(7)	Move from the workpiece place approach point (P4) to the workpiece pick-up approach point (P2) in linear interpolation operation.

The "approach point" is the same as "approach location" and "depart location" that are used with the Pack Manager described in *4-3-6 Creating a Pack Manager Sample* on page 4-53.



#### Additional Information

The operations for conveyor B are not described in this guide. Program it by the customer according to the operating specifications of actual equipment.

## 1-6-2 Operating Modes for Equipment

Assume that this equipment have two operating modes, manual operation and automatic operation modes.

Perform teaching in manual operation, and execute the actual pick-and-place operations in automatic operation.

# 1-7 Hardware

The following table shows an overview of each hardware in the system configuration. Refer to the manual for the specific product for details.

Hardware	Model	Description	Static	Dy- na- mic
Robot Integrated CPU Unit	NJ501-R□□□	A CPU Unit that integrates the sequence control and robot control. To use the robot control function, you must insert the included SD Memory Card.	○	○
EtherCAT-compatible OMRON robot	RL□-□□□□□□□	OMRON's SCARA robot that supports EtherCAT.	○	○
	RX□-□□□□□□□	OMRON's parallel robot that supports EtherCAT.	○	○
Computer	---	A computer that the Sysmac Studio Automation Software to make the settings for the robot integrated system and perform debugging is installed. *1	○	○
Front Panel	90356-10358	A control panel for a robot. The panel has switches to change modes, enable the high power, and make a emergency stop.	○	○
T20 Pendant	10046-010	A teaching pendant for a robot. Use the pendant for teaching coordinates. It has the built-in E-Stop button and built-in enable switch as safety functions.	○	○
Safety circuits	---	The safety circuits that consist of safety I/O devices, a Safety Controller, etc. Refer to <i>A-1 Designing Example of the Safety Functions for the Pick-and-place Equipment</i> on page A-2 for details.	○	○
Connected external devices	---	I/O devices connected to the digital I/O terminals of the robot.	○	○
EtherCAT slaves	---	EtherCAT slaves such as digital I/O, servos, and inverters.	○	○
Industrial Ethernet switch	W4S1-□□□	This is used for branching the Ethernet network.	---	○
IPC Application Controller	AC1-152000	An industrial computer. The computer executes pre-installed softwares for the robot control system (Application Manager). It has a interface for connecting a camera (PoE port).	---	○
Industrial camera	24114-□□□	A camera for sensing an image. The camera can connect to the IPC Application Controller to detect and inspect a workpiece.	---	○
Inverter	3G3MX2-A□□□□-V1	An inverter to control a belt conveyor. Select an applicable model from the Multi-function Compact Inverter MX2-series V1 type.	---	○
EtherCAT Communications Unit	3G3AX-MX2-ECT	A communications unit to be attached for EtherCAT communications.	---	○

Hardware	Model	Description	Static	Dy- na- mic
Conveyor Belt	SVKN-100-1000-25- T100-IM-9-H-A	A belt conveyor of MISUMI Corporation for conveying workpieces.	---	○
Encoder kit IP65	09742-001	An encoder mounted on the belt conveyor.	---	○

- \*1. Refer to the *Sysmac Studio Robot Integrated System Building Function with Robot Integrated CPU Unit Operation Manual (Cat. No. W595)* for information on the recommended operating environment for the computer.

# 1-8 Software

This section describes an overview of each software in the system configuration.

Use the Sysmac Studio as a development environment for the robot integrated system and Application Manager as a runtime to control the application.

## 1-8-1 Sysmac Studio

The Sysmac Studio provides development environment for a robot integrated system on a computer.



### Precautions for Correct Use

For a robot integrated system, use the 64-bit edition DVD (SYSMAC-SE200D-64) with the Sysmac Studio version 1.□□. You cannot use the 32-bit edition DVD (SYSMAC-SE200D).

The Sysmac Studio has the following functions.

Function	Description
Robot control function	A function to make settings and create a program to control a robot with the Robot Integrated CPU Unit and IPC Application Controller. To use this function, you need a license for the Standard Edition (SYSMAC-SE2□□L).
3D simulation function	A function to perform a 3D simulation including robots and peripheral devices. To use this function, you need a license with the 3D Simulation Option (SYSMAC-SA4□□L-64).

Refer to the *Sysmac Studio Robot Integrated System Building Function with Robot Integrated CPU Unit Operation Manual (Cat. No. W595)* for information on the robot control function in the Sysmac Studio and the *Sysmac Studio 3D Simulation Function Operation Manual (Cat. No. W618)* for information on the 3D simulation function.



### Additional Information

Refer to *A-3 Setting Items on the Sysmac Studio and the Setting Targets* on page A-28 for information on which hardware setting corresponds to the items on the Multiview Explorer of the Sysmac Studio.

## 1-8-2 Application Manager

The Application Manager is one of the functions for ACE that is a software pre-installed in the IPC Application Controller.

The Application Manager has following functions.

Function	Description
Process Manager	Determines which robot will use for a workpiece automatically, and performs the variance of loads.
Recipe Manager	Manages the robot control parameters for the product type change of a workpiece.
Robot Vision Manager	Detects a workpiece position and inspect the appearance by sensing an image with a camera. To enable this function, you must mount the USB Dongle (20410-000 or 20433-000) on the IPC Application Controller.
Pack Manager	Executes packing applications that are created in the application sample. To enable this function, you must mount the USB Dongle (20409-000 or 20433-000) on the IPC Application Controller.



### Precautions for Correct Use

---

The ACE has a function as a development environment of a robot system with the Smart Controller EX, but it cannot be used as a development environment of a robot integrated system. Use the Sysmac Studio to develop the robot integrated system.

---

# 1-9 User Program

The user program for robot control is created in the Sysmac Studio.

There is more than one method to create a user program. Realize applications to use with programs created by multiple methods.

## 1-9-1 Types of Method to Create User Program

The following table shows the types of method to create a user program.

Method	Description
Sequence control program	The user program that is operated in the Robot Integrated CPU Unit can be programmed with the language that is defined in IEC61131-3. The robots are controlled with robot control instructions and system-defined variables for robot control. This program is suitable for operating simple robot motions or controlling with robots and peripheral devices. Ladder diagram is used in this guide.
V+ program	The user program that is operated in the Robot Integrated CPU Unit can be programmed with V+ language. The language is a programming language for robot control for the OMRON robots. The robots can be controlled using V+ keywords. In addition, you can use ACE Sight V+ keywords and V+ module API to call and use the functions of the Application Manager. This program is suitable for using various robot control.
C# program	The user program that is operated in the IPC Application Controller can be programmed with C# language. Use this program when the functions of the Application Manager are called and used.
Application sample	You can create an application sample on the interactive setup wizard. The application sample includes the settings and programs for the IPC Application Controller and Robot Integrated CPU Unit. The Pack Manager sample is used in this guide.

## 1-9-2 Proper Use of Sequence Control Program and V+ Program

The following shows proper use of the sequence control program and V+ program.

- The sequence control program manages the status, errors, and interlocks of the entire system including sequence control and robot control.
- The robot control is performed with a combination of the sequence control program and the V+ program.
- The sequence control program performs the control other than robot control.

A typical example of differences for robot control that can be used in the sequence control program and the V+ program is given below.

The sequence control program can use a part of the control that is available in the V+ program.

Classification	Item	Applicability ( if applicable, the specified method is described.)	
		Sequence control program	V+ program
Robot operations	Joint interpolation operation	RC_MoveDirect *1	MOVE
	Linear interpolation operation	RC_MoveLinear *1	MOVES
	Circular interpolation operation	Not possible.	MOVEC
	Jog operation	Not possible.	JOG
	Joint coordinate system operation	Not possible.	JMOVE
	Tool coordinate system operation	Not possible.	APPRO/DEPART/ ALIGN
Robot's coordinate	Flange surface	_RC_RBT[*].TCPActPos *2	HERE
	Coordinates of the tool center point	_RC_RBT[*].TCPActPos *2 (RC_SetToolTransform *1)	HERE (TOOL)
	Joint coordinates for each axis	_RC_RBT[*].JointActPos *2	#PHERE
Other functions	Robot built-in I/O	_RC_RBT_IO[*].XIO *2	SIGNAL/SIG
	Expanded robot I/O	_RC_RBT_IO[*].IOBlox1 *2 _RC_RBT_IO[*].IOBlox2 *2	SIGNAL/SIG
	Teaching	Not possible.	Position variables
	End effector operation	_RC_RBT_IO[*].RO *2	SIGNAL/SIG
	Robot position latching	Not possible.	LATCH
	Local encoder latch	Not possible.	DEVICE
	Cooperation with Application Manager	Not possible.	ACE Sight V+ keyword V+ Module API

\*1. This is a robot control instruction.

\*2. This is a system-defined variable for robot control.

Refer to the *NJ-series Robot Integrated CPU Unit User's Manual (Cat. No. O037)* for detailed information when a robot is controlled with a sequence control program.

Refer to the *eV+3 User's Manual (Cat. No. I651)* and *eV+3 Keyword Reference Manual (Cat. No. I652)* for detailed information when a robot is controlled with a V+ program.

## 1-9-3 Command and Data Flow

This section describes the flow of commands and data for the sequence control program, V+ program, Application Manager, and robot.

The sequence control program can control robots with robot control instructions, robot variables, and robot I/O variables.

Since the taught position data is stored in the position variable of the V+ program, to use it in the sequence control program, V+ programs need to be called from RC\_ExecVpPrgTask and the position data must be copied to the shared variables.

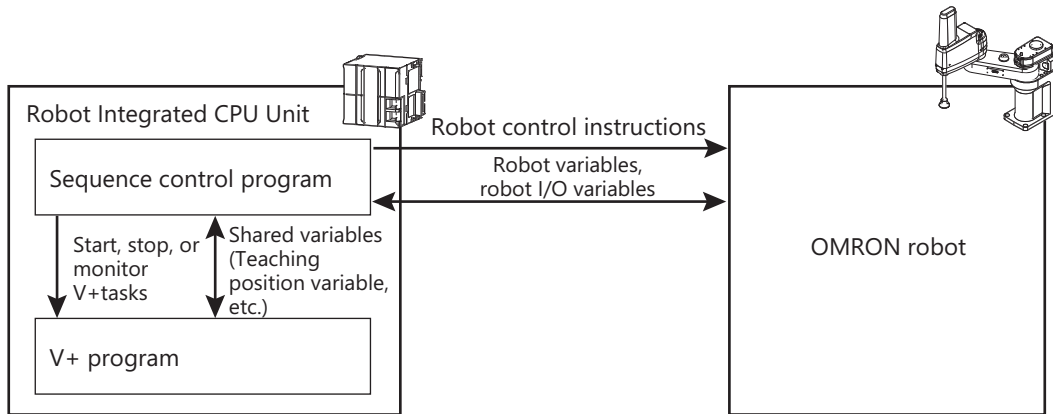

The V+ program can control robots with V+ keywords, signal numbers, and V+ variables. In addition, the V+ program can execute the functions of the Application Manager in the IPC Application Controller with ACE Sight V+ keywords and V+ module API. The V+ program is launched and stopped by RC\_ExecVpPrgTask from the sequence control program.

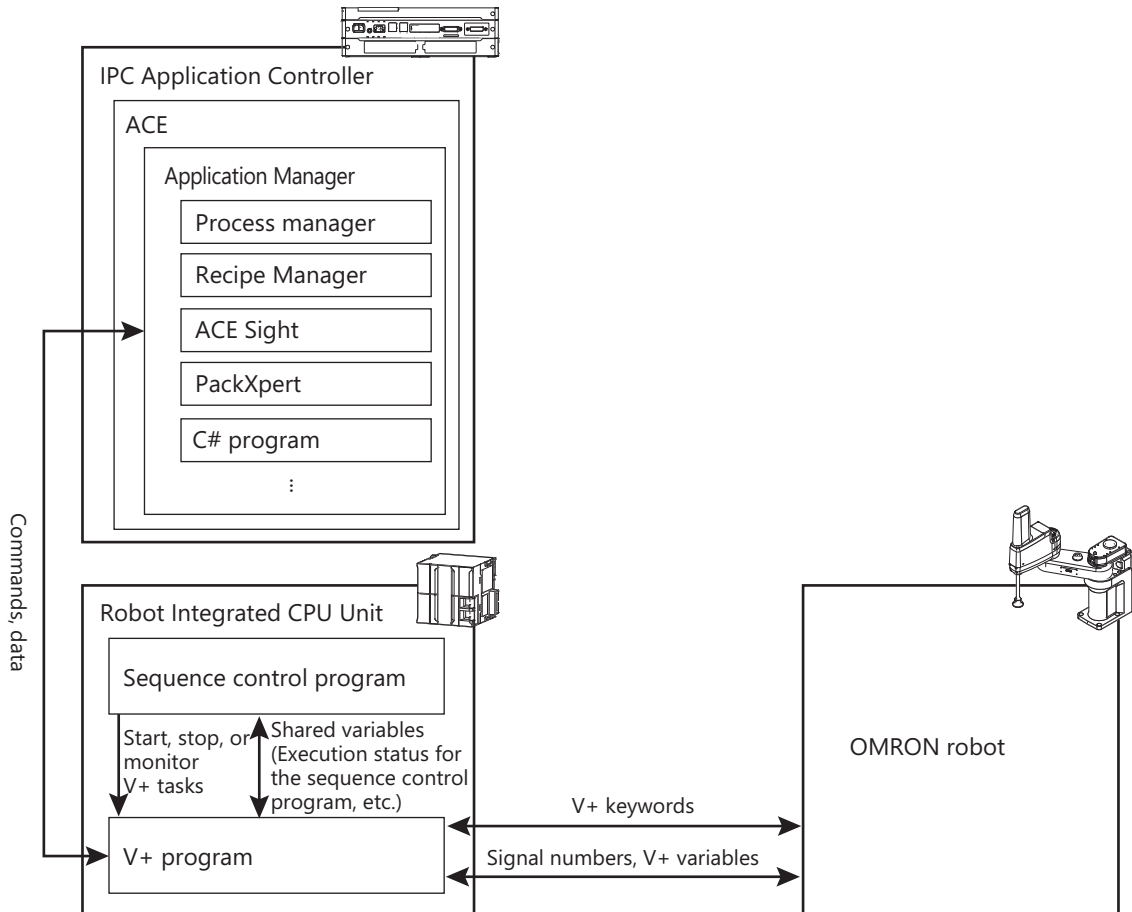

Refer to the *NJ-series Robot Integrated CPU Unit User's Manual (Cat. No. O037)* for details on the robot control function and shared variables in the sequence control program. Refer to the *eV+3 User's Manual (Cat. No. I651)* and *eV+3 Keyword Reference Manual (Cat. No. I652)* for details on the robot control function in the V+ program.





# Before You Begin

This section describes the installation procedure of the Sysmac Studio.

---

2-1	Installing the Sysmac Studio .....	2-2
-----	------------------------------------	-----

## 2-1 Installing the Sysmac Studio

---

The Sysmac Studio Ver.1.□□ 64-bit edition DVD (SYSMAC-SE200D-64) is the Support Software that you use for the Robot Integrated System. On it, you can set up the configurations and parameters, you can create programs, and you can debug and simulate operation.

- 1** Set the Sysmac Studio installation disk into the DVD-ROM drive.  
The setup program is started automatically and the **Select Setup Language** Dialog Box is displayed.
- 2** Select the language to use, and then click the **OK** button.  
The Sysmac Studio Setup Wizard is started.
- 3** Follow the instructions given by the Setup Wizard to complete the installation.
- 4** Restart the computer when the installation is completed.



---

### Additional Information

- Refer to the *Sysmac Studio Robot Integrated System Building Function with Robot Integrated CPU Unit Operation Manual (Cat. No. W595)* for information on the system requirements for the computer to which you install the Sysmac Studio.
  - Refer to the *Sysmac Studio Version 1 Operation Manual (Cat. No. W504)* if you are unable to install the Sysmac Studio with the above instructions.
-

# 3

## Implementation Example of Static Pick-and-place Equipment

This section describes the implementation example of the static pick-and-place equipment.

An equipment to move a workpiece that is not moved at the specified position to the target position is called a static pick-and-place equipment in this guide.

This example can realize with the sequence control program and V+ program.

---

<b>3-1</b>	<b>Program Specifications for Static Pick-and-place Equipment .....</b>	<b>3-2</b>
3-1-1	When Operations are Controlled with Sequence Control Program .....	3-3
3-1-2	When Operations are Controlled with V+ Program .....	3-10
<b>3-2</b>	<b>Basic Startup Procedures .....</b>	<b>3-17</b>
<b>3-3</b>	<b>Programming and Simulation Procedures .....</b>	<b>3-19</b>
3-3-1	Creating a Project File .....	3-19
3-3-2	Creating the EtherCAT Network Configuration .....	3-20
3-3-3	Creating a Sequence Control Program .....	3-22
3-3-4	Creating V+ Programs .....	3-28
3-3-5	Placing 3D Shape Data .....	3-35
3-3-6	Starting Simulation .....	3-65
3-3-7	Teaching Positions .....	3-66
3-3-8	Setting up Automatic Loading of V+ Programs and Variables at Power ON ..	3-77
3-3-9	Running the Program and Checking Operation .....	3-81
<b>3-4</b>	<b>Installing and Wiring the System .....</b>	<b>3-86</b>
3-4-1	Wiring the Robot Integrated CPU Unit and the EtherCAT Digital I/O Terminal .....	3-86
3-4-2	Setting the Node Address of the EtherCAT Digital I/O Terminal .....	3-87
3-4-3	Wiring the EtherCAT Digital I/O Terminal and the Robot .....	3-87
3-4-4	Setting the EtherCAT Node Address of the Robot .....	3-88
3-4-5	Wiring the Robot Integrated CPU Unit and the Computer .....	3-88
3-4-6	Wiring the Robot, T20 Pendant and the Front Panel .....	3-89
3-4-7	Wiring the EtherCAT Digital I/O Terminal and Solenoid Valve .....	3-90
<b>3-5</b>	<b>Setup Procedure for Actual System .....</b>	<b>3-92</b>
3-5-1	Connecting Online .....	3-92
3-5-2	Transferring Settings and Programs .....	3-94
3-5-3	Teaching .....	3-96
3-5-4	Executing Program to Check Operation .....	3-108

## 3-1 Program Specifications for Static Pick-and-place Equipment

The program specifications are described if operations of static pick-and-place equipment are controlled with the sequence control program and if the operations are controlled with the V+ program. A flow chart of a program is given below. Refer to *1-4-1 Operating Specifications* on page 1-6 for information on the positions of P1 to P5 in the flow chart.

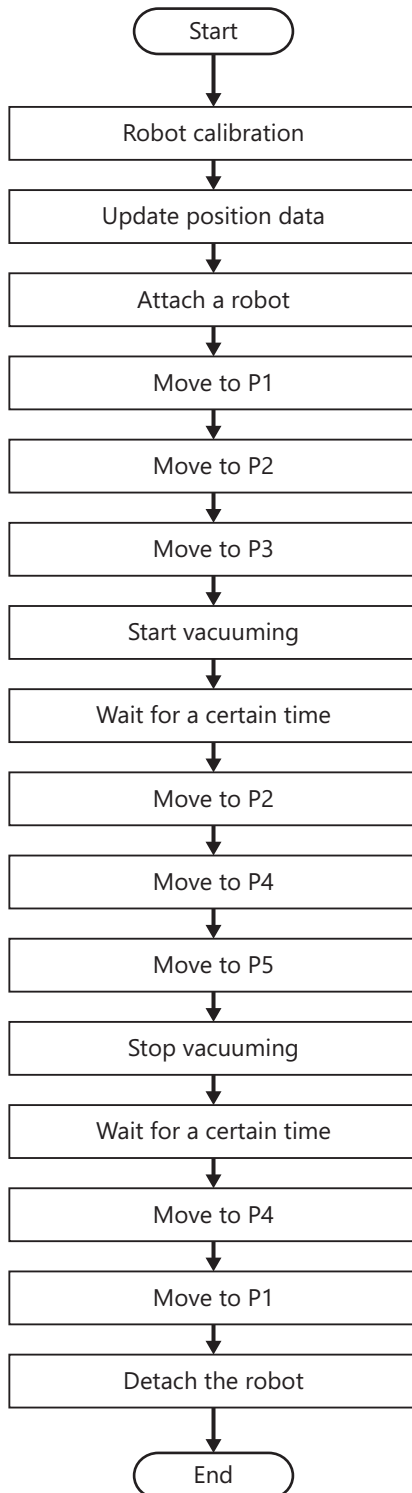

There are two ways to program the static pick-and-place equipment; one is to control with a sequence control program, and the other is to control with a V+ program. Create the program in either way. For information on how to create a program, refer to *3-3 Programming and Simulation Procedures* on page 3-19.

### 3-1-1 When Operations are Controlled with Sequence Control Program

The program specifications when operations of static pick-and-place equipment are controlled with the sequence control program are described below.

The program consists of the following programs.

Program name	Language	Description
Main	Sequence control program (Ladder diagram)	Main program
Run	Sequence control program (Ladder diagram)	Operating program
loccopy	V+ program	Variable copy program

#### Shared Variables

The following table shows a list of shared variables that are used in this program.

No.	Variable name	Data type	Description
1	eLoc_Wait	ARRAY[0..5] OF LREAL	Use the variable to send the robot wait position from the V+ program to the sequence control program.
2	eLoc_Place	ARRAY[0..5] OF LREAL	Use the variable to send the robot place position from the V+ program to the sequence control program.
3	eLoc_Pick	ARRAY[0..5] OF LREAL	Use the variable to send the robot pick-up position from the V+ program to the sequence control program.
4	eBool_Exe	BOOL	Use the variable to check that the execution of a V+ task is started in the sequence control program.

#### Sequence Control Program

This section describes the sequence control program to control the static pick-and-place equipment. The sequence control program is used to register global variables and create two programs, "Main" (main program) and "Run" (operating program).

##### ● Global Variables

Register the global variables that are used in the sequence control program.

Name	Data Type	Initial Value	AT	Retain	Constant	Network Publish	Comment
RC_Robot001	_sRC_RBT_REF		RC://_RC_RBT[	<input type="checkbox"/>	<input checked="" type="checkbox"/>	Do not publish ▼	
RC_Robot001_IO	_sRC_RBT_IO_REF		RC://_RC_RBT_	<input type="checkbox"/>	<input type="checkbox"/>	Do not publish ▼	
E001_Write_output_1st_word	WORD		ECAT://node#	<input type="checkbox"/>	<input type="checkbox"/>	Do not publish ▼	
E001_Read_input_1st_word	WORD		ECAT://node#	<input type="checkbox"/>	<input type="checkbox"/>	Do not publish ▼	
E001_Sysmac_Error_Status	BYTE		ECAT://node#	<input type="checkbox"/>	<input type="checkbox"/>	Do not publish ▼	
E001_Out_Bit00	BOOL			<input type="checkbox"/>	<input type="checkbox"/>	Do not publish ▼	4001
E001_Out_Bit01	BOOL		ECAT://node#	<input type="checkbox"/>	<input type="checkbox"/>	Do not publish ▼	
E001_Out_Bit02	BOOL		ECAT://node#	<input type="checkbox"/>	<input type="checkbox"/>	Do not publish ▼	
E001_Out_Bit03	BOOL		ECAT://node#	<input type="checkbox"/>	<input type="checkbox"/>	Do not publish ▼	
E001_Out_Bit04	BOOL		ECAT://node#	<input type="checkbox"/>	<input type="checkbox"/>	Do not publish ▼	
E001_Out_Bit05	BOOL		ECAT://node#	<input type="checkbox"/>	<input type="checkbox"/>	Do not publish ▼	
E001_Out_Bit06	BOOL		ECAT://node#	<input type="checkbox"/>	<input type="checkbox"/>	Do not publish ▼	
E001_Out_Bit07	BOOL		ECAT://node#	<input type="checkbox"/>	<input type="checkbox"/>	Do not publish ▼	
E001_Out_Bit08	BOOL		ECAT://node#	<input type="checkbox"/>	<input type="checkbox"/>	Do not publish ▼	
E001_Out_Bit09	BOOL		ECAT://node#	<input type="checkbox"/>	<input type="checkbox"/>	Do not publish ▼	
E001_Out_Bit10	BOOL		ECAT://node#	<input type="checkbox"/>	<input type="checkbox"/>	Do not publish ▼	
E001_Out_Bit11	BOOL		ECAT://node#	<input type="checkbox"/>	<input type="checkbox"/>	Do not publish ▼	
E001_Out_Bit12	BOOL		ECAT://node#	<input type="checkbox"/>	<input type="checkbox"/>	Do not publish ▼	
E001_Out_Bit13	BOOL		ECAT://node#	<input type="checkbox"/>	<input type="checkbox"/>	Do not publish ▼	
E001_Out_Bit14	BOOL		ECAT://node#	<input type="checkbox"/>	<input type="checkbox"/>	Do not publish ▼	
E001_Out_Bit15	BOOL		ECAT://node#	<input type="checkbox"/>	<input type="checkbox"/>	Do not publish ▼	
E001_In_Bit00	BOOL			<input type="checkbox"/>	<input type="checkbox"/>	Do not publish ▼	
E001_In_Bit01	BOOL			<input type="checkbox"/>	<input type="checkbox"/>	Do not publish ▼	
E001_In_Bit02	BOOL			<input type="checkbox"/>	<input type="checkbox"/>	Do not publish ▼	
E001_In_Bit03	BOOL		ECAT://node#	<input type="checkbox"/>	<input type="checkbox"/>	Do not publish ▼	
E001_In_Bit04	BOOL		ECAT://node#	<input type="checkbox"/>	<input type="checkbox"/>	Do not publish ▼	
E001_In_Bit05	BOOL		ECAT://node#	<input type="checkbox"/>	<input type="checkbox"/>	Do not publish ▼	
E001_In_Bit06	BOOL		ECAT://node#	<input type="checkbox"/>	<input type="checkbox"/>	Do not publish ▼	
E001_In_Bit07	BOOL		ECAT://node#	<input type="checkbox"/>	<input type="checkbox"/>	Do not publish ▼	
E001_In_Bit08	BOOL		ECAT://node#	<input type="checkbox"/>	<input type="checkbox"/>	Do not publish ▼	
E001_In_Bit09	BOOL		ECAT://node#	<input type="checkbox"/>	<input type="checkbox"/>	Do not publish ▼	
E001_In_Bit10	BOOL		ECAT://node#	<input type="checkbox"/>	<input type="checkbox"/>	Do not publish ▼	
E001_In_Bit11	BOOL		ECAT://node#	<input type="checkbox"/>	<input type="checkbox"/>	Do not publish ▼	
E001_In_Bit12	BOOL		ECAT://node#	<input type="checkbox"/>	<input type="checkbox"/>	Do not publish ▼	
E001_In_Bit13	BOOL		ECAT://node#	<input type="checkbox"/>	<input type="checkbox"/>	Do not publish ▼	
E001_In_Bit14	BOOL		ECAT://node#	<input type="checkbox"/>	<input type="checkbox"/>	Do not publish ▼	
E001_In_Bit15	BOOL		ECAT://node#	<input type="checkbox"/>	<input type="checkbox"/>	Do not publish ▼	
E001_Observation	BOOL		ECAT://node#	<input type="checkbox"/>	<input type="checkbox"/>	Do not publish ▼	
E001_Minor_Fault	BOOL		ECAT://node#	<input type="checkbox"/>	<input type="checkbox"/>	Do not publish ▼	
eBool_Exec	BOOL			<input type="checkbox"/>	<input type="checkbox"/>	Do not publish ▼	Start V+ program
eLoc_Pick	ARRAY[0..5] OF LREAL			<input type="checkbox"/>	<input type="checkbox"/>	Do not publish ▼	Pickup position
eLoc_Place	ARRAY[0..5] OF LREAL			<input type="checkbox"/>	<input type="checkbox"/>	Do not publish ▼	Place position
eLoc_Wait	ARRAY[0..5] OF LREAL			<input type="checkbox"/>	<input type="checkbox"/>	Do not publish ▼	Wait position
gStart	BOOL		ECAT://node#	<input type="checkbox"/>	<input type="checkbox"/>	Do not publish ▼	Auto-operation start button
gReset	BOOL		ECAT://node#	<input type="checkbox"/>	<input type="checkbox"/>	Do not publish ▼	Auto-operation stop button
gAutoOn	BOOL			<input type="checkbox"/>	<input type="checkbox"/>	Do not publish ▼	Auto-operation
gAutoRun	BOOL			<input type="checkbox"/>	<input type="checkbox"/>	Do not publish ▼	Start auto-operation
gPosDataOK	BOOL			<input type="checkbox"/>	<input type="checkbox"/>	Do not publish ▼	Position data updated
gRC_Err	BOOL			<input type="checkbox"/>	<input type="checkbox"/>	Do not publish ▼	Robot control error
gSuctionOff	BOOL			<input type="checkbox"/>	<input type="checkbox"/>	Do not publish ▼	Suction OFF
gSuctionOn	BOOL			<input type="checkbox"/>	<input type="checkbox"/>	Do not publish ▼	Suction ON
gSysOK	BOOL			<input type="checkbox"/>	<input type="checkbox"/>	Do not publish ▼	Operation ready
gTaskStatus	INT			<input type="checkbox"/>	<input type="checkbox"/>	Do not publish ▼	Task status
gCalib	BOOL		ECAT://node#	<input type="checkbox"/>	<input type="checkbox"/>	Do not publish ▼	Calibration start button

#### ● Main program (Main)

"Main" (main program) is used to monitor the status of the following robots and EtherCAT Digital I/O Terminals and determine whether the automatic operation can start.

Refer to the manual for each device for details on variables.

No.	Variable name	Description
1	_EC_PDslavTbl[1]	Check that the communications of the EtherCAT Digital I/O Terminal are established.
2	_RC_RBT[0].DrvStatus.Run-Mode	Check that the communications between the Robot Integrated CPU Unit and the robot are established.
3	GetRCErr	Check whether an error caused by the Robot Control Function Module exists.

No.	Variable name	Description
4	_RC_RBT[0].DrvStatus.ESTOP	Check whether the robot is in ESTOP state.
5	_RC_RBT[0].DrvStatus.Manual	Check that the operating mode of the robot is Manual mode.
6	_RC_RBT[0].DrvStatus.Power-Enabled	Check that the robot high power is enabled.

A program is described below.

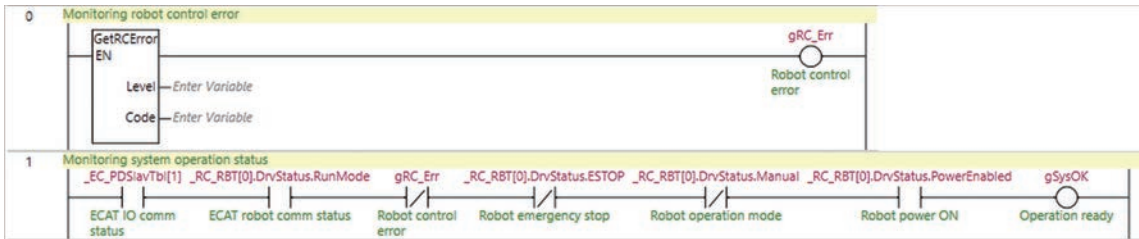

● **Operating program (Run)**

"Run" (operating program) is used to operate a robot.

A program is described below.

### 3 Implementation Example of Static Pick-and-place Equipment

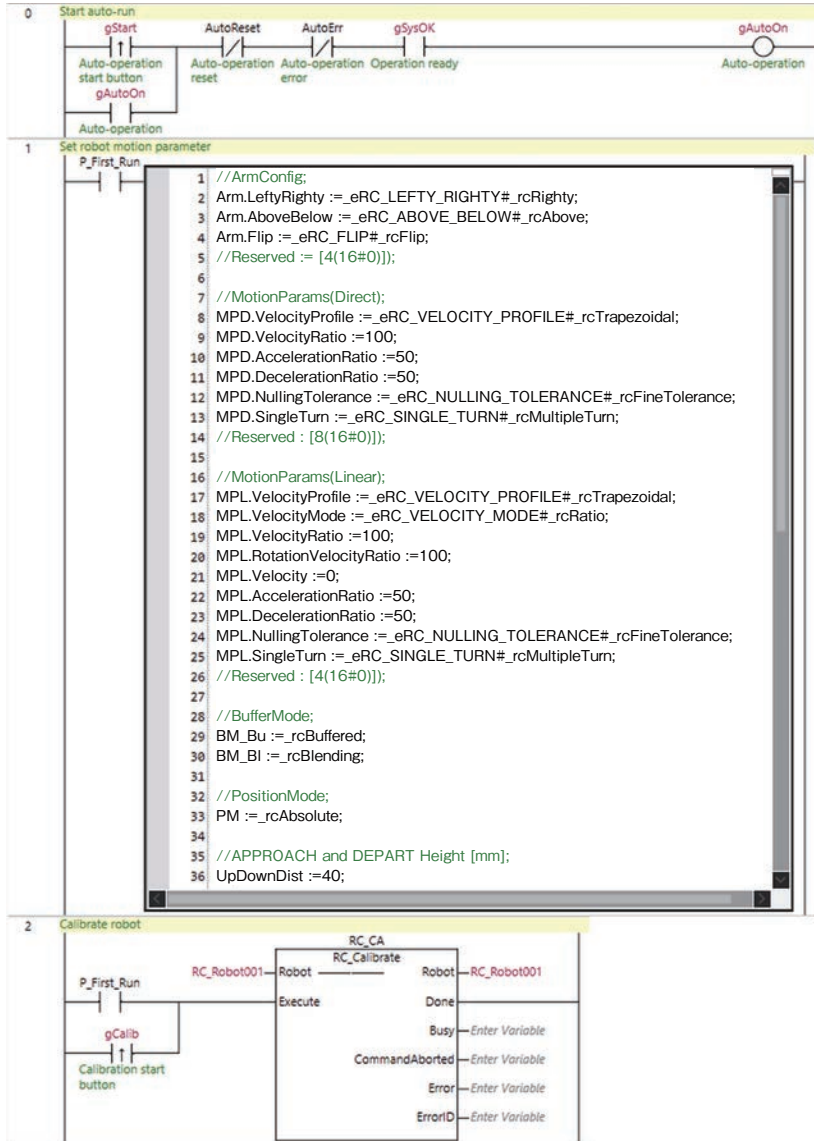



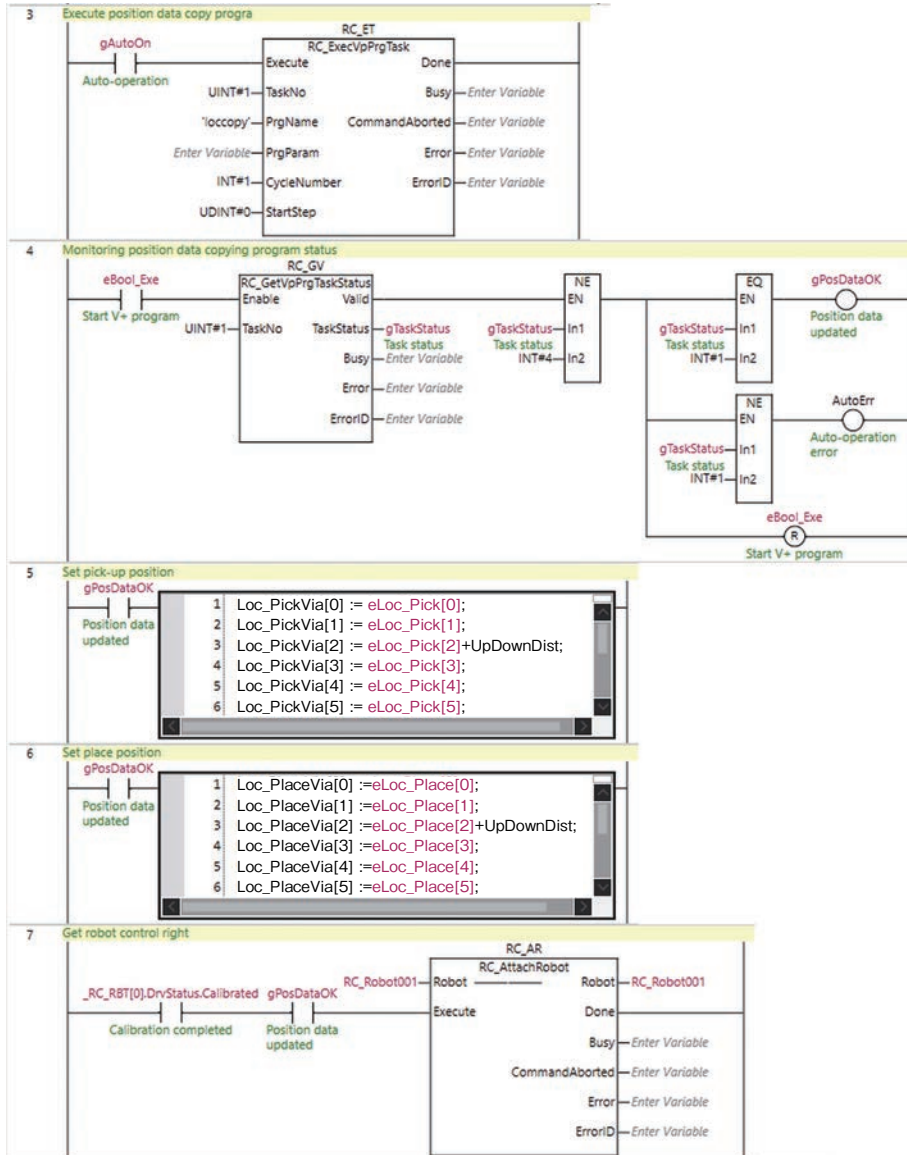

### 3 Implementation Example of Static Pick-and-place Equipment

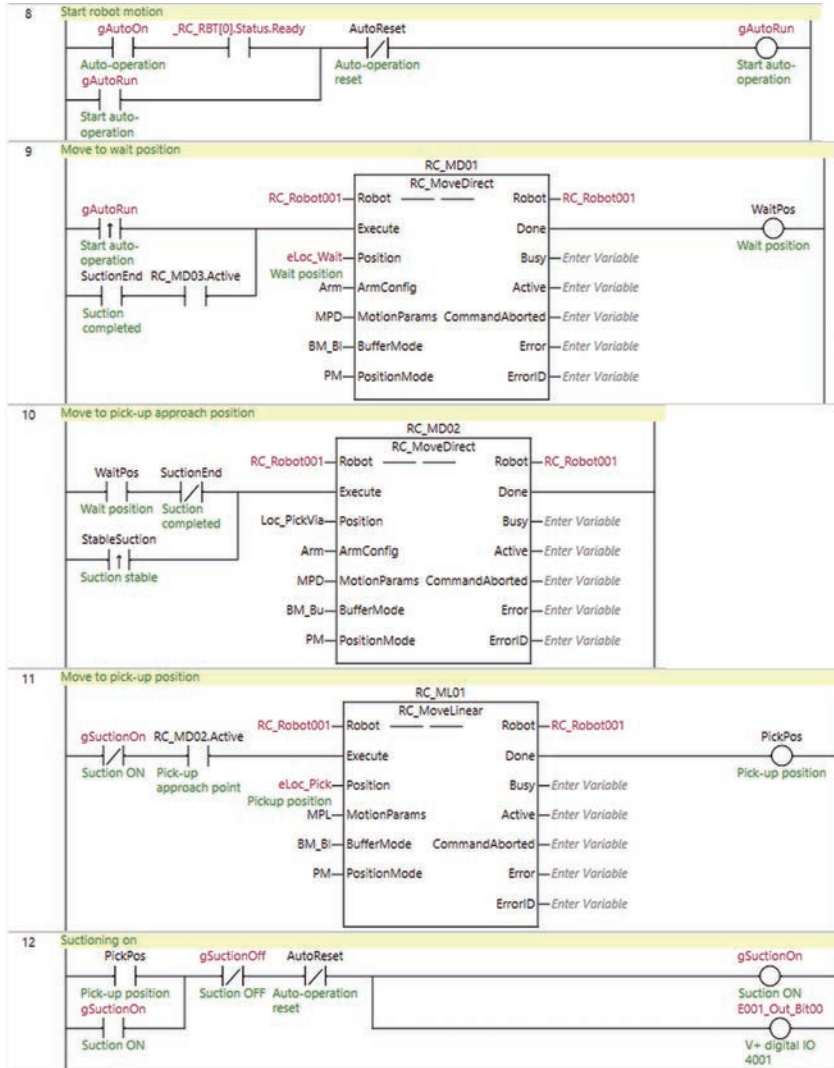

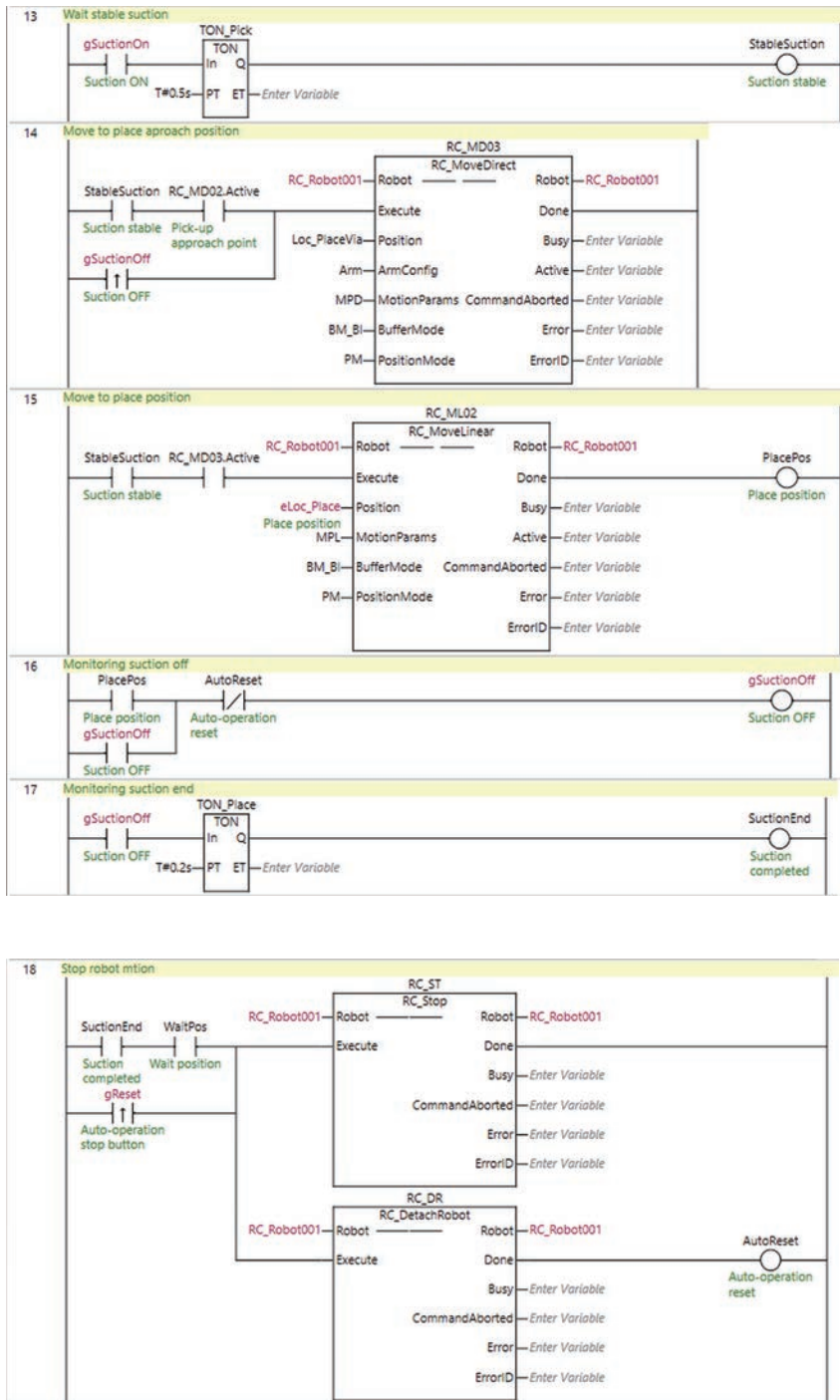

## V+ Program

The V+ program that is required for controlling operations of the static pick-and-place equipment in the sequence control program is described below.

The V+ program is used to register global variables and create two programs, "loccopy" (variable copy program) and "auto" (read program).

- **Global Variables**

Register the global variables that are used in the V+ program.

Name	Type	Value	Robot	Display Mod	Category	Description
gl.pick	Location	408.400 0.000 263.000 0.000 180.000 -150.000	R1Cobra600	Do not disp		
gl.place	Location	-274.918 498.787 261.936 0.000 180.000 -179.927	R1Cobra600	Do not disp		
gl.wait	Location	400.000 0.000 330.000 0.000 180.000 -150.000	R1Cobra600	Do not disp		

#### ● Variable Copy Program (loccopy)

"loccopy" (variable copy program) is used to copy the global variables in the V+ program to the shared variables with the sequence control program.

A program is described below.

```
.PROGRAM loccopy()
    GLOBAL gl.pick, gl.place, gl.wait
    EXTERNAL eloc_pick[]
    EXTERNAL eloc_place[]
    EXTERNAL eloc_wait[]
    EXTERNAL ebool_exe
    ; Copy location data to external variables
    DECOMPOSE eloc_pick[] = gl.pick
    DECOMPOSE eloc_place[] = gl.place
    DECOMPOSE eloc_wait[] = gl.wait
    ebool_exe = TRUE
.END
```

#### ● Read Program

"auto" (read program) is used to read the V+ program and global variables from the SD Memory Card to main memory.

Refer to 3-3-8 *Setting up Automatic Loading of V+ Programs and Variables at Power ON* on page 3-77 for information on "auto" (read program).

### 3-1-2 When Operations are Controlled with V+ Program

The program specifications when operations of static pick-and-place equipment are controlled with the V+ program are described below.

The program consists of the following programs.

Program name	Language	Description
Main	Sequence control program (Ladder diagram)	Main program
run	V+ program	Robot commands send program
supervisor	V+ program	Status monitoring program



#### Precautions for Correct Use

The V+ program continues to run even if the Robot Integrated CPU Unit goes into PROGRAM mode. The supervisor detects the Controller's PROGRAM mode and stops the robot motion and V+ programs.

## Shared Variables

The following table shows a list of shared variables that are used in the sequence control program.

No.	Variable name	Data type	Description
1	eBool_ExeT1	BOOL	Use the variable to check that the execution of V+ task 1 is started in the sequence control program.
2	eBool_ExeT2	BOOL	Use the variable to check that the execution of V+ task 2 is started in the sequence control program.
3	eBool_Mode	BOOL	Use the variable to check the operating mode in the Robot Integrated CPU Unit in the V+ program.
4	eBool_Reset	BOOL	Use the variable to check that the reset button is pressed during automatic operation in the V+ program.

## Sequence Control Program

This section describes the sequence control program required for controlling the operation of the static pick-and-place equipment with the V+ program.

The sequence control program is used to register global variables and create "Main", a main program that monitors the status of peripheral devices and determines whether the automatic operation can start.

### ● Global Variables

Register the global variables that are used in the sequence control program.

Name	Data Type	Initial Value	AT	Retain	Constant	Network Publish	Comment
E001_In_Bit00	BOOL			<input type="checkbox"/>	<input type="checkbox"/>	Do not publish	
E001_In_Bit01	BOOL		ECAT://node#1/Read input 1st word/In Bit01	<input type="checkbox"/>	<input type="checkbox"/>	Do not publish	
E001_In_Bit02	BOOL		ECAT://node#1/Read input 1st word/In Bit02	<input type="checkbox"/>	<input type="checkbox"/>	Do not publish	
E001_In_Bit03	BOOL		ECAT://node#1/Read input 1st word/In Bit03	<input type="checkbox"/>	<input type="checkbox"/>	Do not publish	
E001_In_Bit04	BOOL		ECAT://node#1/Read input 1st word/In Bit04	<input type="checkbox"/>	<input type="checkbox"/>	Do not publish	
E001_In_Bit05	BOOL		ECAT://node#1/Read input 1st word/In Bit05	<input type="checkbox"/>	<input type="checkbox"/>	Do not publish	
E001_In_Bit06	BOOL		ECAT://node#1/Read input 1st word/In Bit06	<input type="checkbox"/>	<input type="checkbox"/>	Do not publish	
E001_In_Bit07	BOOL		ECAT://node#1/Read input 1st word/In Bit07	<input type="checkbox"/>	<input type="checkbox"/>	Do not publish	
E001_In_Bit08	BOOL		ECAT://node#1/Read input 1st word/In Bit08	<input type="checkbox"/>	<input type="checkbox"/>	Do not publish	
E001_In_Bit09	BOOL		ECAT://node#1/Read input 1st word/In Bit09	<input type="checkbox"/>	<input type="checkbox"/>	Do not publish	
E001_In_Bit10	BOOL		ECAT://node#1/Read input 1st word/In Bit10	<input type="checkbox"/>	<input type="checkbox"/>	Do not publish	
E001_In_Bit11	BOOL		ECAT://node#1/Read input 1st word/In Bit11	<input type="checkbox"/>	<input type="checkbox"/>	Do not publish	
E001_In_Bit12	BOOL		ECAT://node#1/Read input 1st word/In Bit12	<input type="checkbox"/>	<input type="checkbox"/>	Do not publish	
E001_In_Bit13	BOOL		ECAT://node#1/Read input 1st word/In Bit13	<input type="checkbox"/>	<input type="checkbox"/>	Do not publish	
E001_In_Bit14	BOOL		ECAT://node#1/Read input 1st word/In Bit14	<input type="checkbox"/>	<input type="checkbox"/>	Do not publish	
E001_In_Bit15	BOOL		ECAT://node#1/Read input 1st word/In Bit15	<input type="checkbox"/>	<input type="checkbox"/>	Do not publish	
E001_Minor_Fault	BOOL		ECAT://node#1/Sysmac Error Status/Minor Fault	<input type="checkbox"/>	<input type="checkbox"/>	Do not publish	
E001_Observation	BOOL		ECAT://node#1/Sysmac Error Status/Observation	<input type="checkbox"/>	<input type="checkbox"/>	Do not publish	
E001_Out_Bit00	BOOL			<input type="checkbox"/>	<input type="checkbox"/>	Do not publish	
E001_Out_Bit01	BOOL		ECAT://node#1/Write output 1st word/Out Bit01	<input type="checkbox"/>	<input type="checkbox"/>	Do not publish	
E001_Out_Bit02	BOOL		ECAT://node#1/Write output 1st word/Out Bit02	<input type="checkbox"/>	<input type="checkbox"/>	Do not publish	
E001_Out_Bit03	BOOL		ECAT://node#1/Write output 1st word/Out Bit03	<input type="checkbox"/>	<input type="checkbox"/>	Do not publish	
E001_Out_Bit04	BOOL		ECAT://node#1/Write output 1st word/Out Bit04	<input type="checkbox"/>	<input type="checkbox"/>	Do not publish	
E001_Out_Bit05	BOOL		ECAT://node#1/Write output 1st word/Out Bit05	<input type="checkbox"/>	<input type="checkbox"/>	Do not publish	
E001_Out_Bit06	BOOL		ECAT://node#1/Write output 1st word/Out Bit06	<input type="checkbox"/>	<input type="checkbox"/>	Do not publish	
E001_Out_Bit07	BOOL		ECAT://node#1/Write output 1st word/Out Bit07	<input type="checkbox"/>	<input type="checkbox"/>	Do not publish	
E001_Out_Bit08	BOOL		ECAT://node#1/Write output 1st word/Out Bit08	<input type="checkbox"/>	<input type="checkbox"/>	Do not publish	
E001_Out_Bit09	BOOL		ECAT://node#1/Write output 1st word/Out Bit09	<input type="checkbox"/>	<input type="checkbox"/>	Do not publish	
E001_Out_Bit10	BOOL		ECAT://node#1/Write output 1st word/Out Bit10	<input type="checkbox"/>	<input type="checkbox"/>	Do not publish	
E001_Out_Bit11	BOOL		ECAT://node#1/Write output 1st word/Out Bit11	<input type="checkbox"/>	<input type="checkbox"/>	Do not publish	
E001_Out_Bit12	BOOL		ECAT://node#1/Write output 1st word/Out Bit12	<input type="checkbox"/>	<input type="checkbox"/>	Do not publish	
E001_Out_Bit13	BOOL		ECAT://node#1/Write output 1st word/Out Bit13	<input type="checkbox"/>	<input type="checkbox"/>	Do not publish	
E001_Out_Bit14	BOOL		ECAT://node#1/Write output 1st word/Out Bit14	<input type="checkbox"/>	<input type="checkbox"/>	Do not publish	
E001_Out_Bit15	BOOL		ECAT://node#1/Write output 1st word/Out Bit15	<input type="checkbox"/>	<input type="checkbox"/>	Do not publish	
E001_Read_input_1st_word	WORD		ECAT://node#1/Read input 1st word	<input type="checkbox"/>	<input type="checkbox"/>	Do not publish	
E001_Sysmac_Error_Status	BYTE		ECAT://node#1/Sysmac Error Status	<input type="checkbox"/>	<input type="checkbox"/>	Do not publish	
E001_Write_output_1st_word	WORD		ECAT://node#1/Write output 1st word	<input type="checkbox"/>	<input type="checkbox"/>	Do not publish	
eBool_ExecT1	BOOL			<input type="checkbox"/>	<input type="checkbox"/>	Do not publish	V+ task start 1
eBool_ExecT2	BOOL			<input type="checkbox"/>	<input type="checkbox"/>	Do not publish	V+ task start 2
eBool_Mode	BOOL			<input type="checkbox"/>	<input type="checkbox"/>	Do not publish	CPU operation mode
eBool_Reset	BOOL			<input type="checkbox"/>	<input type="checkbox"/>	Do not publish	Auto-operation reset
gAutoOn	BOOL			<input type="checkbox"/>	<input type="checkbox"/>	Do not publish	Auto-operation start
gEnableT1	BOOL			<input type="checkbox"/>	<input type="checkbox"/>	Do not publish	V+ task in execution 1
gRC_Err	BOOL			<input type="checkbox"/>	<input type="checkbox"/>	Do not publish	Robot error
gStart	BOOL		ECAT://node#1/Read input 1st word/In Bit00	<input type="checkbox"/>	<input type="checkbox"/>	Do not publish	Auto-operation start button
gSysOK	BOOL			<input type="checkbox"/>	<input type="checkbox"/>	Do not publish	Operation ready
gTS1	INT			<input type="checkbox"/>	<input type="checkbox"/>	Do not publish	Task status 1
gTS2	INT			<input type="checkbox"/>	<input type="checkbox"/>	Do not publish	Task status 2
gVpErrT2	BOOL			<input type="checkbox"/>	<input type="checkbox"/>	Do not publish	Auto-operation error
gVpFinT2	BOOL			<input type="checkbox"/>	<input type="checkbox"/>	Do not publish	Auto-operation completed
RC_Robot001	_sRC_RBT_REF		RC//_RC_RBT[0]	<input type="checkbox"/>	<input checked="" type="checkbox"/>	Do not publish	
RC_Robot001_IO	_sRC_RBT_IO_REF		RC//_RC_RBT_IO[0]	<input type="checkbox"/>	<input type="checkbox"/>	Do not publish	

#### ● Main Program

"Main" (main program) is used to monitor the following status of the robot and EtherCAT Digital I/O Terminal and determine whether the automatic operation can start. Refer to the manuals of each device for details on the variables.

No.	Variable name	Description
1	_EC_PDslavTbl[1]	Check that the communications of the EtherCAT Digital I/O Terminal are established.
2	_RC_RBT[0].DrvStatus.Run-Mode	Check that the communications between the Robot Integrated CPU Unit and the robot are established.
3	GetRCError	Check whether an error caused by the Robot Control Function Module exists.
4	_RC_RBT[0].DrvStatus.ESTOP	Check whether the robot is in ESTOP state.
5	_RC_RBT[0].DrvStatus.Manual	Check that the operating mode of the robot is Manual mode.
6	_RC_RBT[0].DrvStatus.Power-Enabled	Check that the robot high power is enabled.

A program is described below.

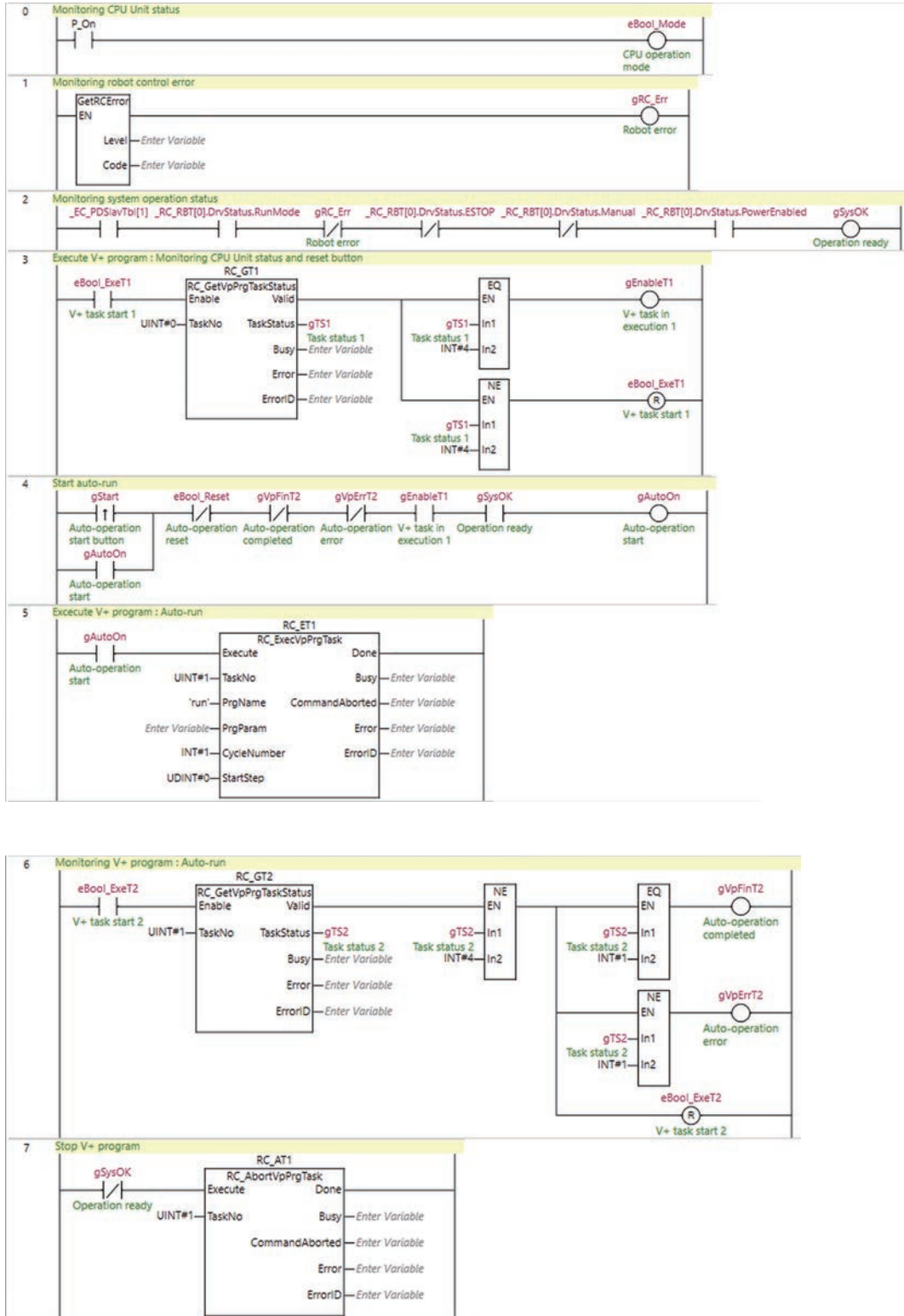

## V+ Program

This section describes the V+ program to control the static pick-and-place equipment. The V+ program is used to register global variables and create three programs, "run" (robot commands send program), "run.checkmode" (V+ program stop program), and "auto" (read program).

## ● Global Variables

Register the global variables that are used in the V+ program.

Name	Type	Value	Robot	Display Mod	Category	Description
gl.pick	Location	408.400 0.000 263.000 0.000 180.000 -150.000	R1Cobra600	Do not disp		
gl.place	Location	-274.918 498.787 261.936 0.000 180.000 -179.927	R1Cobra600	Do not disp		
gl.wait	Location	400.000 0.000 330.000 0.000 180.000 -150.000	R1Cobra600	Do not disp		

## ● Robot Commands Send Program

"run" (robot commands send program) is used to send robot commands to execute the static pick-and-place operations.

A program is described below.

```
.PROGRAM run()
; ABSTRACT: Pick and place program
    AUTO ar.speed, ar.accel, ar.wait_on, ar.wait_off, ar.dist, ar.loc[5], al.
safe
    EXTERNAL ebool_exet2
    ebool_exet2 = TRUE
; Set parameter
    ar.speed = 100 ; Speed ratio per full speed [%]
    ar.accel = 50 ; Accel ratio per full speed [%]
    ar.wait_on = 0.5 ; Wait time for air-on [sec]
    ar.wait_off = 0.2 ; Wait time for air-off [sec]
    ar.dist = 40 ; Approach and deppart distance [mm]
; Calculate and set temporary destination
    DECOMPOSE ar.loc[] = HERE
    SET al.safe = TRANS(ar.loc[0],ar.loc[1],DZ(gl.wait),ar.loc[3],ar.loc[4],a
r.loc[5])
;Prepare robot motion ready
    CALIBRATE
    ATTACH ()
    SPEED ar.speed, ar.speed ALWAYS
    ACCEL ar.accel, ar.accel
; Approach/Move to wait position
    MOVES al.safe
    MOVE gl.wait
    BREAK
; Approach/Move to pick position
    APPRO gl.pick, ar.dist
    MOVES gl.pick
    BREAK
;Suctioning on and waiting
    SIGNAL 4001
    WAIT.EVENT ar.wait_on
;Depart/Approach/MOVE to palce position
    DEPART ar.dist
    APPRO gl.place, ar.dist
```



```

        MOVES gl.place
        BREAK
; Suctioning off and waiting
        SIGNAL -4001
        WAIT.EVENT ar.wait_off
; Depart/Move to wait position
        DEPART ar.dist
        MOVE gl.wait
        BREAK
; Release robot control
        DETACH ()
.END

```

### ● Status Monitoring Program (supervisor)

The "supervisor" (V+ program stop program) detects the Robot Integrated CPU Unit going into PROGRAM mode and stops the robot motion and V+ programs by using the shared variables for the sequence control program and V+ programs.

A program is described below.

```

.PROGRAM supervisor()
; ABSTRACT: Stop pic and place program
        EXTERNAL ebool_mode
        EXTERNAL ebool_exet1, ebool_reset
        ebool_exet1 = TRUE
        WHILE TRUE DO
; Check NJ mode and reset-button
                IF (ebool_mode == FALSE) OR (ebool_reset == TRUE) THEN
; Abort current robot motion
                        BRAKE
; Terminate "run" program task
                                ABORT 1
; Wait until "run" program task has stopped
                                        CYCLE.END 1
; Clear a program execution stack
                                                KILL 1
                                                                END
                                                                IF (ebool_mode == TRUE) THEN
                                                                ebool_exet1 = TRUE
                                                                END
; Wait next robot control period
                                WAIT
                                                                END
                                                                .END

```

### ● Read Program

"auto" (read program) is used to read the V+ program and global variables from the SD Memory Card to main memory.

Refer to 3-3-8 *Setting up Automatic Loading of V+ Programs and Variables at Power ON* on page 3-77 for information on "auto" (read program).

## 3-2 Basic Startup Procedures

This section gives an overview of the basic startup procedures to build a static pick-and-place system. First, program a machine operation, configure and check the settings using the simulator, and then run the system for fine-tuning the operation.

No.	Procedure	Description	Reference
1	Programming and Simulation Procedures	Creating a project	Create a project file in the Sysmac Studio.
2		Creating the network configuration	Create the EtherCAT Network Configuration and add a robot on the network.
3		Writing the programs	Create a sequence control program and V+ programs.
4		Placing 3D shape data	Place 3D shape data and make the operating range of the robot visible on the 3D Visualizer.
5		Starting simulation	Activate the simulation function and start to simulate the robot motion.
6		Teaching (Simulation)	Use the simulation function of the Sysmac Studio for teaching the positions.
7		Running the program (Simulation)	Run the sequence control program on the simulator of the Sysmac Studio.
8	Installing and Wiring the System	Wiring the Robot Integrated CPU Unit and the EtherCAT Digital I/O Terminal	Wire the Robot Integrated CPU Unit and the EtherCAT Digital I/O Terminal.
9		Setting the node address of the EtherCAT Digital I/O Terminal	Set the EtherCAT node address of the EtherCAT Digital I/O Terminal.
10		Wiring the EtherCAT Digital I/O Terminal and the robot	Wire the EtherCAT Digital I/O Terminal and the robot.
11		Setting the EtherCAT node address of the robot	Set the EtherCAT node address of the robot.
12		Wiring the Robot Integrated CPU Unit and the computer	Wire the Robot Integrated CPU Unit and the computer.
13		Wiring the robot, T20 pendant and the front panel	Wire the robot and the T20 pendant, as well as the robot and the front panel.
14		Wiring the EtherCAT Digital I/O Terminal and the solenoid valve	Wire the EtherCAT Digital I/O Terminal and the solenoid valve.

No.	Procedure		Description	Reference
15	Setup Procedure for Actual System	Going online	Place the Sysmac Studio online with the Robot Integrated CPU Unit.	page 3-92
16		Transferring settings and programs	Download the programs and settings in the Sysmac Studio project file to the Robot Integrated CPU Unit.	page 3-94
17		Teaching (On the actual equipment)	Operate the robot to check and correct the teaching data.	page 3-96
18		Running the programs (On actual equipment)	Let the robot operate automatically according to the programs.	page 3-108

## 3-3 Programming and Simulation Procedures

This section describes the procedure for creating project files, programming, and setting and checking operation in simulation.

The simulation function allows you to check the equipment operation in advance without purchasing actual equipment.

### 3-3-1 Creating a Project File

Create a project in the Sysmac Studio.

- 1 Start the Sysmac Studio and click **New Project** in the Start page.

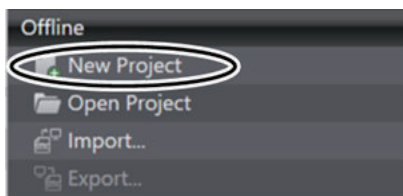

The **Project Properties** dialog box is displayed.

- 2 In the **Project Properties** dialog box, enter the **Project name**, **Author**, and **Comment**, and select the **Category**, **Device**, and **Version** as shown in the figure below.

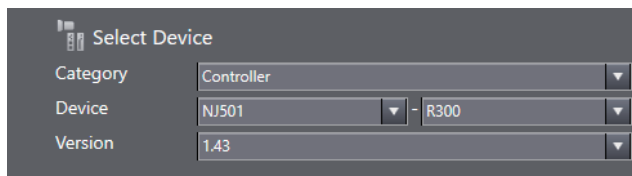

- 3 Select the **Open in Emulation Mode** check box, and click the **Create** button.

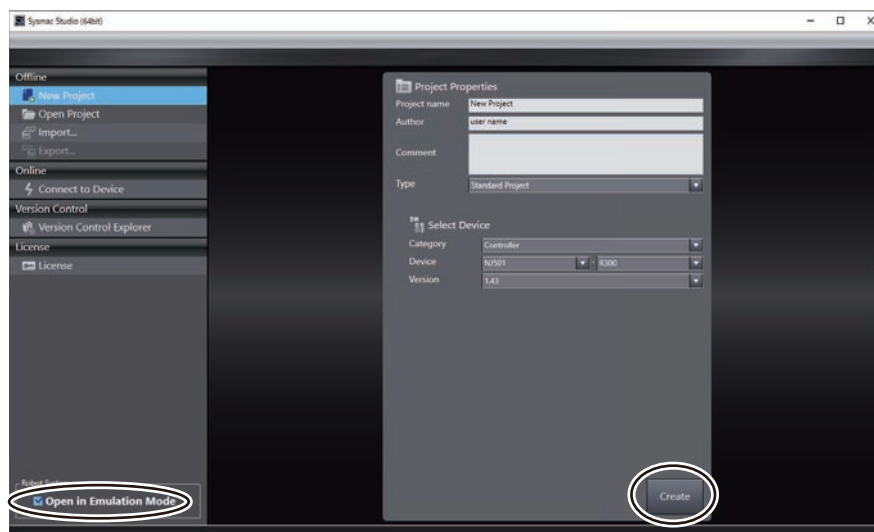

A project file is created and the following window is displayed.

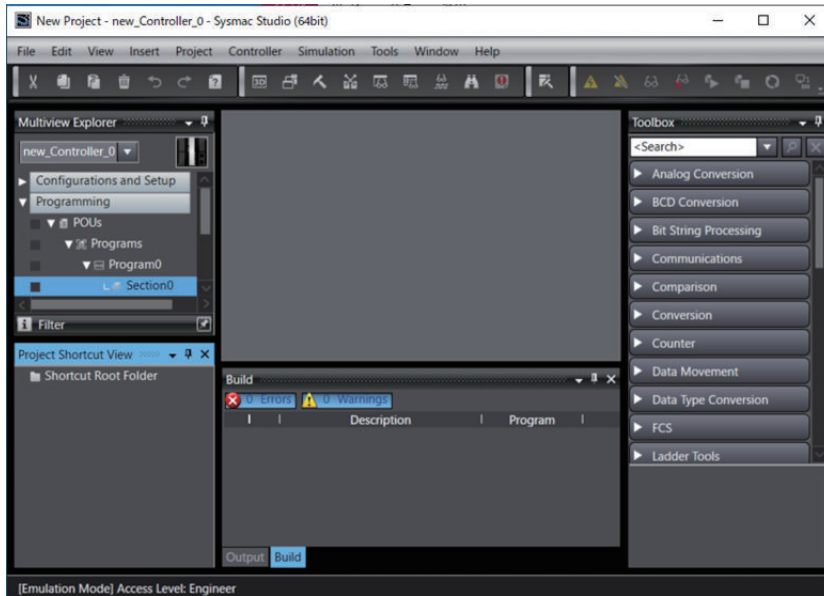

### 3-3-2 Creating the EtherCAT Network Configuration

Create the EtherCAT network configuration and add a robot on the network.

- 1 Click **Configurations and Setup** in the Multiview Explorer.

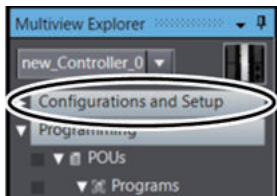

Setting items are displayed under **Configurations and Setup** in the tree.

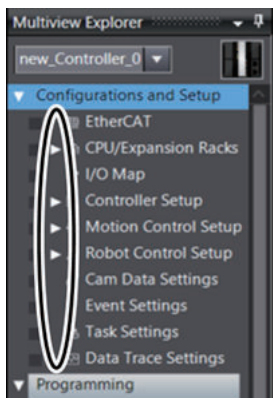

- 2 Double-click **EtherCAT** under **Configurations and Setup** in the Multiview Explorer. Or right-click **EtherCAT** under **Configurations and Setup** and select **Edit** from the menu.

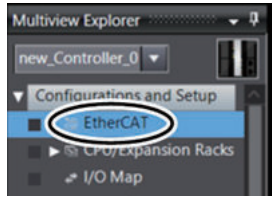

The EtherCAT Master is displayed in the EtherCAT tab page.

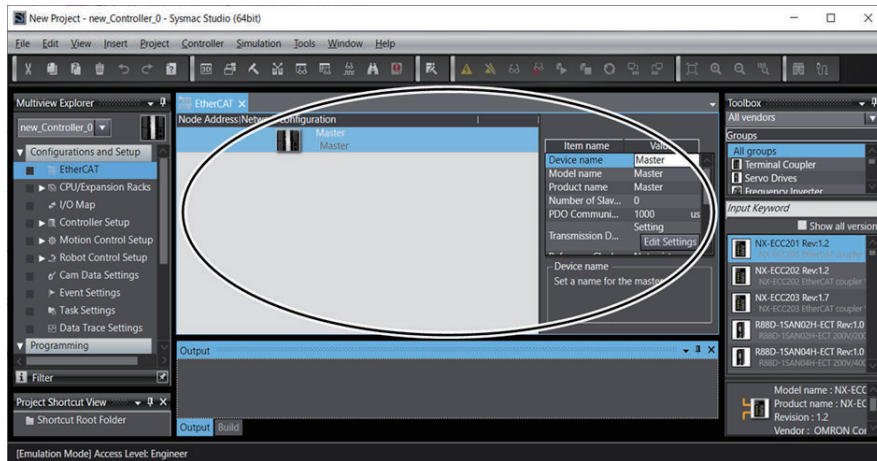

- 3 From the **Toolbox**, select the group of **Digital I/O**.

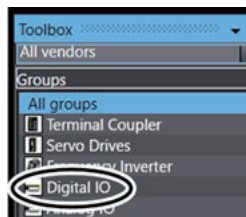

- 4 Click and drag the digital I/O to use and drop it on the EtherCAT Master in the EtherCAT tab page. In this example, select **GX-MD3218**.

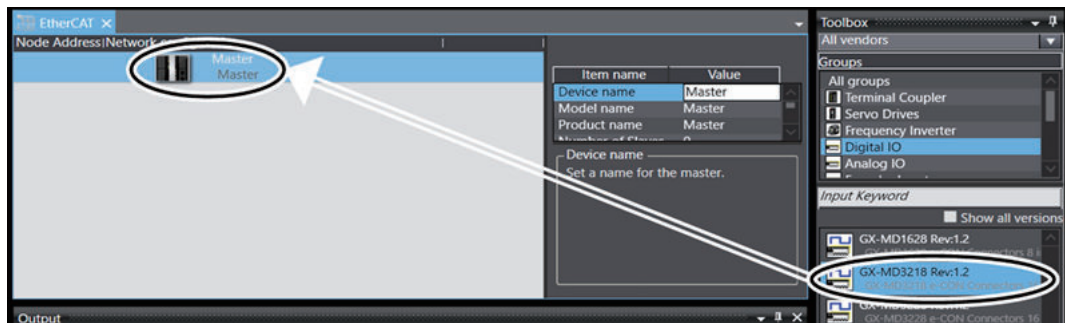

A **GX-MD3218** is registered under the EtherCAT Master.

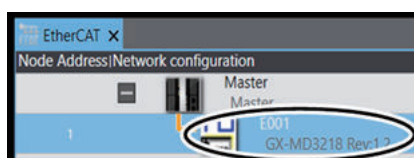

- 5 From the **Toolbox**, select the group of **Robot**.



- 6 Select and drag the robot to use and drop it on the **GX-MD3218** in the EtherCAT tab page. Here, select **eCobra 600 Pro**.

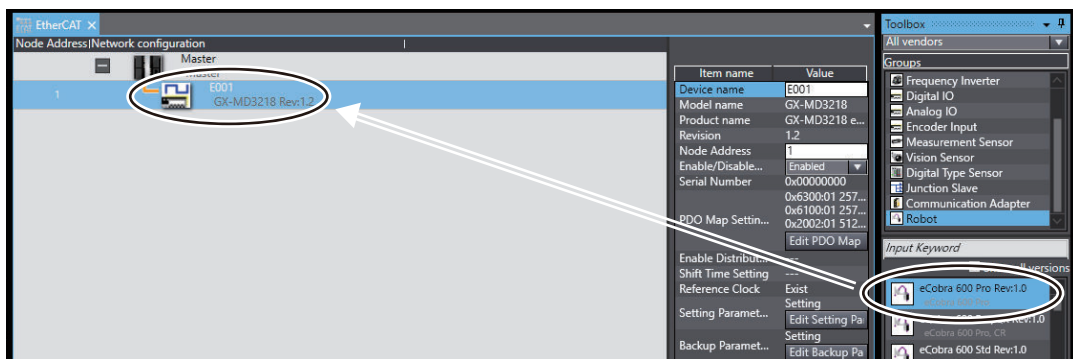

An **eCobra 600 Pro** is added under the **GX-MD3218**.

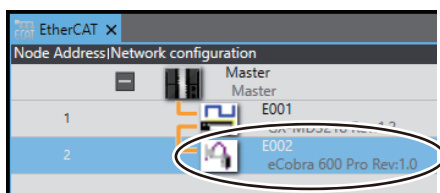

### 3-3-3 Creating a Sequence Control Program

This section provides the procedure for creating a sequence control program. For details on the program to create, refer to *3-1 Program Specifications for Static Pick-and-place Equipment* on page 3-2.

#### Creating Device Variables

Create device variables to control solenoid valves. You need to create device variables to use sequence control programs for controlling static pick-and-place operation. This setting is not required if you use V+ programs for controlling the operation.



- 1 Double-click **I/O Map** under **Configurations and Setup** in the Multiview Explorer.

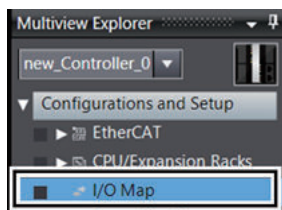

The **I/O Map** tab page is displayed.

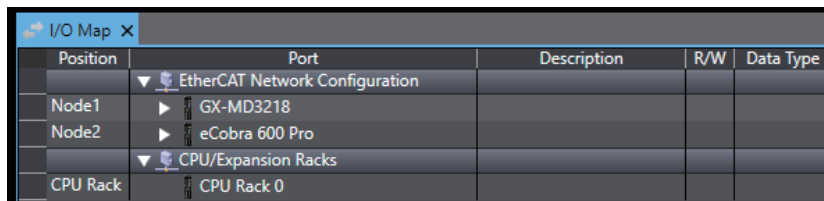

- 2 Tap the ▶ icon to the left of **GX-MD3218**.

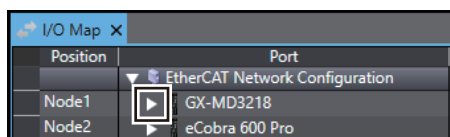

The I/O ports of the **GX-MD3218** are displayed.

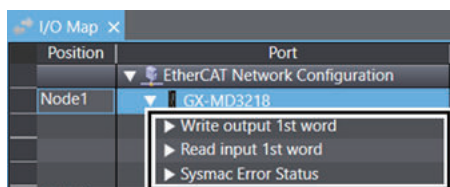

- 3 Right-click on the **GX-MD3218** and select **Create Device Variable** from the menu.

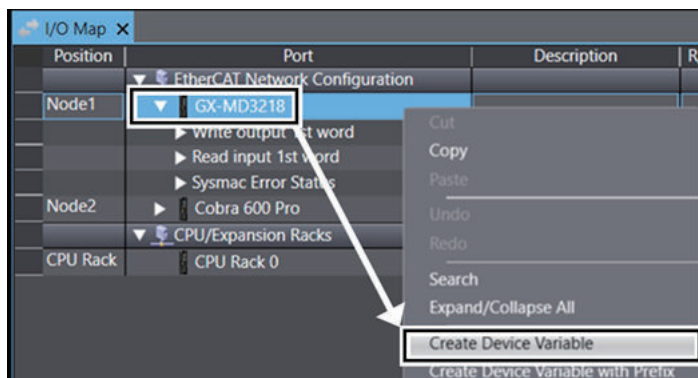

Device variables are automatically registered for the I/O ports of the **GX-MD3218**.

Position	Port	Description	R/W	Data Type	Variable
EtherCAT Network Configuration					
Node1	GX-MD3218				
	Write output 1st word	Digital output	W	WORD	E001_Write_output_1st_word
	Read input 1st word	Digital input va	R	WORD	E001_Read_input_1st_word
	Sysmac Error Status	Sysmac error st	R	BYTE	E001_Sysmac_Error_Status

## Defining Global Variables

Define global variables used as the position data in the sequence control program.

- 1 Double-click **Global Variables** under **Programming - Data** in the Multiview Explorer. Or, right-click **Global Variables** under **Programming - Data** and select **Edit** from the menu.

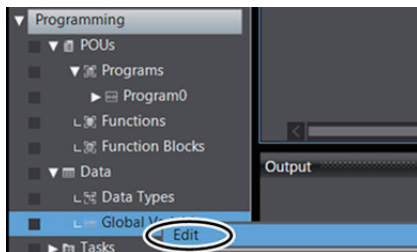

The global variable table is displayed.

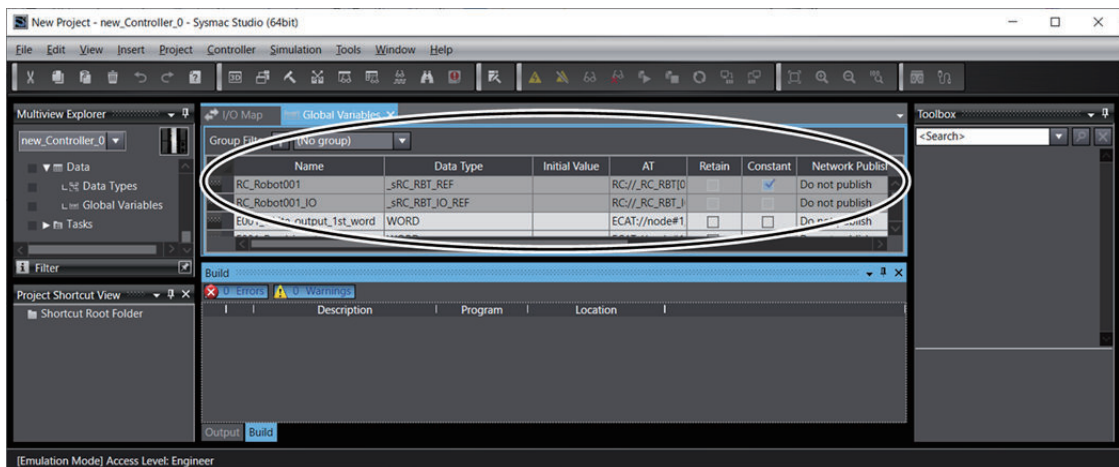

- 2 Press the **Insert** key in the global variable table, or right-click in the global variable table and select **Create New** from the menu.

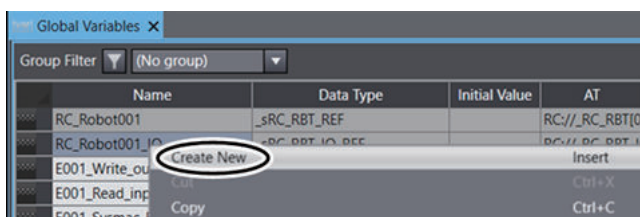

- 3 Enter or select setting for each item, and then press the **Enter** key.

Name	Data Type	Initial Value	AT	Retain	Constant	Network Publish
RC_Robot001	_sRC_RBT_REF		RC://_R	<input type="checkbox"/>	<input checked="" type="checkbox"/>	Do not publish
RC_Robot001_IO	eRC_RBT_IO_REF		RC://_R	<input type="checkbox"/>	<input type="checkbox"/>	Do not publish
eLoc Pick	ARRAY[0..5] OF LREAL			<input type="checkbox"/>	<input type="checkbox"/>	Do not publish

For information on global variables to register, refer to *Sequence Control Program* on page 3-3 if the system is controlled by the sequence control program or *Sequence Control Program* on page 3-11 when it is controlled by the V+ program.

The global variable is registered.

## Creating Ladder Diagram Programs

This section describes how to create the ladder diagram programs.

- 1 Right-click **Program0** under **Programming - POUs - Programs** in the Multiview Explorer and select **Rename** from the menu.

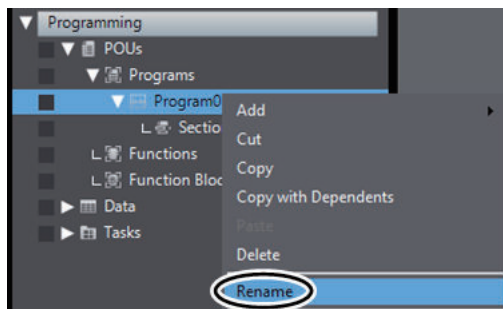

This allows you to edit the name of the sequence control program.

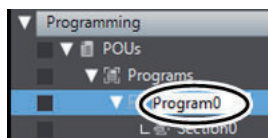

- 2 Enter the name of the sequence control program.  
The name of the sequence control program is changed.

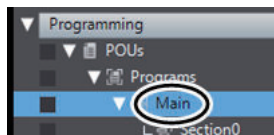

- 3 Double-click the section to edit.

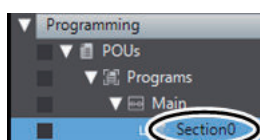

The variable table and Ladder Editor are displayed in the Edit Pane.

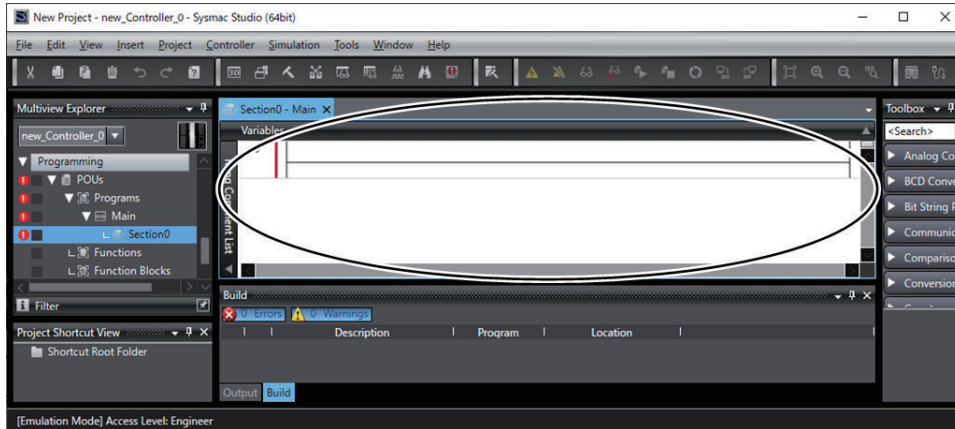

- 4 Enter the program in the Ladder Editor. Internal and external variables are automatically registered when they are entered in the program.  
For information on the programs, refer to *Sequence Control Program* on page 3-3 if the system is controlled by the sequence control program or *Sequence Control Program* on page 3-11 when it is controlled by the V+ program.

To create more than one sequence control program, perform the following steps.

- 5 Right-click **Programs** under **Programming - POUs** in the Multiview Explorer, and then select **Add - Ladder** from the menu.

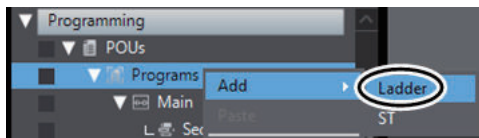

**Program0** is added under **Programs**.

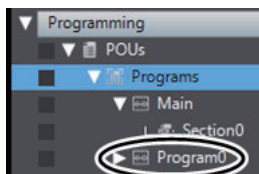

- 6 Click the icon displayed to the left of **Program0** under **Programming - POUs - Programs** in the Multiview Explorer.

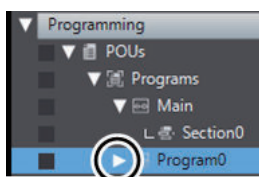

**Section0** is added under **Program0**.

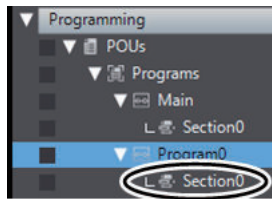

- 7 Returns to step 1 and repeat the above steps.

## Assigning Programs to Tasks

In this section, assign the ladder diagram programs to tasks of the Robot Integrated CPU Unit.

In this guide, multiple ladder diagram programs are used to control the static pick-and-place equipment, so it is necessary to assign the programs to tasks.

When the equipment is controlled by the V+ Program, only one ladder diagram program is used and you do not need to perform the steps in this section.

- 1 Double-click **Task Settings** under **Configurations and Setup** in the Multiview Explorer.

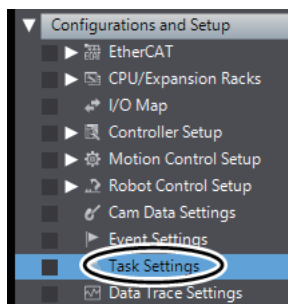

The **Task Settings** tab page is displayed.

- 2 Click the **Program Assignment Settings** button (  ) in the Edit Pane.

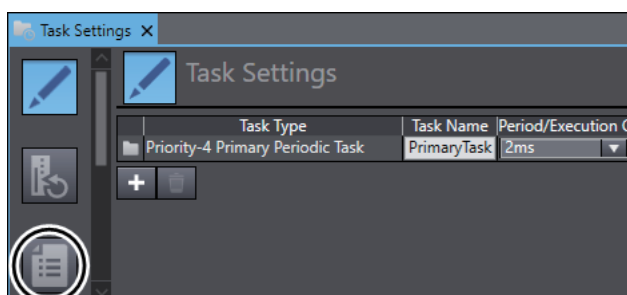

- 3 Click the + button.

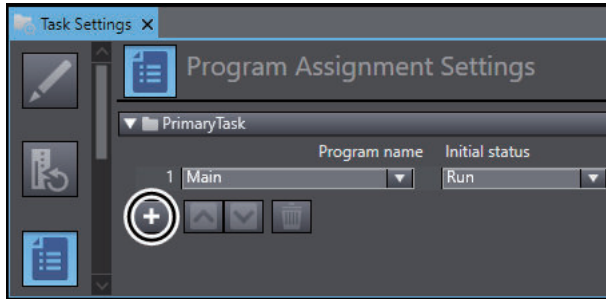

A new row is added for the program to assign.

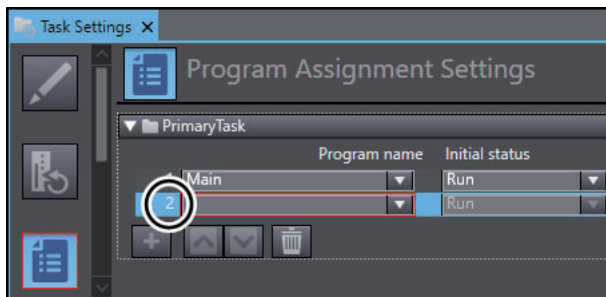

- 4 Select a name of the program to use from the list of the **Program name**.

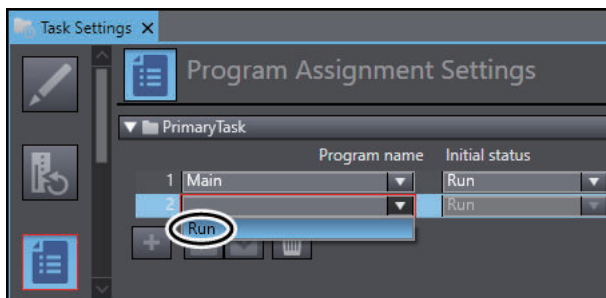

The name of the selected program is displayed.

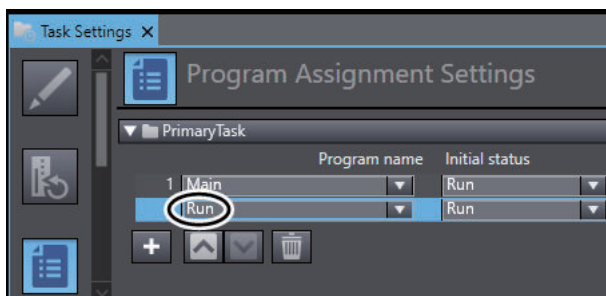

#### 3-3-4 Creating V+ Programs

This section provides the procedure for creating the V+ programs.

For details on the program to create, refer to *3-1 Program Specifications for Static Pick-and-place Equipment* on page 3-2.

## Setting V+Digital I/O

To control EtherCAT Slaves by V+ programs, you must assign V+ digital I/Os.

This setting is required to control the operation of the static pick-and- place equipment with the V+ program. If you use sequence control programs for controlling the operation, this setting is unnecessary.

- 1 In the Multiview Explorer, select **new\_Controller\_0** from the device list.

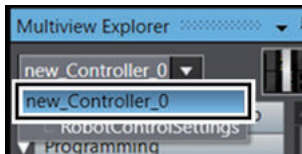

- 2 Click the  icon to the left of **Robot Control Setup** in the Multiview Explorer.

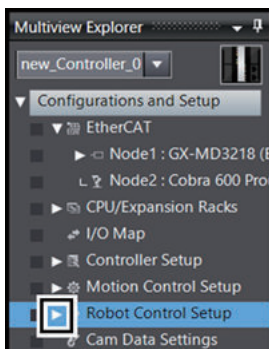

The setting items are displayed in the tree view as shown below.

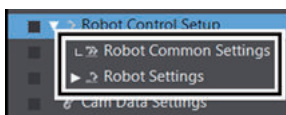

- 3 Double-click **Robot Common Settings**.

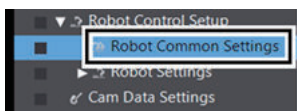

The **Robot Common Settings** tab page is displayed.

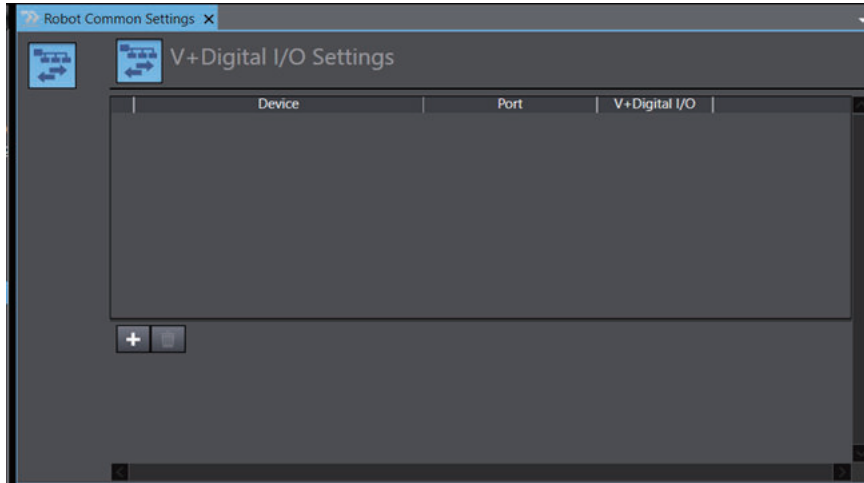

- 4** Click the **+** button in the **Robot Common Settings** tab page.

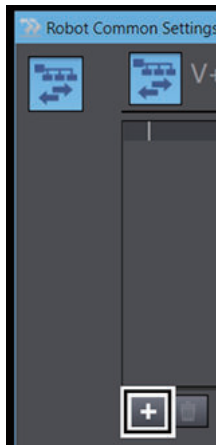

A row for registering a new V+ digital I/O is added.

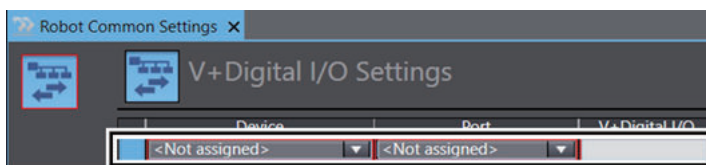

- 5** Click the drop-down list for **Device** in the newly added row, and then select **Node:1 GX-MD3218(E001)**.

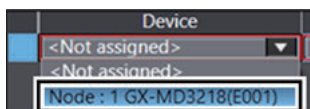

- 6** Click the drop-down list for **Port** in the same row, and select **Out Bit00**.





- 7** Enter **4001** for **V+Digital I/O**.

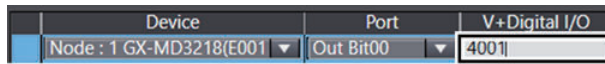

## Defining Global Variables

Define the global variables for use in the V+ program.

Here, the procedure to create a variable *gl.wait* is given below as an example, which is a global variable used in the V+ program in *3-1-1 When Operations are Controlled with Sequence Control Program* on page 3-3.

- 1** In the Multiview Explorer, select **RobotControlSettings** from the device list.

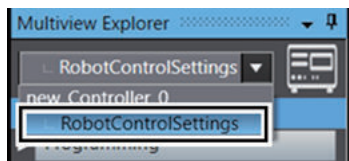

- 2** Double-click **Variables** under **Programming** in the Multiview Explorer.

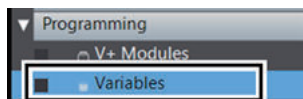

A tab page to edit variables is displayed in the Edit Pane so that you can register variables.

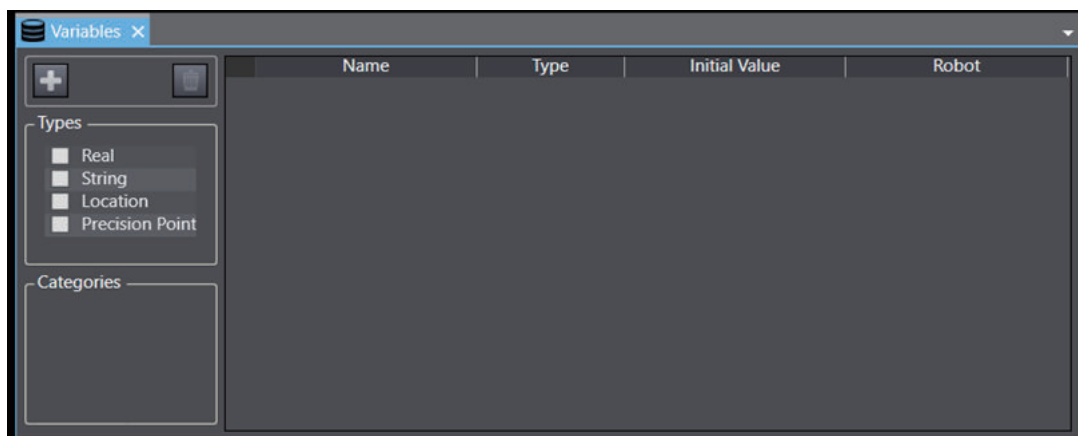

- 3** Click the **+** button.

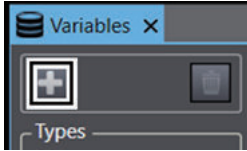

The **Add New Variable** table is displayed.

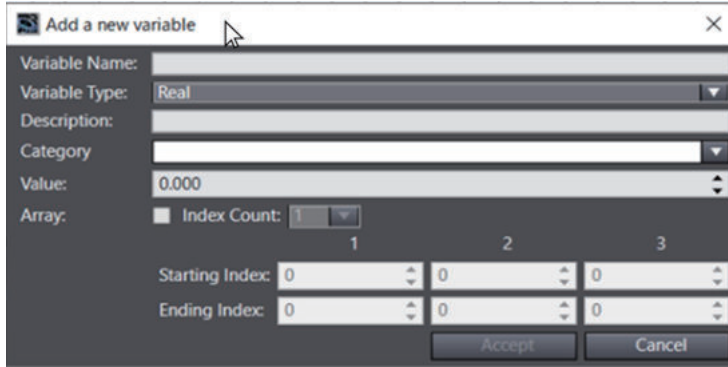

**4** Input a variable name.

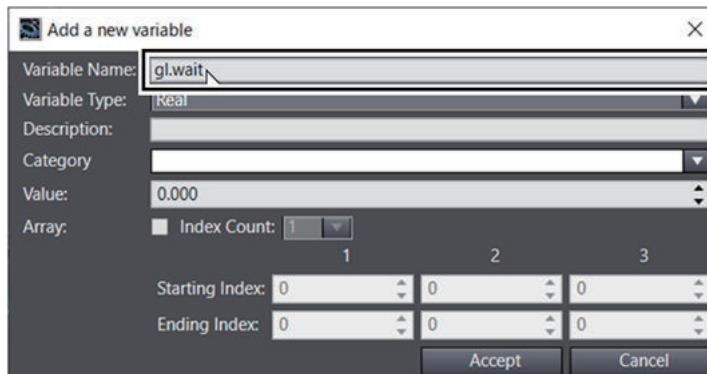

For information on global variables to register, refer to *V+ Program* on page 3-9 if the system is controlled by the sequence control program or *V+ Program* on page 3-13 when it is controlled by the V+ program.

**5** Select **Locations** from the list of variable types.

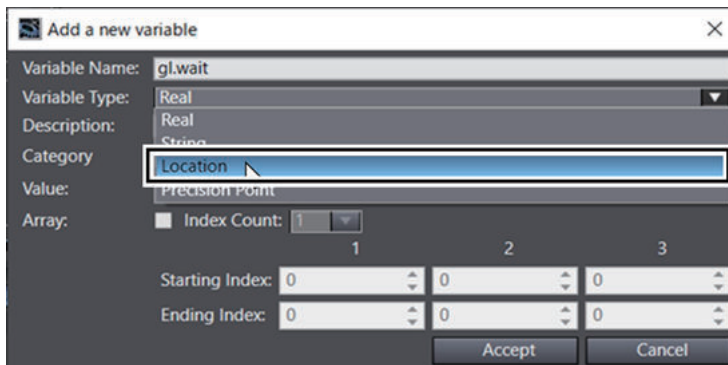

**6** Select **R1Cobra600** from the list for the robot.

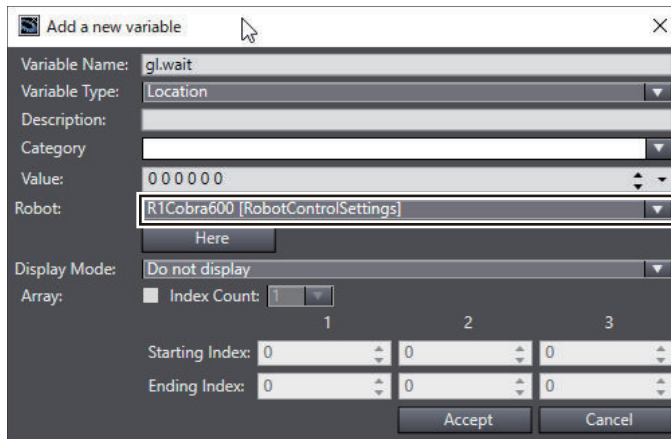

- 7 Click the **Accept** button.

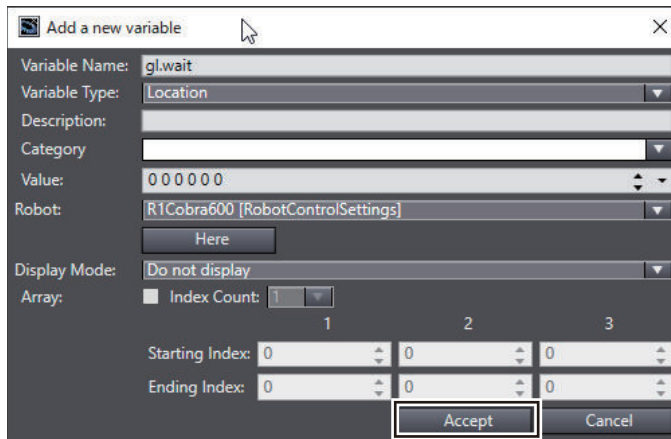

The variable **gl.wait** is added to the table.

Variable Name	Variable Type	Value	Robot	Display Mode
gl.wait	Location	584.953 0.100 379.410 0.000 180.000 180.000	R1Cobra600	Do not display

## Creating V+ Programs

This section describes the procedure to create V+ programs.

- 1 In the Multiview Explorer, select **RobotControlSettings** from the device list.

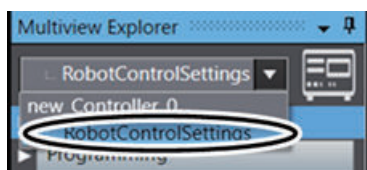

- 2 Right-click **V+ Modules** under **Programming** in the Multiview Explorer, and select **Add New Module** from the menu.

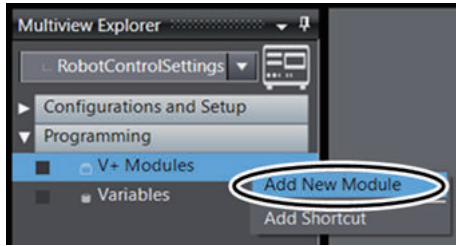

In the tree of the Multiview Explorer, **program0 - program0** are added under **V+ Modules**, which allows you to edit the name of the V+ program.

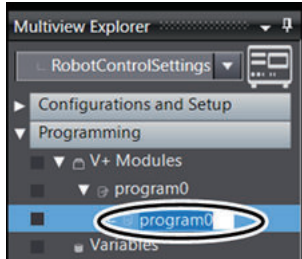

- 3** Enter the name of the V+ program.  
The name of the V+ program is changed.

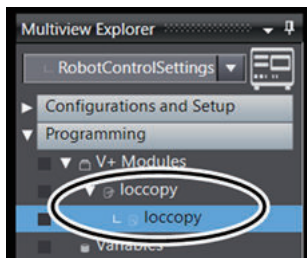

- 4** Double-click the program to edit.

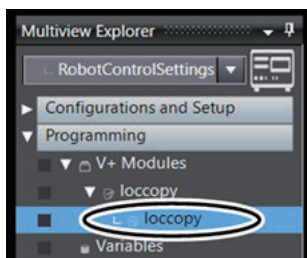

A tab page to edit the V+ program is displayed in the Edit Pane.

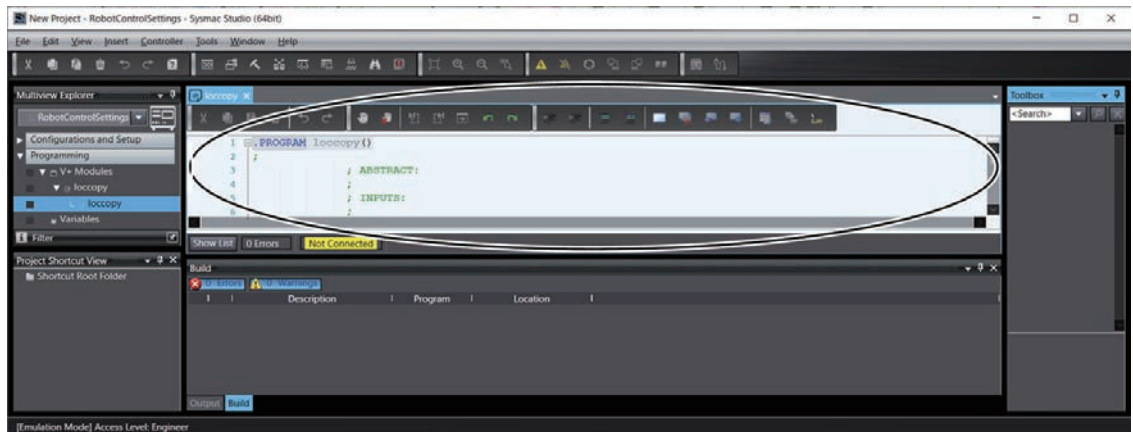

- 5 Create the program in the Edit Pane.  
For information on the programs, refer to *V+ Program* on page 3-9 if the system is controlled by the sequence control program or *V+ Program* on page 3-13 when it is controlled by the V+ program.

3

### 3-3-5 Placing 3D Shape Data

#### Making the Robot Motion Range Visible

You can make the operating range of the robot visible on the 3D Visualizer. Making the operating range visible makes it easier to set the position of the robot.

- 1 Select **3D Visualizer** from the **View** menu on the main window of the Sysmac Studio.

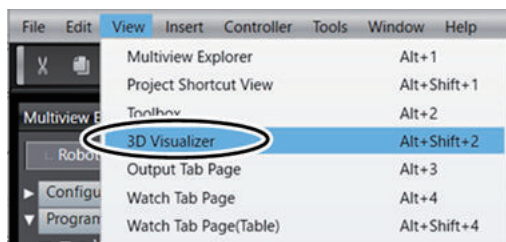

- 2 In the 3D Visualizer, click the Scene Graph icon.

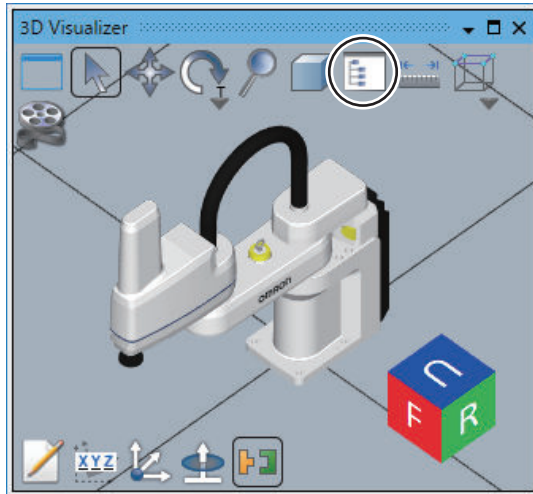

**Note** The 3D Visualizer is in Float mode state in this procedure. For information on Float mode, refer to *A-2-1 Set the 3D Visualizer to the Float Mode* on page A-21.

The **Scene Graph** dialog box is displayed.

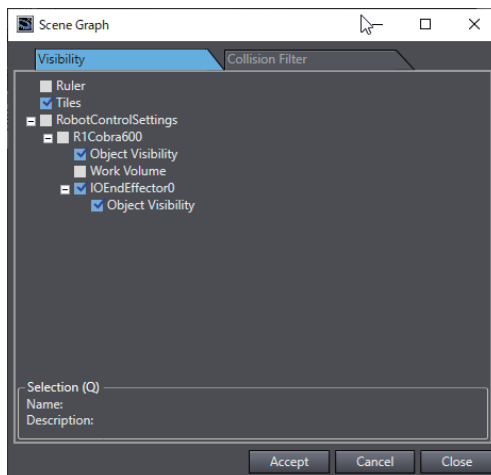

- 3** In the **Visibility** tab page, select the **Work Volume** check box located under **RobotControlSettings - R1Cobra600**.

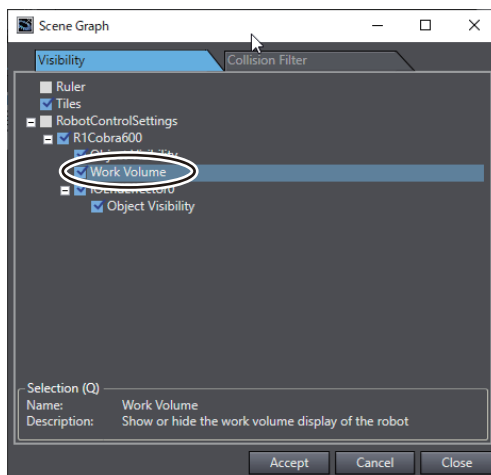

The 3D Visualizer illustrates the robot's operating range in gray.

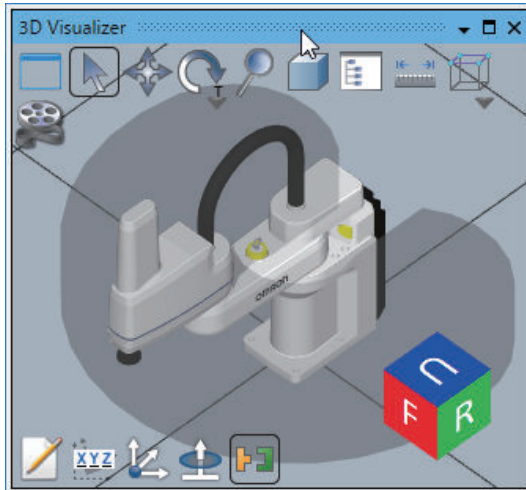

- 4 Click the **Close** button in the **Scene Graph** dialog box.

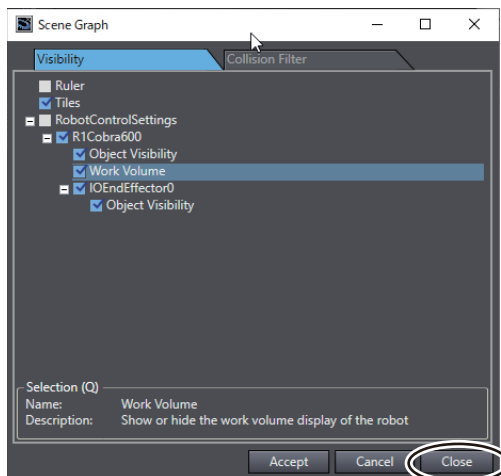

## Importing 3D CAD Data

Import the 3D CAD data of the conveyors as 3D shape data to the Sysmac Studio.

This section describes the procedure to import the 3D CAD data of Conveyor A and Conveyor B used in the equipment model in *1-4 Operations of Static Pick-and-place Equipment* on page 1-6.

- 1 Select **Application Manager** from the **Insert** menu on the main window of the Sysmac Studio.

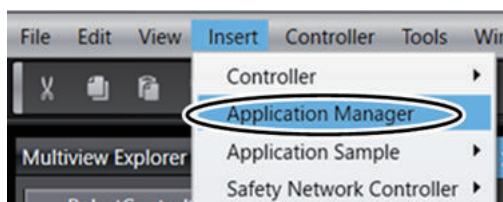

The **Add Device** dialog box is displayed.

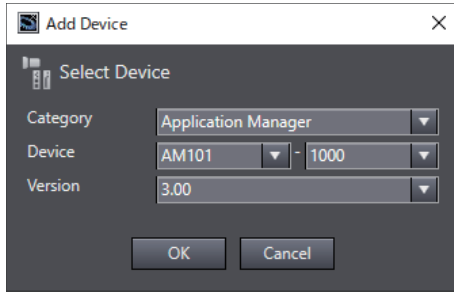

- 2** Select **Category**, **Device**, and **Version** as shown in the figure below, and then click the **OK** button.

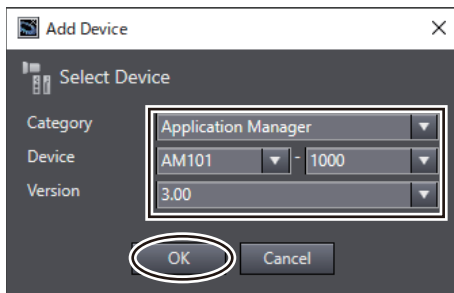

**ApplicationManager0** is added to the drop-down list at the top of the Multiview Explorer

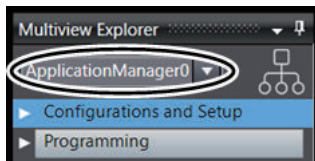

#### Additional Information

Application Manager added by this operation can only be used for simulation. Do not use it for actual device

- 3** Click **Configurations and Setup** in the Multiview Explorer.

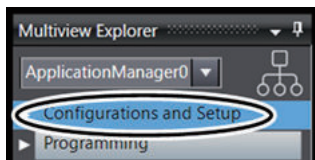

Setting items are displayed under **Configurations and Setup** in the tree.



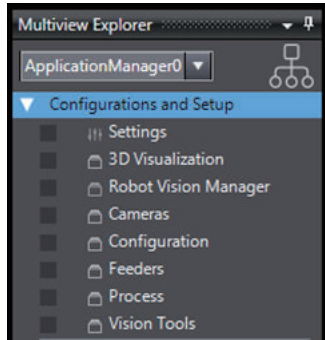

- 4** Right-click **3D Visualization**.  
The menu commands are displayed.

- 5** From the menu, select **Add - CAD Data**.

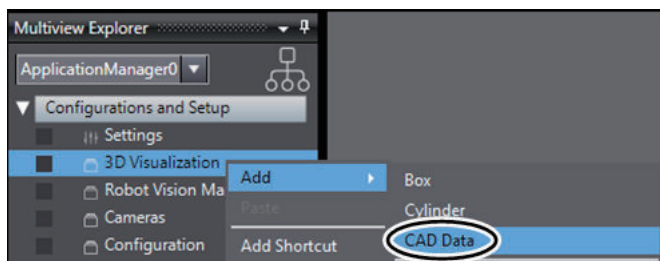

The **Import CAD File** wizard starts.



- 6** Select **Open my own CAD file**.
- 7** Click the **Next** button.

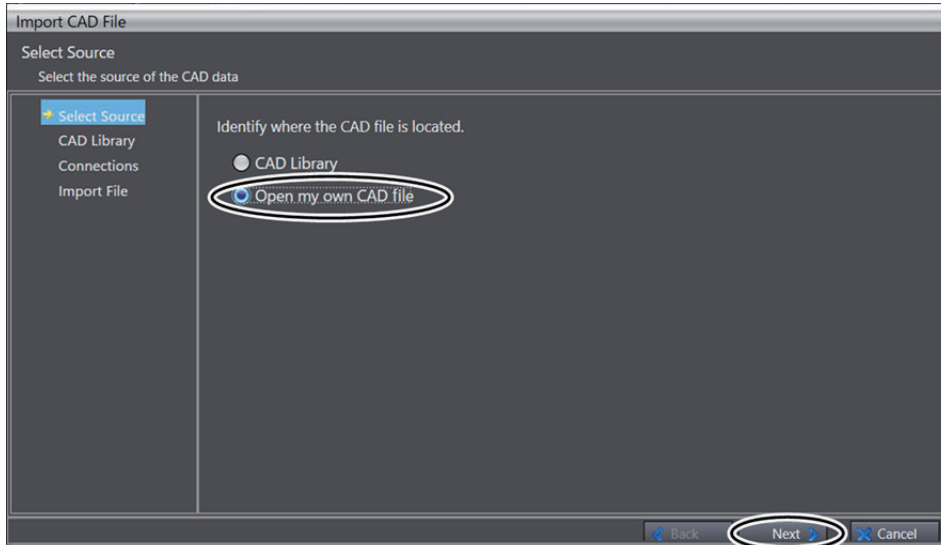

8 Click the **Open File** button.

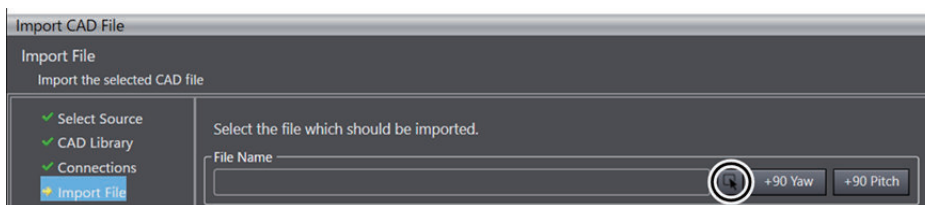

The **Open** dialog box is displayed.

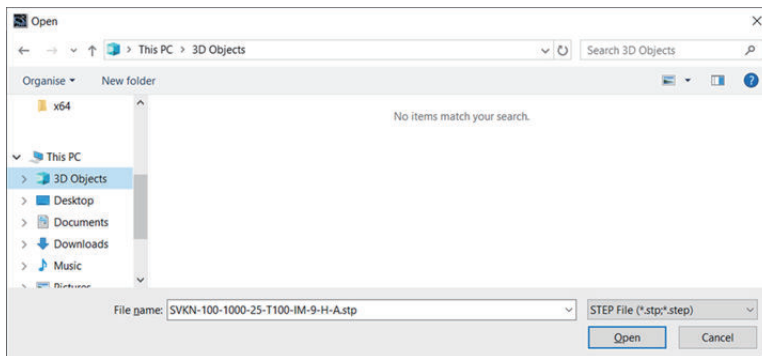

9 Select 3D CAD data to import, and then click the **Open** button.

In this example, you select the conveyor of MISUMI Corporation whose model number is SVKN-100-1000-25-T100-IM-9-H-A for the Conveyor A. You can import the 3D CAD data with the file name extension “stp”.

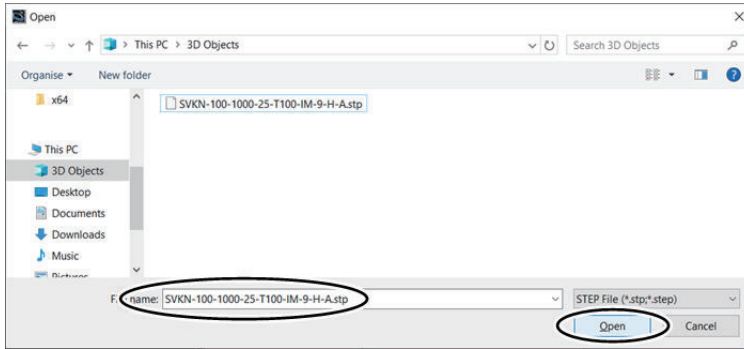

The **Open** dialog box is closed and import of 3D CAD data starts automatically.

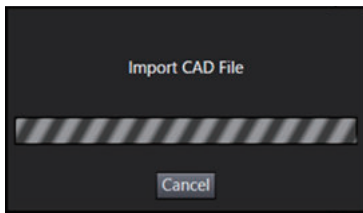

When the import completes, the assemblies of the import 3D CAD data is displayed in the **Import CAD File** wizard.

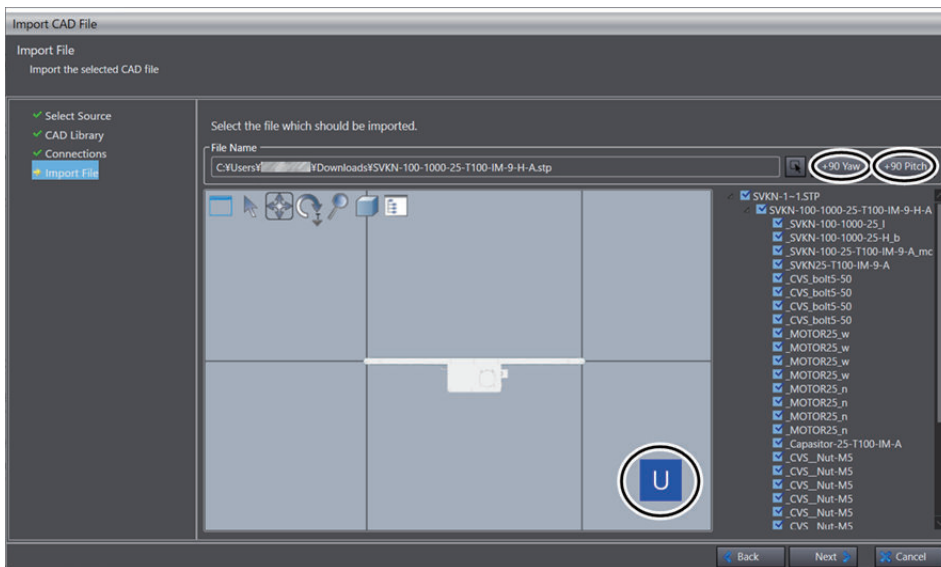

**Additional Information**

Align the conveyor top to the U face. Click the **+90 Yaw** button or **+90 Pitch** button to change the orientation of the conveyor.

If you use positioned and oriented CAD data, this operation is not necessary.

**10** Click the buttons in the following order; **+90 Yaw**, **+90 Pitch**, **+90 Yaw**, **+90 Pitch** and **+90 Pitch**

The conveyor top comes to the U face.



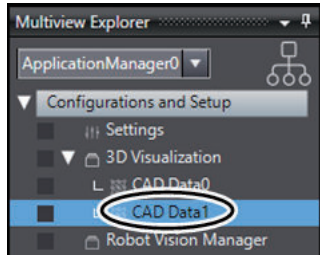

The 3D CAD Data for Conveyor A and Conveyor B are now imported.

## Placing 3D Shape Data on the 3D Visualizer

Place the imported 3D shape data in the appropriate position on the 3D Visualizer.

When 3D shape data is imported, the 3D shape data is positioned so that it has the same coordinate origin as the robot coordinate system. Therefore, it is necessary to move the 3D shape data to the appropriate position.

This section describes the procedure to place Conveyor A used in the equipment model in *1-4 Operations of Static Pick-and-place Equipment* on page 1-6 as an example.



### Additional Information

For information on setting up in the 3D Visualizer and translating the point of view in the 3D Visualizer, refer to the *A-2 How to Use 3D Visualizer* on page A-21.

- 1 Select **3D Visualizer** from the **View** menu on the main window of the Sysmac Studio.

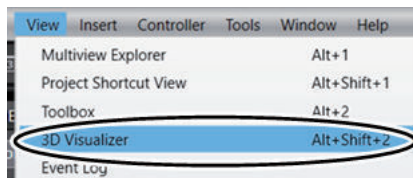

The 3D Visualizer is displayed on the right side of the main window.

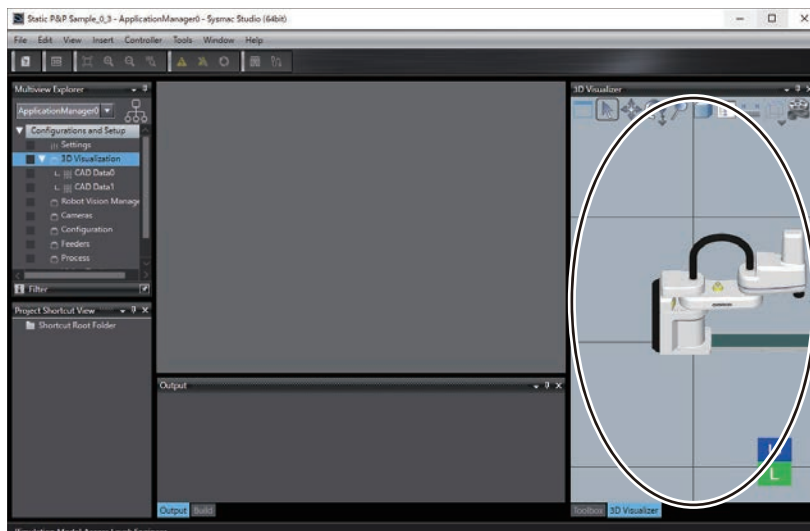

- 2 In the 3D Visualizer, select the imported 3D shape data with the mouse cursor and right-click it. The menu commands are displayed.



### Additional Information

When you move the mouse cursor on the 3D shape data in the 3D Visualizer, the name of the 3D shape data **/ApplicationManager0/CAD Data0** is displayed.

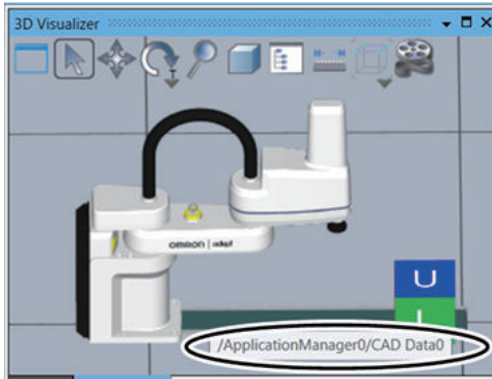

- 3 Select **Edit Workspace Position** from the menu.

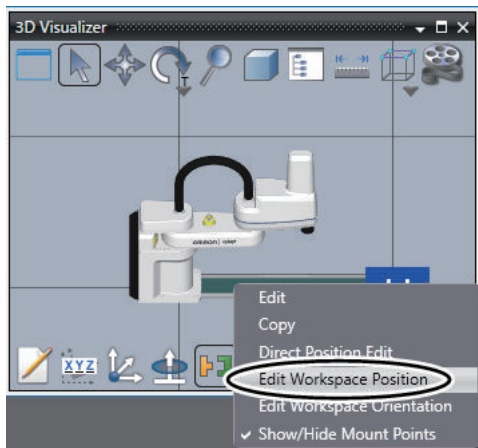

The Move icon consisting of colored arrows, a purple circle, and faces is displayed on the origin of the 3D shape data.

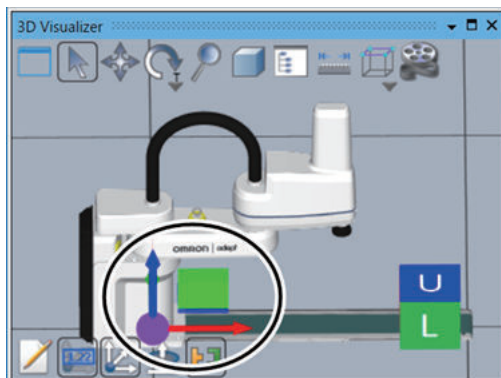

- 4 Drag one of the arrows, faces, or the purple circle and drop it on the place to move the 3D shape data.

The Move icon has red, green, and blue arrows, which represent the X-axis, Y-axis, and Z-axis, respectively. The red face shows the YZ plane, the green face shows the ZX plane, and the blue face shows the XY plane.

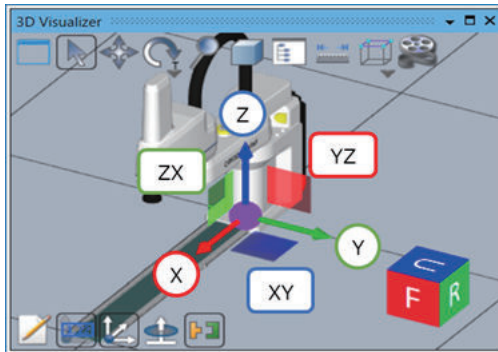

You can drag an arrow to move the 3D shape data along the axis. Or, use the face icon to move the 3D shape data on the corresponding plane. You can also move the 3D shape data independently from the axis direction by dragging the purple circle.

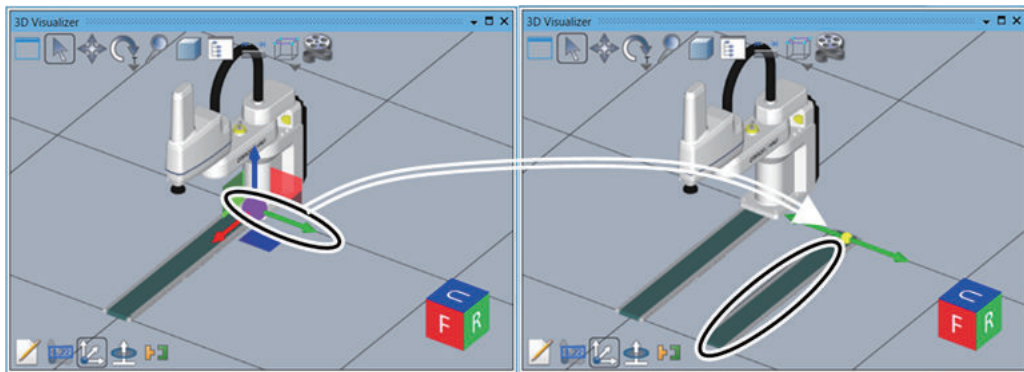

### Additional Information

When the Move icon is hidden, click the 3D shape data to display it.

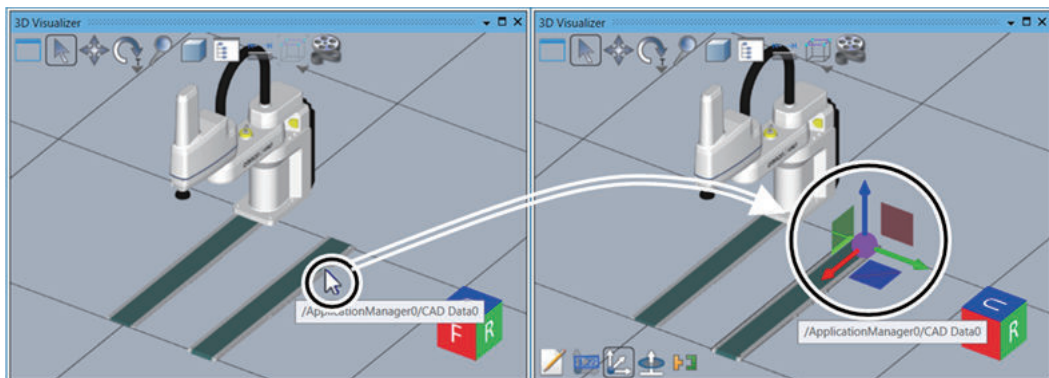

- 5 Right-click the 3D shape data you are moving in the 3D Visualizer. The menu commands are displayed.
- 6 Select **Edit Workspace Position** from the menu to clear the selection.

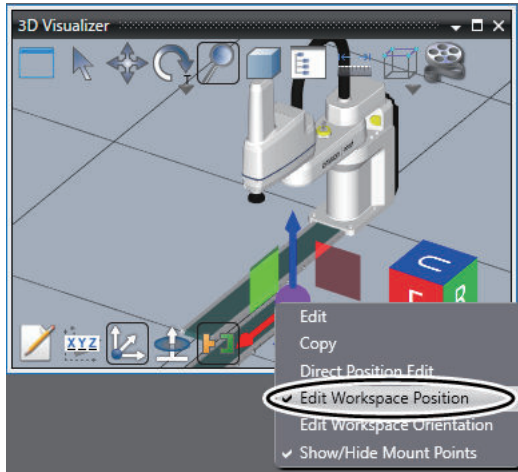

**7** Right-click the 3D shape data in the 3D Visualizer.  
The menu commands are displayed.

**8** Select **Edit Workspace Orientation** from the menu.

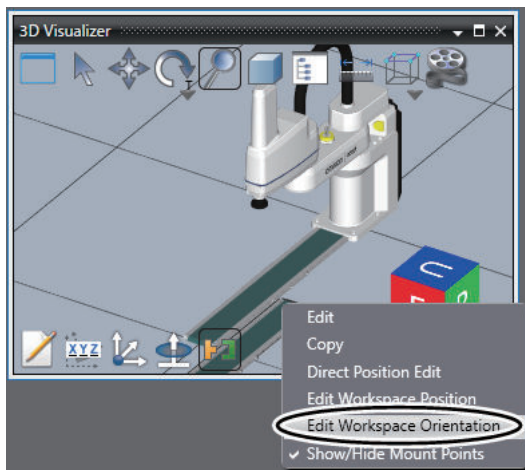

The Rotate icon is displayed on the 3D shape data.

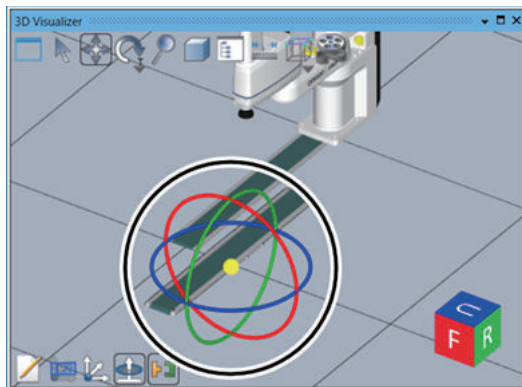

**9** Drag and drop the handle of the Rotate icon to rotate the 3D shape data around the axis to an appropriate orientation.  
The icon has red, green, and blue handles, which represent rotation around the X-axis, Y-axis, and Z-axis, respectively.



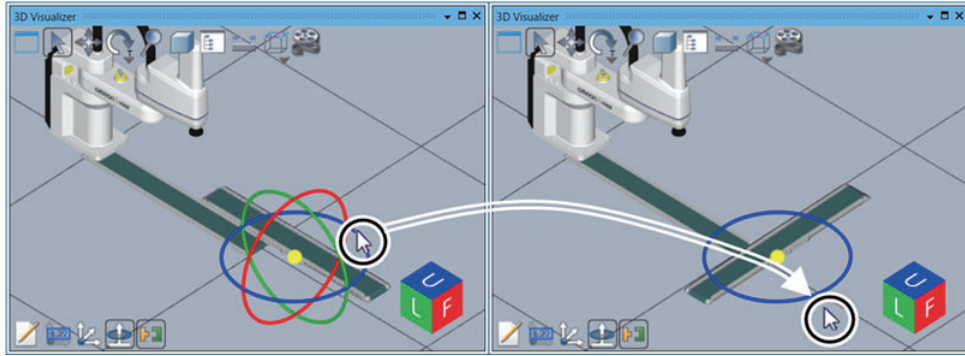

**10** Right-click the 3D shape data to adjust the orientation in the 3D Visualizer. The menu commands are displayed.

**11** Select **Edit Workspace Orientation** from the menu to clear the selection.

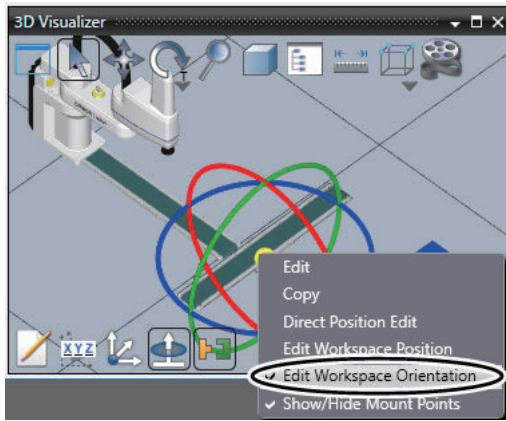

**12** Right-click the 3D shape data that you were adjusting the orientation in the 3D Visualizer. The menu commands are displayed.

**13** Select **Direct Position Edit** from the menu.

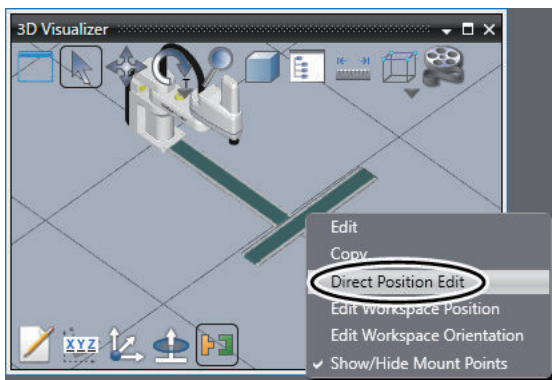

The input fields for editing the position of the 3D shape data is displayed.

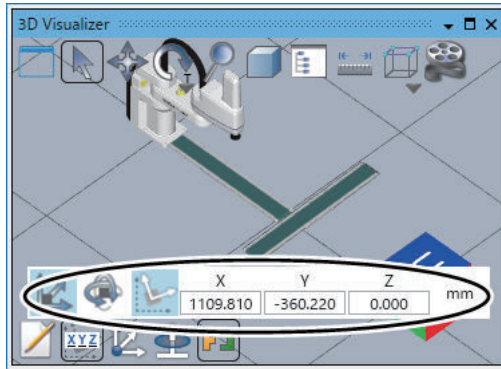

- 14** Enter values in mm in the X, Y, and Z fields to move the 3D shape data to an appropriate position.

The position of the 3D shape data changes according to the input values.

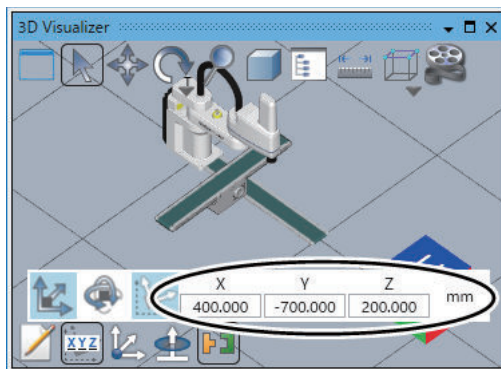

- 15** Click the **Edit Workspace Orientation** icon.

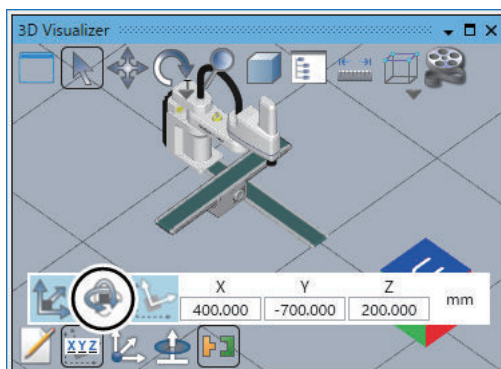

The input fields for editing the orientation of the 3D shape data is displayed.

- 16** Enter values in degree in the input fields for Yaw, Pitch, and Roll to adjust the orientation of the 3D shape data.

The orientation of the 3D shape data changes according to the input values.

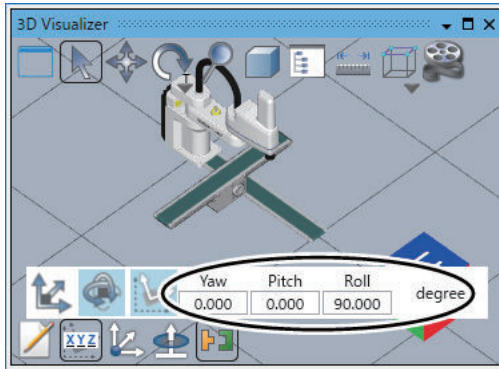

**17** In the 3D Visualizer, right-click the 3D shape data that you adjusted the position and orientation.

The menu commands are displayed.

**18** Select **Direct Position Edit** from the menu to clear the selection.

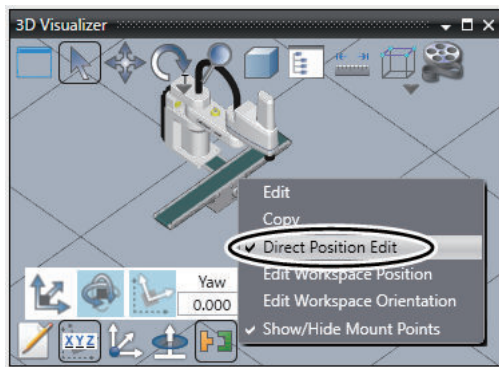

#### Precautions for Correct Use

Refer to the *Sysmac Studio 3D Simulation Function Operation Manual (Cat. No. W618)* for details on coordinate system in the 3D Visualizer.

**19** Perform step 2 and later to adjust the position and orientation of the CAD Data1 of Conveyor B.

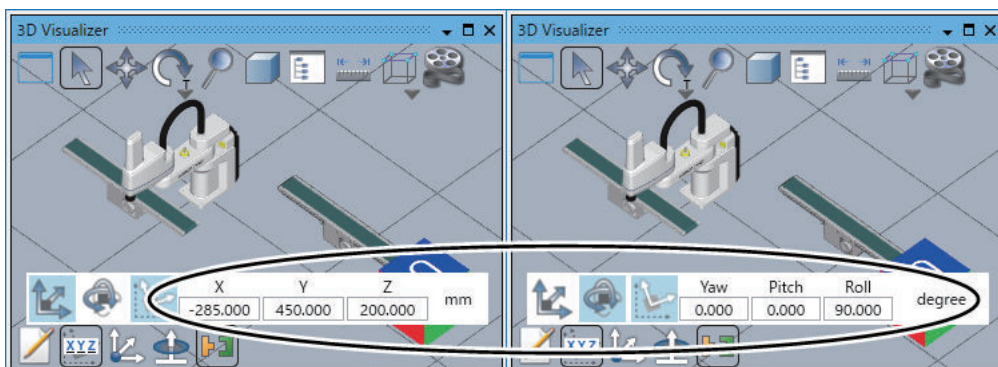

The 3D shape data of Conveyor A and Conveyor B are now placed in the appropriate positions in the 3D Visualizer.

## Setting the 3D Information of the Robot's End-effector

Set the 3D information of the Robot's end-effector.

- 1 Select **RobotControlSettings** from the device list in the Multiview Explorer.

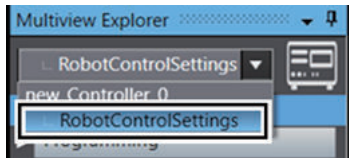

- 2 Click **Configurations and Setup** in the Multiview Explorer.

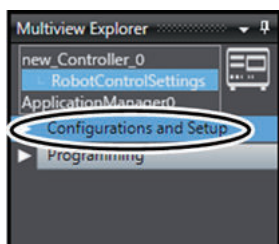

Setting items are displayed under **Configurations and Setup** in the tree.

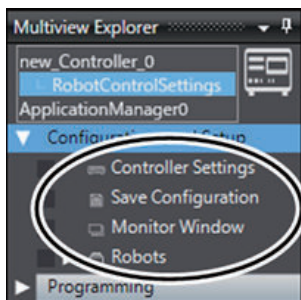

- 3 Double-click **Robots**.

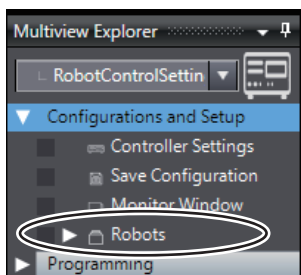

Setting items are displayed under **Robots** in the tree.

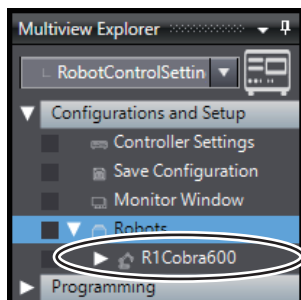

- 4 Click the  icon to the left of **R1Cobra600**.

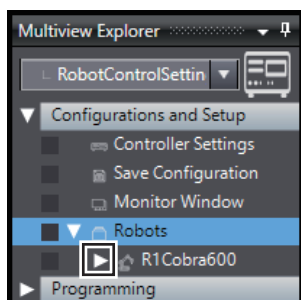

Setting items are displayed under **R1Cobra600** in the tree.

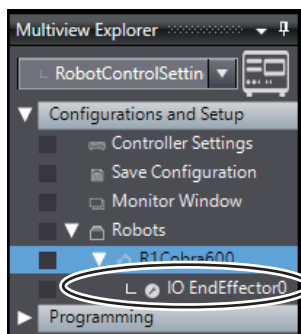

- 5 Double-click **IO EndEffector0**.

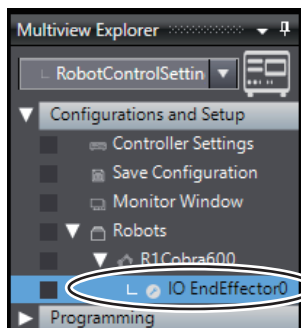

The **IO EndEffector0** dialog box is displayed.

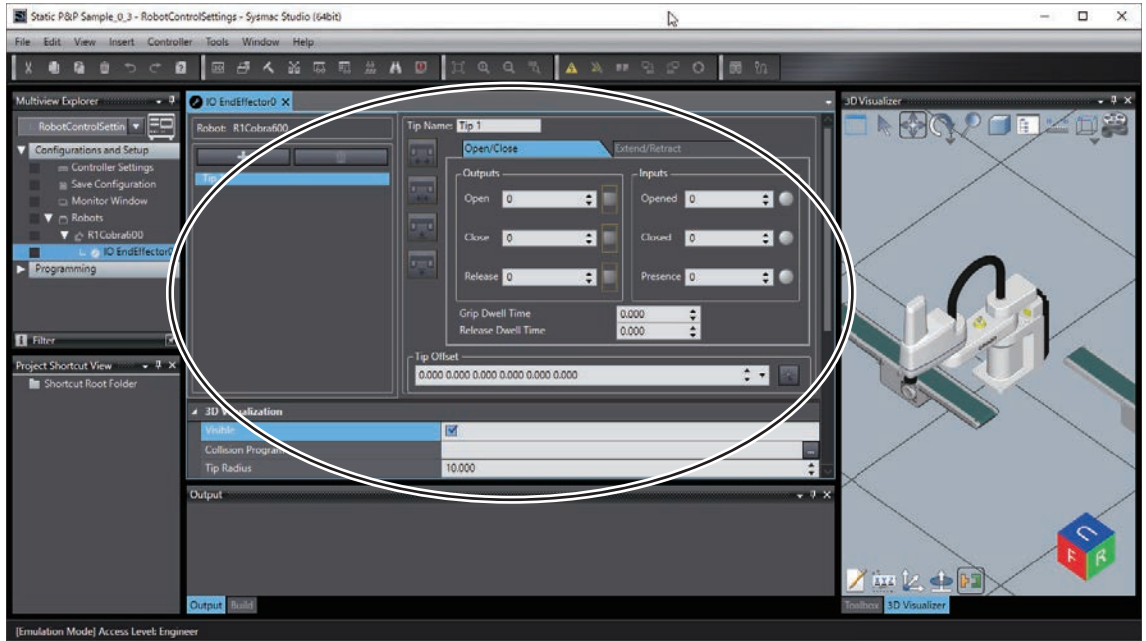

- 6** Set the length of the tool in the Z direction of the **Tip Offset**.  
In this example, enter the value as an example that the tool length is 50mm.  
Set **Tip Radius**, as required.

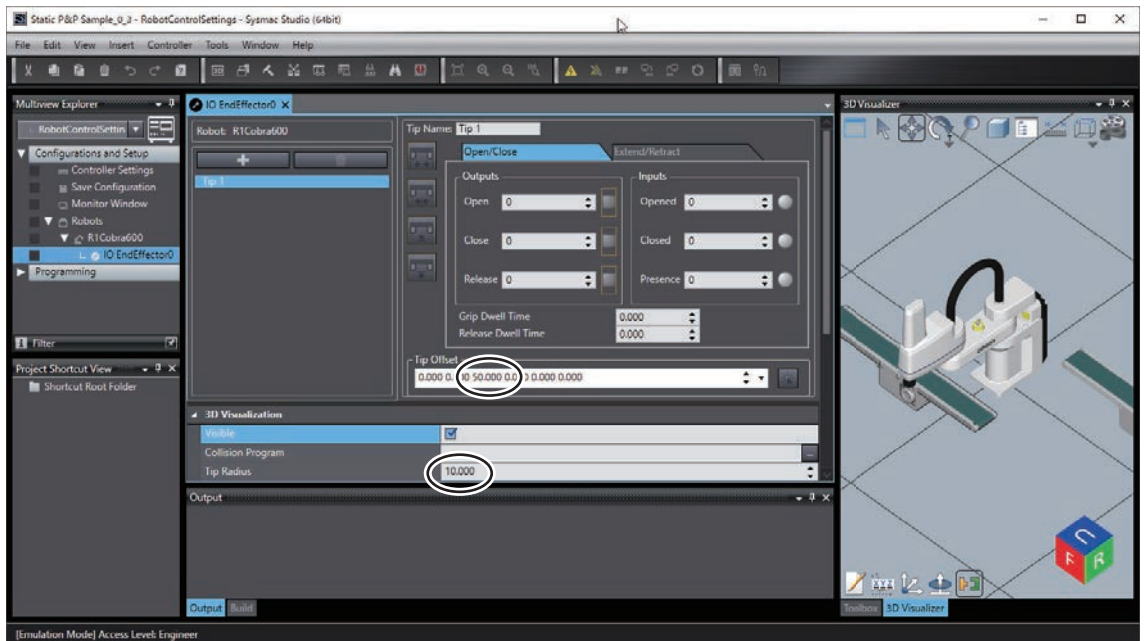

The end-effector of the set size is displayed on the 3D Visualizer.

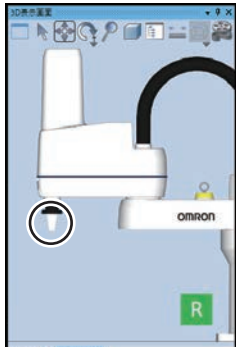

## Activating Collision Detection Function

The collision detection function detects the contacts in simulation that may occur between the robot and other 3D shape data, such as objects imported as 3D CAD data. If the robot may contact with other 3D shape data, you need to change the layout of the robot or the 3D shape data, or modify the movement of the robot.

In this section, the setting procedure to detect a contact between the robot, Conveyor A and Conveyor B is given. Because the collision detection function checks whether 3D shape data may conflict between groups, you create two groups; Group 0, which includes the robot, and Group 1, which includes Conveyor A and Conveyor B.



### Precautions for Correct Use

In this guide, the target of collision detection is the robot. When the 3D shape data is placed at the tool center point, collision detection of that 3D shape data is also required. For the operation procedure for the 3D shape data placed at the tool center point, refer to the *Sysmac Studio 3D Simulation Function Operation Manual (Cat. No. W618)*.

- 1 Select **3D Visualizer** from the **View** menu on the main window of the Sysmac Studio.

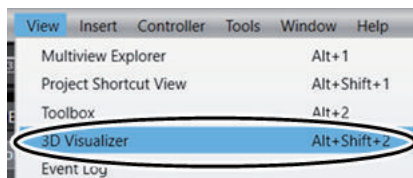

The 3D Visualizer is displayed on the right side of the main window.

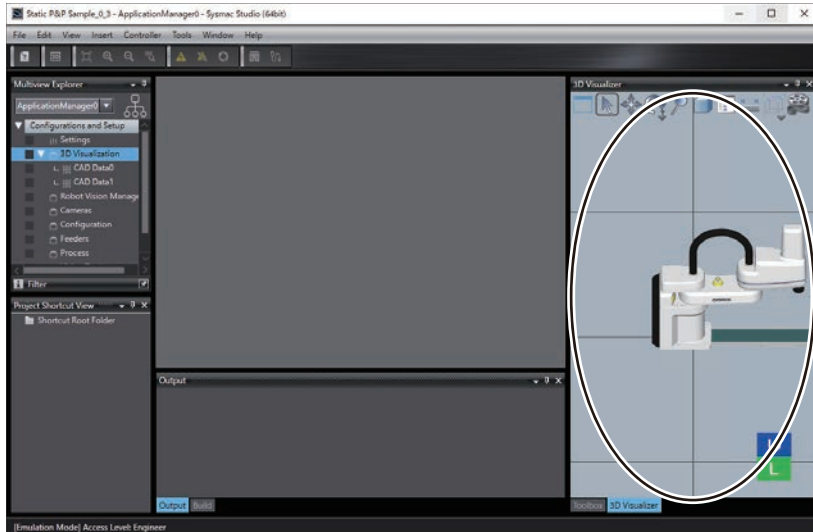

2 In the 3D Visualizer, click the **Scene Graph** icon.

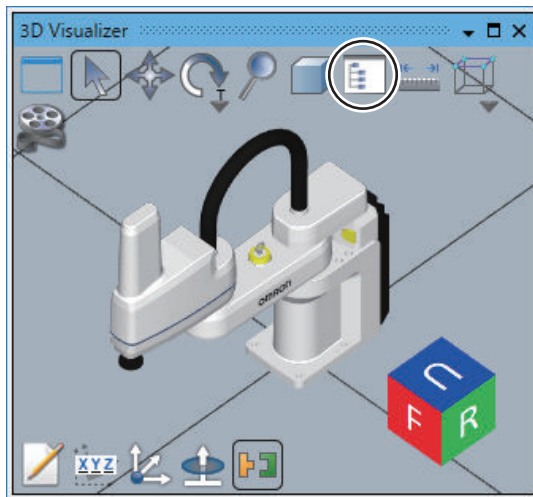

The **Scene Graph** dialog box is displayed.

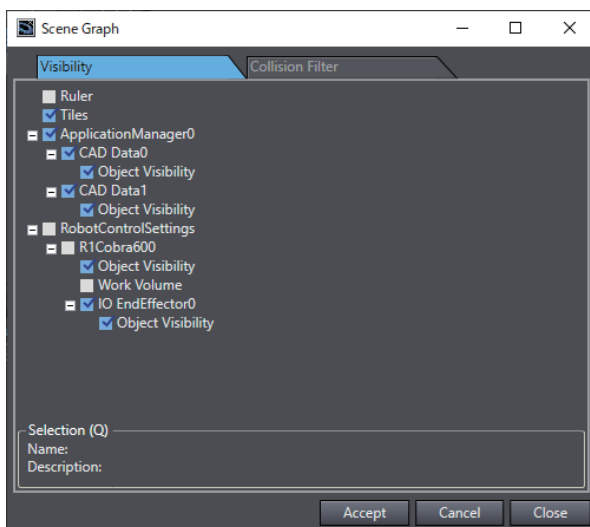



3 Click the **Collision Filter** tab.

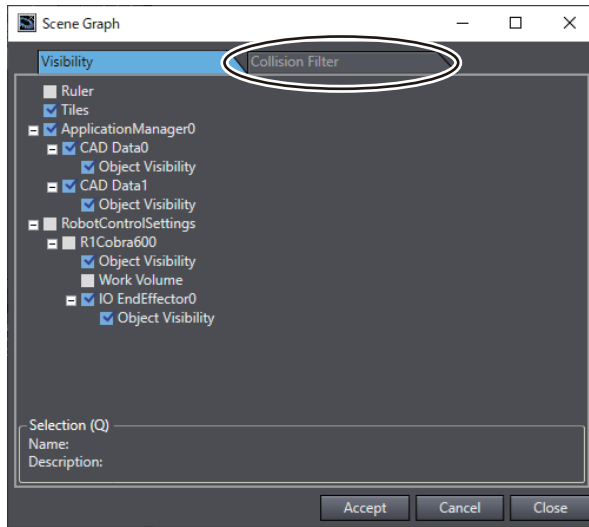

4 Click the **+** button in the **Collision Filter Group Items** column for the **Collision Filter Group**.

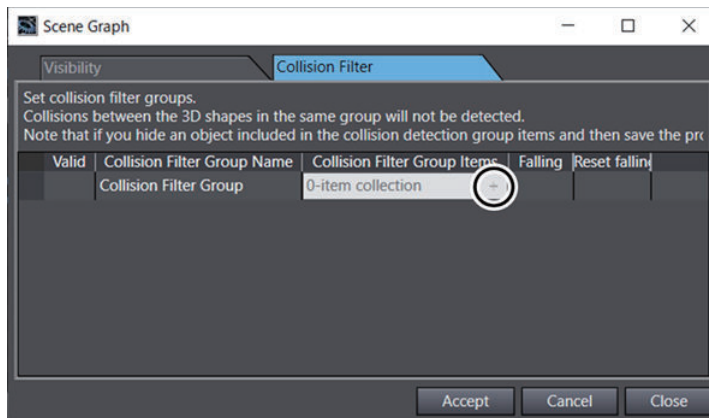

A new row with the **Collision Filter Group Name** set as **Group0** is added on the **Scene Graph** dialog box.

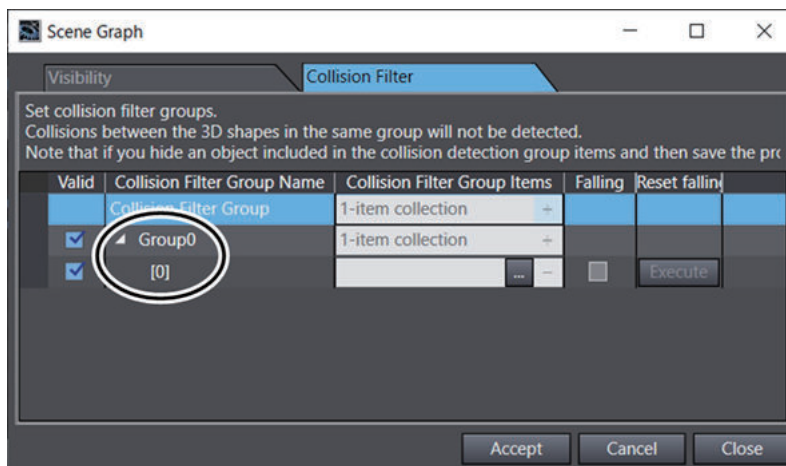

5 Repeat step 4 above.

A new row with the **Collision Filter Group Name** set as **Group1** is added on the **Scene Graph** dialog box.

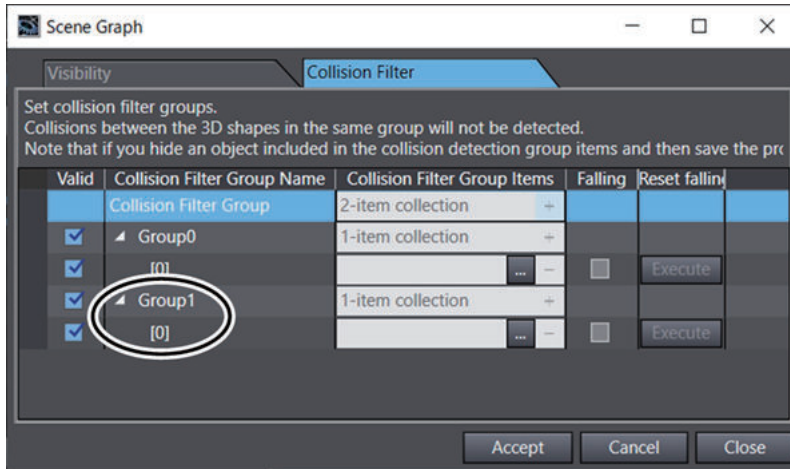

**6** Click the ... button in the **Collision Filter Group Items** column for **Group0 - [0]**.

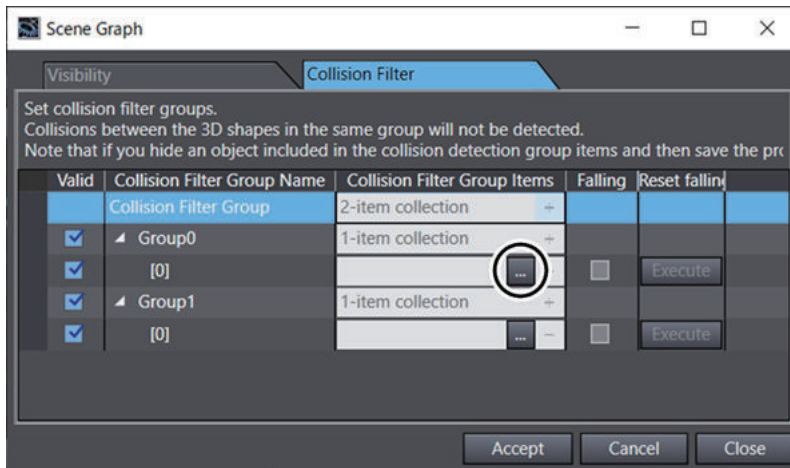

The **Select a collision filter group item** dialog box is displayed.

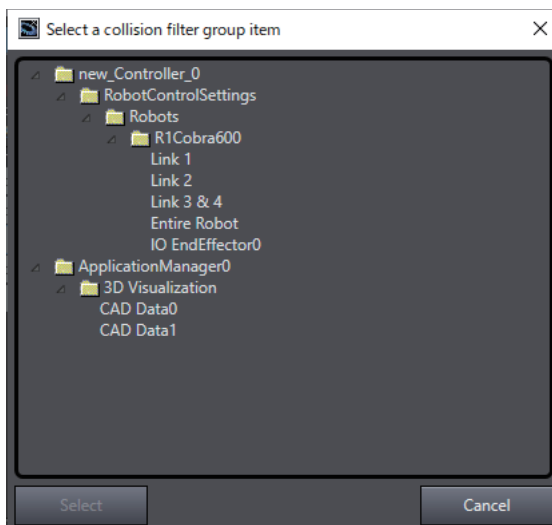

- 7 Select **new\_Controller\_0 - RobotControlSettings - Robots - R1Cobra600 - Entire Robot** in the tree, and then click the **Select** button.

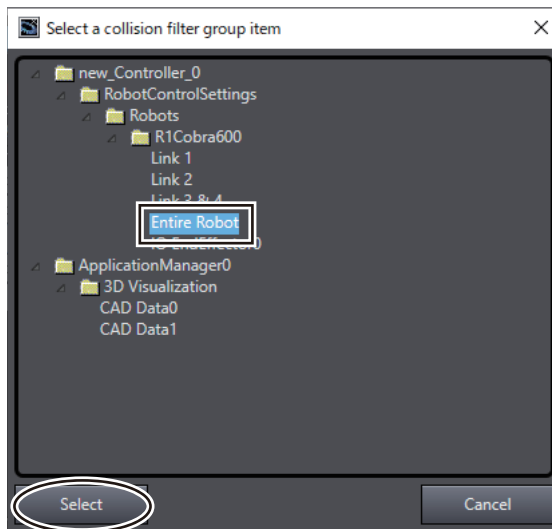

The **Select a collision filter group item** dialog box closes and the **Scene Graph** dialog box is displayed again. **R1Cobra600, Entire Robot** is registered as the **Collision Filter Group Items** for **Group0 - [0]**.

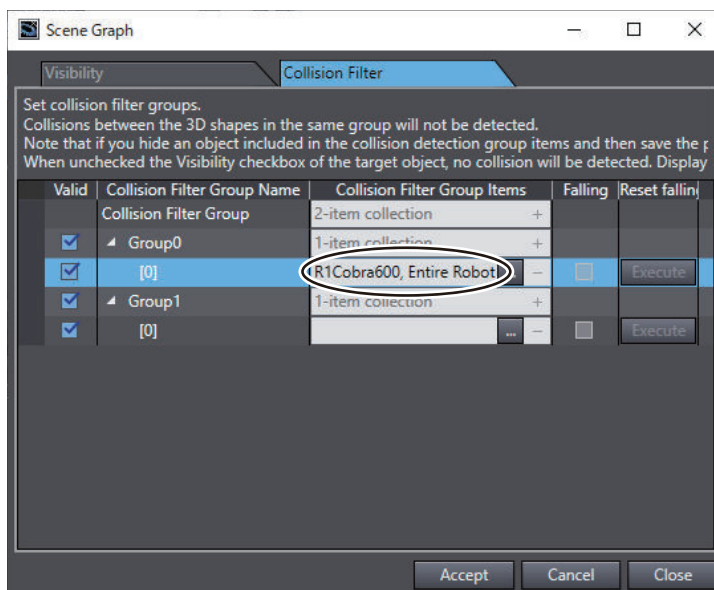

- 8 Click the **+** button in the **Collision Filter Group Items** column for **Group 0**.

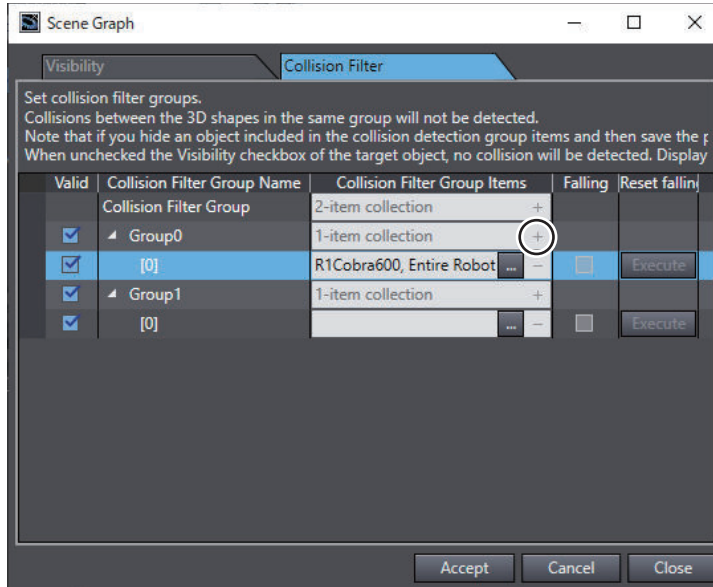

A new row [1] is added under **Group 0**.

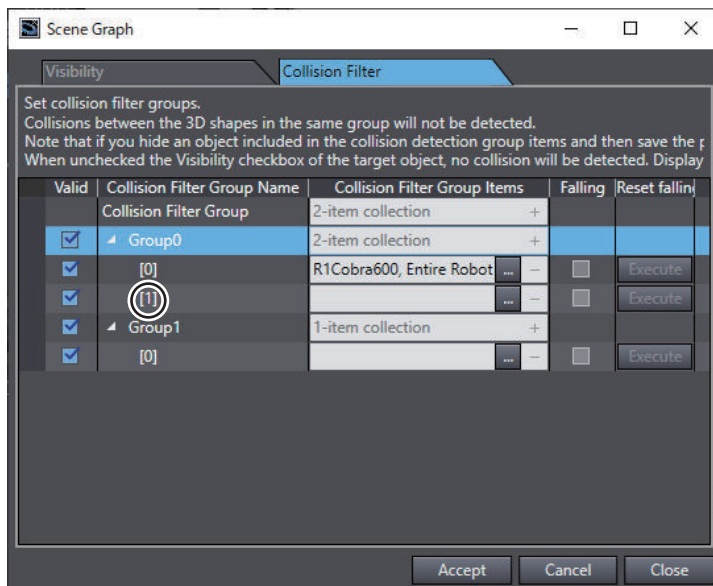

- 9 Click the ... button in the **Collision Filter Group Items** column for **Group 0 - [1]**.

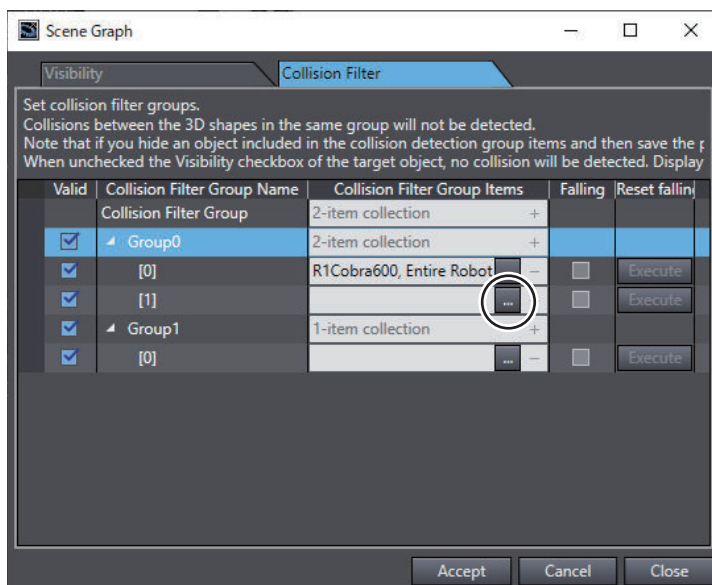

The **Select a collision filter group item** dialog box is displayed.

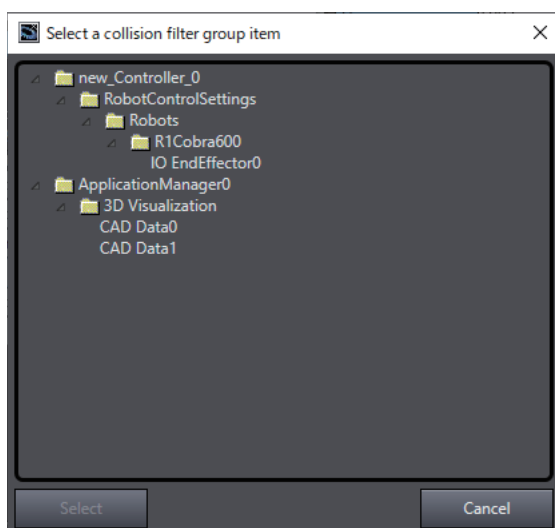

- 10** Select **new\_Controller\_0 - RobotControlSettings - Robots - R1Cobra 600 - IO EndEffector0** in the tree, and then click the **Select** button.

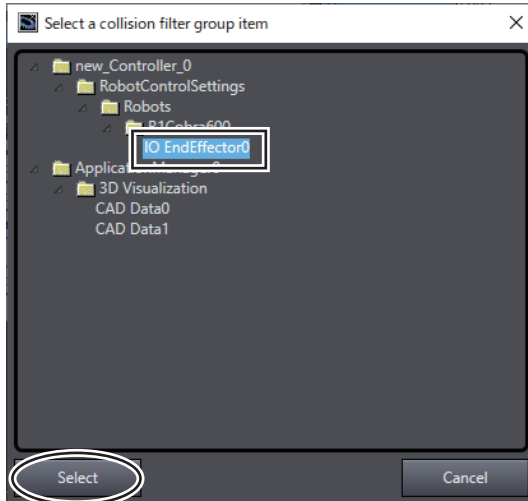

The **Select a collision filter group item** dialog box closes and the **Scene Graph** dialog box is displayed again. **IO EndEffector0(R1Cobra600)** is registered as the **Collision Filter Group Items** for **Group0 - [1]**.

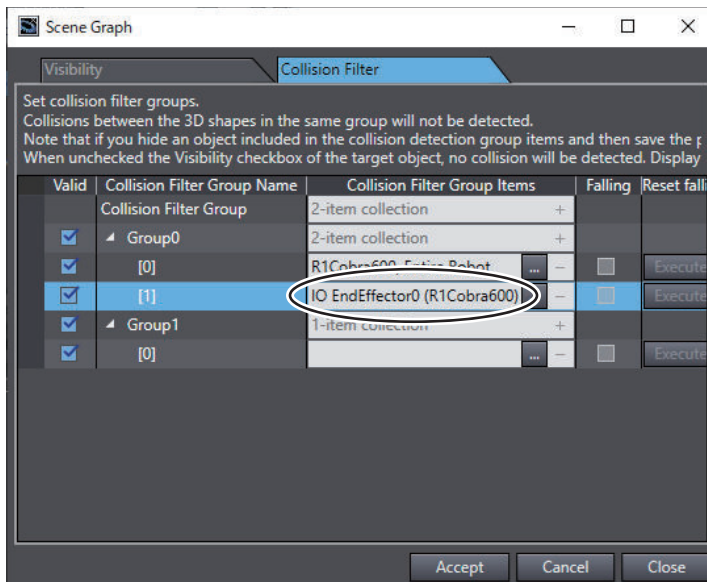

- 11** Click the ... button in the **Collision Filter Group Items** column whose **Collision Filter Group Name** is **Group1 - [0]**.

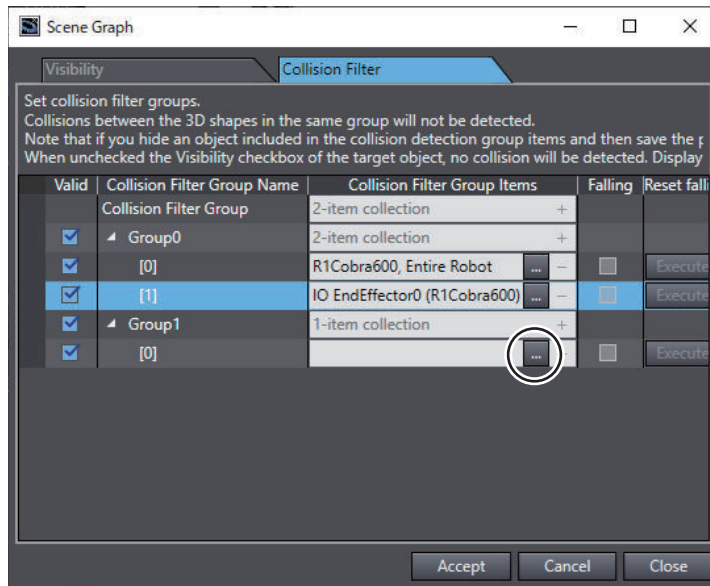

The **Select a collision filter group item** dialog box is displayed.

- 12** Select **ApplicationManager0 - 3D Visualization - CAD Data0** from the tree, and then click the **Select** button.

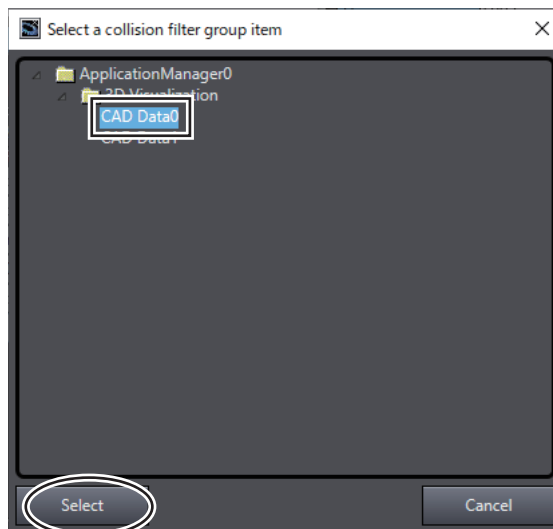

The **Select a collision filter group item** dialog box closes and the **Scene Graph** dialog box is displayed again. **CAD Data0** is registered to the **Collision Filter Group Items** column for **Group1 - [0]**.

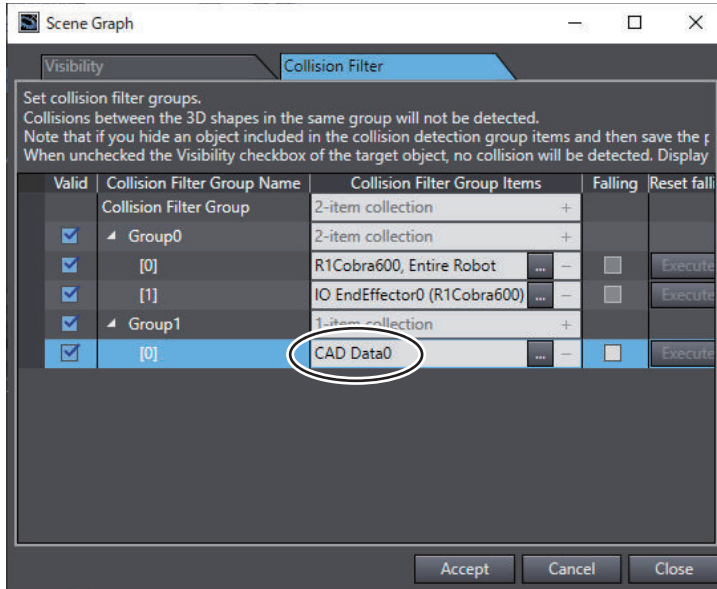

**13** Click the + button in the **Collision Filter Group Items** column for **Group1**.

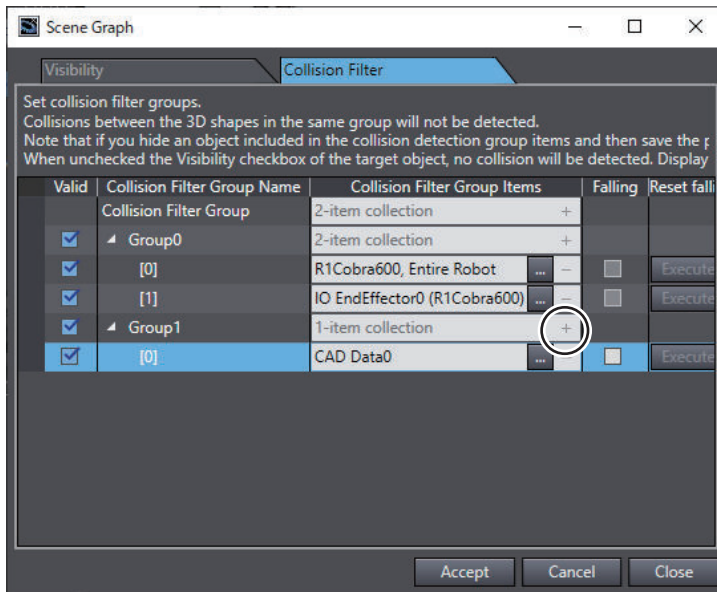

A new row for [1] is added under **Group1**.



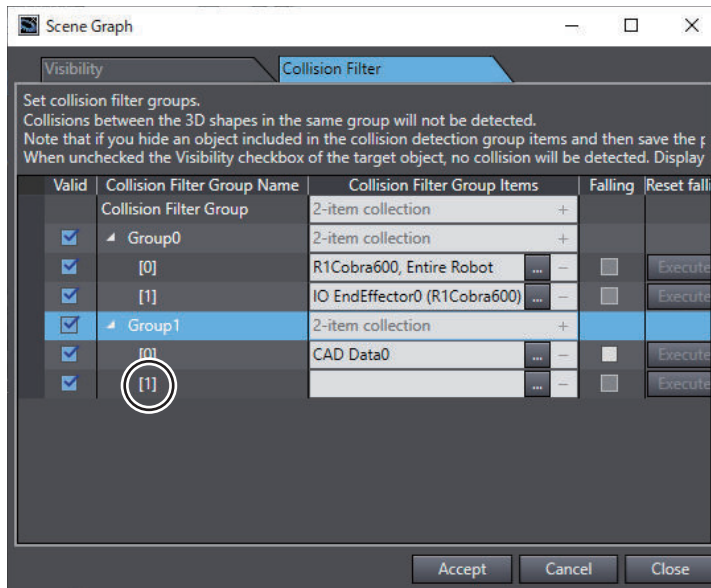

- 14** Follow the step 11 to 12 to register **CAD Data1** for **Group1 - [1]**.  
**CAD Data1** is registered to the **Collision Filter Group Items** column for **Group1 - [1]**.

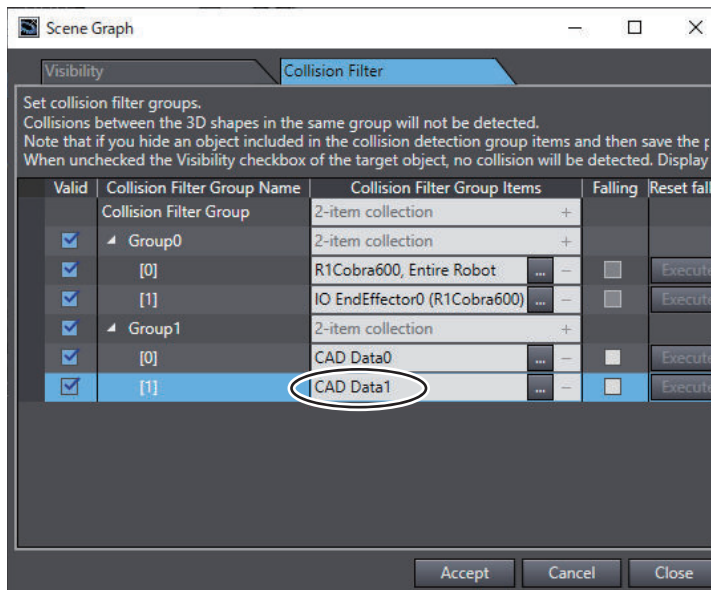

- 15** Check that the **Valid** check boxes are all selected. If there is a check box not selected, click it to select.

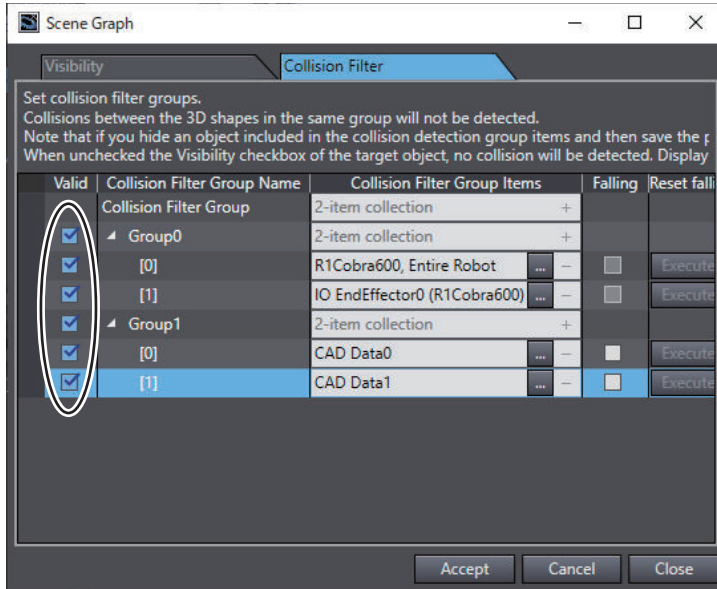

**16** Click the **Accept** button.  
A collision filter configuration is saved.

**17** Click the **Close** button in the **Scene Graph** dialog box.

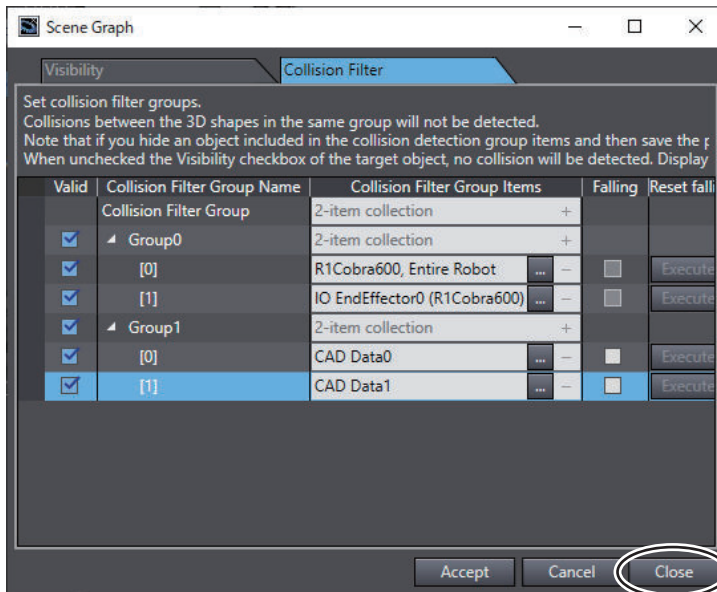

The **Scene Graph** dialog box is closed.

Now, the settings for checking the conflict between the robot, Conveyor A, and Conveyor B have been completed.

### 3-3-6 Starting Simulation

#### Enabling Robot Simulation Function

Enable the simulation function of the Sysmac Studio.

To simulate the operation of the robot, open the project file in EMULATION mode.

If you want to know whether the project file opened on the Sysmac Studio is in EMULATION mode or not, check the status bar on the main window. When you see **[Emulation Mode] Access Level: Engineer** on the status bar, the project is opened in EMULATION mode.

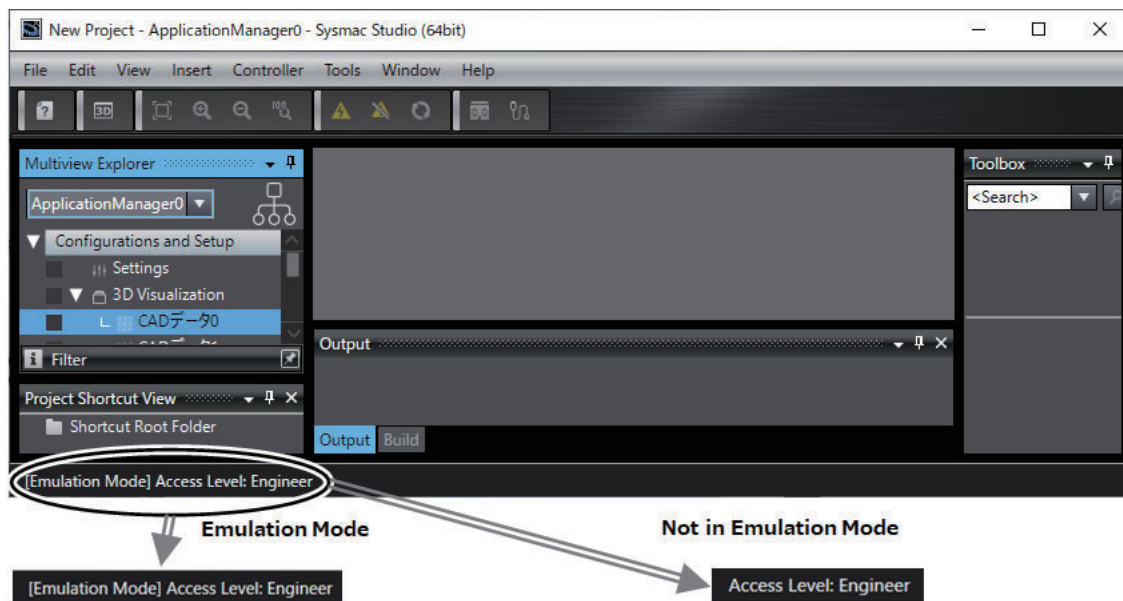

If the project is opened in a different mode, click the **Enable emulation mode** icon on the toolbar to change to EMULATION mode.



- 1 In the Multiview Explorer, select **new\_Controller\_0** from the device list.

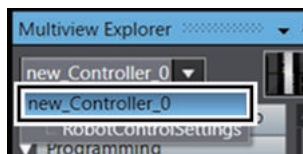

- 2 Select **Run** from the **Simulation** menu.  
The screen below is displayed while the simulator is starting.

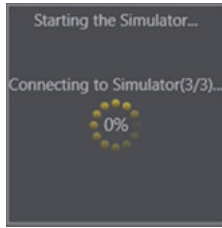

After this screen is closed, the lower part of the toolbar in the main window turns yellow-green.



### 3-3-7 Teaching Positions

This section describes the procedure to use the simulation function of the Sysmac Studio for teaching the positions.

The target of teaching in this equipment model is the wait position of the robot and the pick-up and place positions of the workpiece.

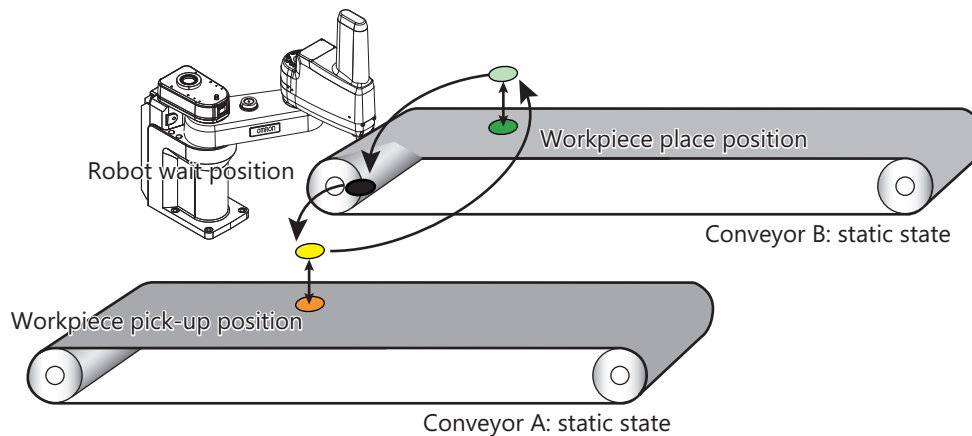

You can operate the robot during the simulation in either of the following two ways. Select one of the following depending on the positioning accuracy required for operation and movement.

- Manipulate the tool center point of the robot with the mouse in the 3D Visualizer
- Manipulate each axis of the robot in **V+ Jog Control** pane



#### Additional Information

- To move the robot to its approximate position, it is convenient to use the mouse and move the tool center point of the robot on the 3D Visualizer.
- To move the robot precisely to its correct position, manipulate each axis of the robot in the **V+ Jog Control** pane

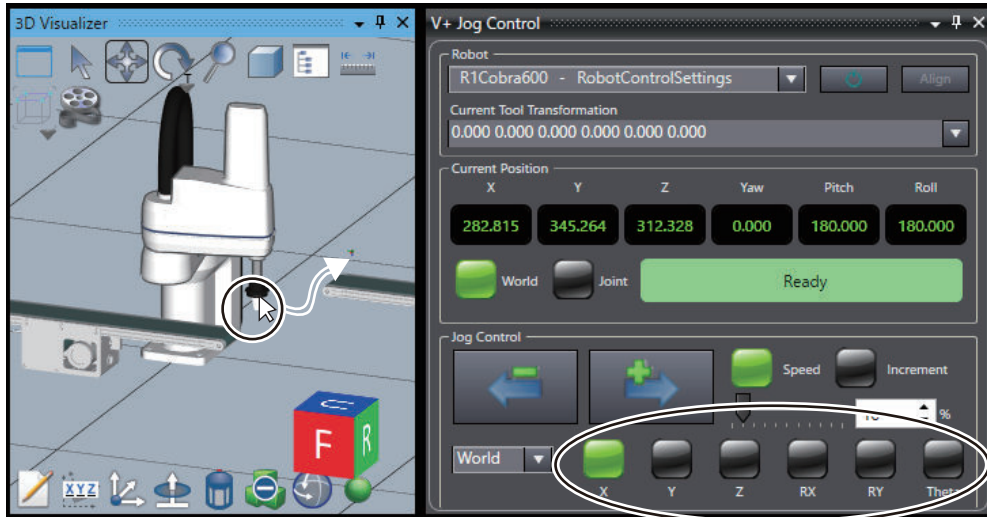

When teaching positions to the robot, you must store the position data of the robot in the V+ position variables. Here, create the following position variables.

Variable name	Data type	Application	Corresponding IEC variable
gl.pick	Location	Has the data of workpiece pick-up position.	eLoc_pick
gl.place	Location	Has the data of workpiece place position.	eLoc_place
gl.wait	Location	Has the data of robot wait position.	eLoc_wait

## Manipulating the Robot with the Mouse in the 3D Visualizer

This section describes the procedure to manipulate the tool center point of the robot with the mouse in the 3D Visualizer. This operation is suitable for determining rough position and posture, because the tool center point of the robot moves to follow the mouse cursor, enabling intuitive robotic operation.

- 1 Select **3D Visualizer** from the **View** menu on the main window of the Sysmac Studio.

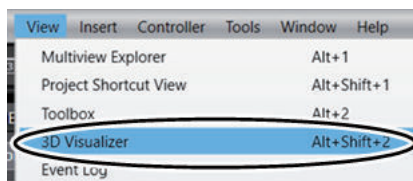

The 3D Visualizer is displayed on the right side of the main window.

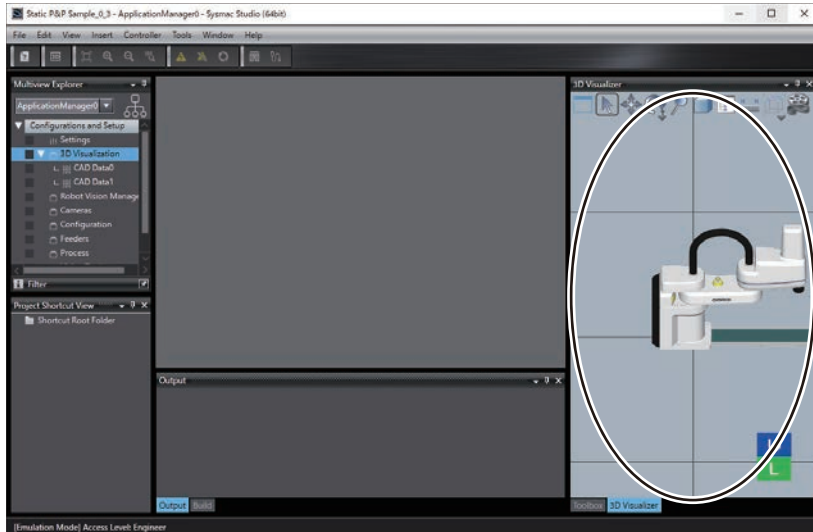

- 2 Move the mouse cursor to the tool center point of the robot and click on it.

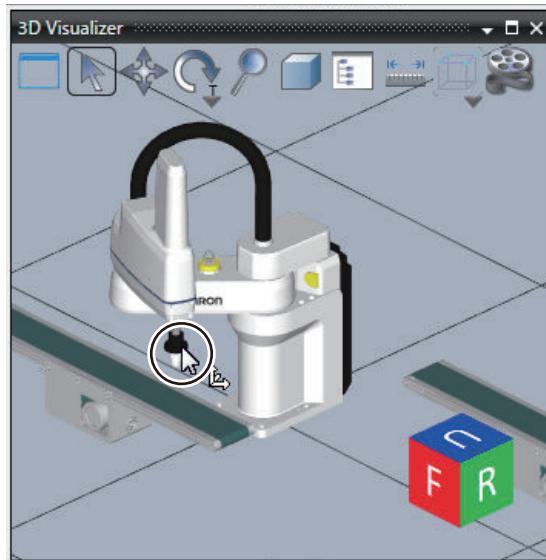

The outline of the robot is highlighted with black lines.

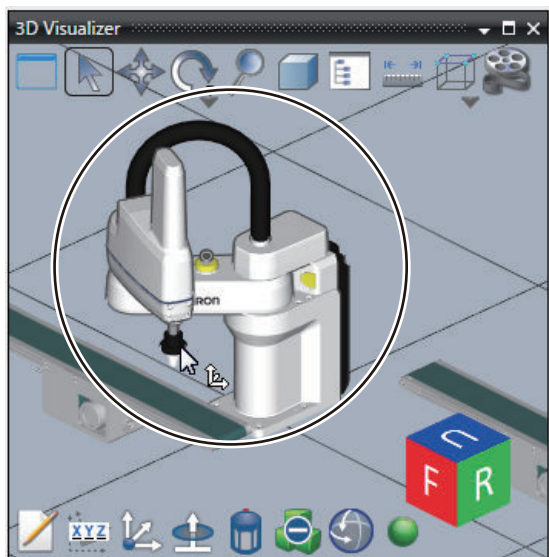

- 3** Drag the mouse cursor.  
The tool center point moves to follow the mouse cursor.

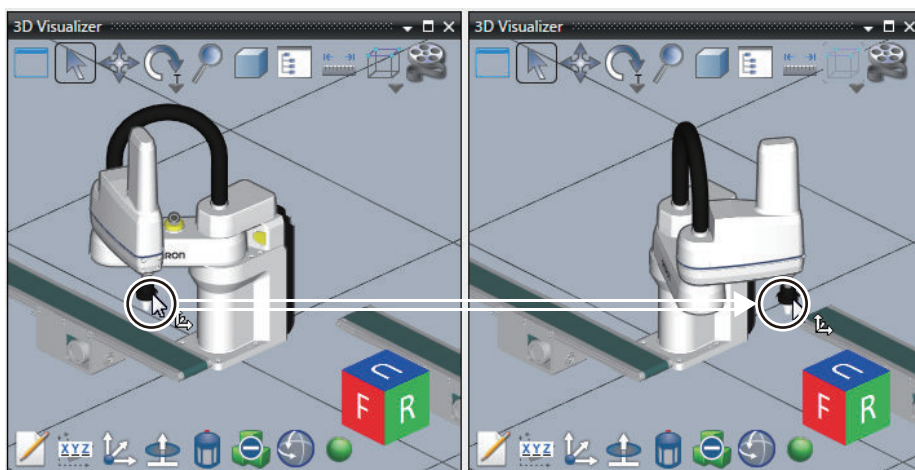

- 4** Move the tool center point to the position where it overlaps the conveyor, which is the position you specify.  
The collision detection function set in *Activating Collision Detection Function* on page 3-53 detects a collision between the end-effector and the conveyor, and the color of them changes to gray.

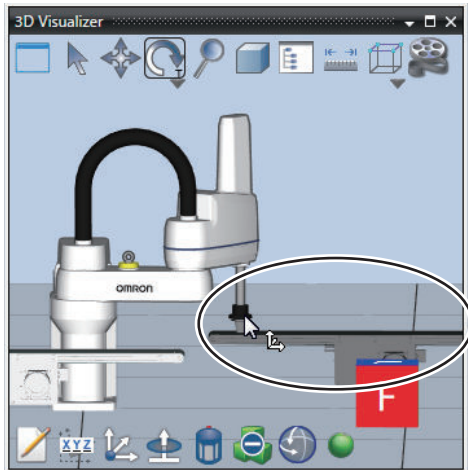

- 5 Drop with the mouse immediately after the color of the end-effector and the conveyor changes to gray.  
The robot will stop at the drop position.

The robot position is now determined. If you set the current position as the picking or placing position of the robot, proceed to *Saving Current Positions to Variables* on page 3-74. If you need to specify a more precise position or want to specify a position along the axis of the robot coordinate system or each joint axis, proceed to *Manipulating the Robot in the V+ Jog Control Pane* on page 3-70 for the next step.

## Manipulating the Robot in the V+ Jog Control Pane

This section describes the procedure to manipulate the robot in **V+ Jog Control** pane. Use this procedure to move the robot along the coordinate system or each joint axis of the robot.

- 1 Select **3D Visualizer** from the **View** menu on the main window of the Sysmac Studio.

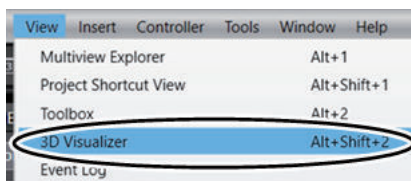

The 3D Visualizer is displayed on the right side of the main window.



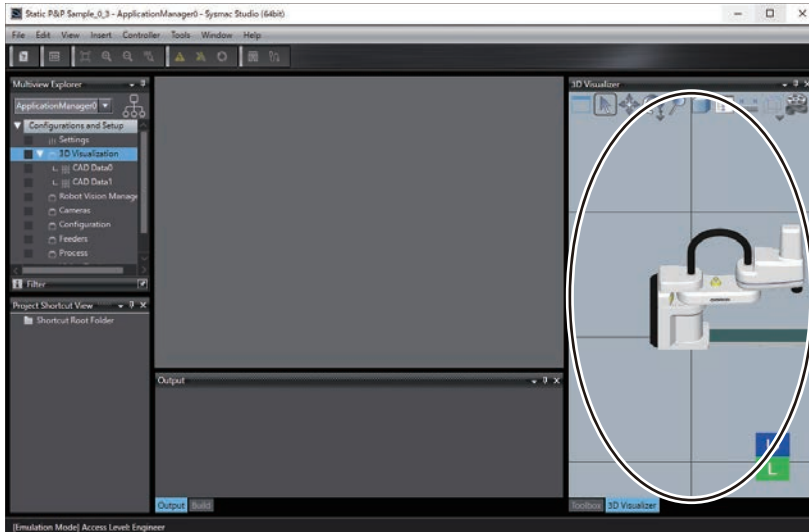

- 2 Select **RobotControlSettings** from the device list in the Multiview Explorer.

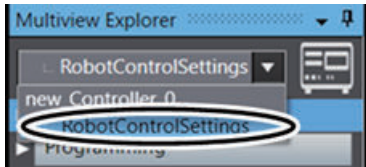

- 3 Select **V+ Jog Control** from the **View** menu on the main window.



The **V+ Jog Control** pane appears on the right side of the main window.







- 4 From the drop-down list of **Jog Control** on **V+ Jog Control** pane, select the coordinate system of **World**, **Joint**, or **Tool**.

When **World** is selected, positions of the robot can be specified in the robot coordinate system, and when **Joint** is selected, the position can be set in the coordinate system of the joint. Select **Tool** for specifying the position in the coordinate system of the tool center point. In this example, select **World**.



- 5 Click one of the lamps of **Jog Control** in the **V+ Jog Control** pane. The lamp clicked turns green. The robot can be moved along the coordinate axis of the illuminated lamp. Select the **Z** lamp in this example.



- 6 Press and hold the arrow button labeled  or  of **Jog Control** in the **V+ Jog Control** pane. The labels  and  on the arrow buttons represent positive or negative directions on the specified coordinate system. For example, the arrow in the figure below indicates positive direction in the robot coordinate system.

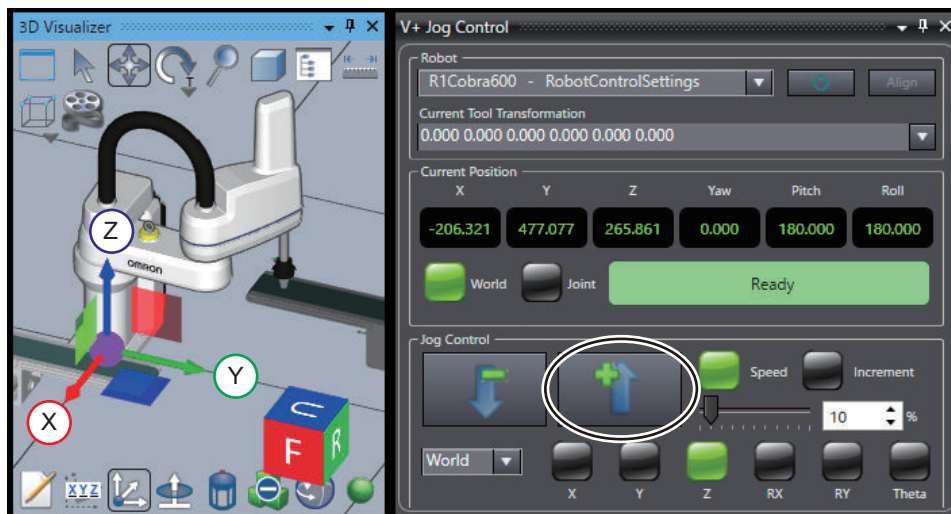

While the arrow button is kept pressed, the robot moves along the specified axis of the coordinate system.

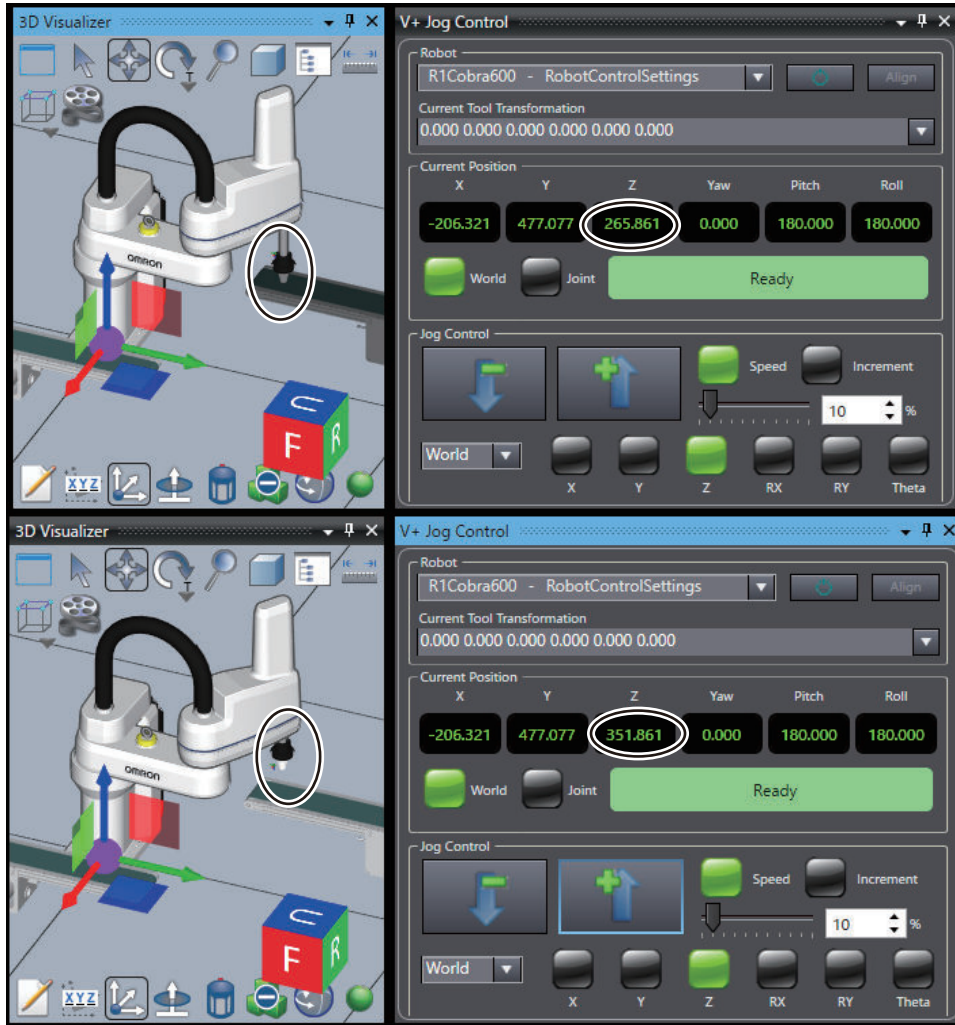

**7** Take step 4 to 6 again to move the robot to the position and posture you want to specify.

Now the robot position has been configured.

## Saving Current Positions to Variables

The current positions of the robot set by teaching must be saved in the V+ variables.

The procedure to save the current position of the robot to the already created V+ variable is described below.

V+ position variables that need to be saved are listed in the table below.

Name of position (Name of variable)	Description
gl.wait	Robot wait position
gl.pick	Workpiece pick-up position
gl.place	Workpiece place position

Save a current position to the variable *gl.wait* as an example. Save current positions to two other variables in the same manner.

- 1 Click **Location** in the **V+ Jog Control** pane.



The field to set the position variable is displayed.



- 2 Selects a variable that you want to set the current position or an element of the array variable from the drop-down list.



The variable name and values set in the selected variable are displayed.



Select the variable *gl.wait*.

- 3 Click the **Here** button of **Location** in the **V+ Jog Control** pane.



The current position is registered to the value of the selected variable.



Now you have registered the current position of the robot to the V+ variable.



#### Additional Information

When the sequence control program controls the robot operation, the variable copy program "lccopy" copies the position variables of the V+ program to the shared variables of the sequence control program.

### 3-3-8 Setting up Automatic Loading of V+ Programs and Variables at Power ON

The V+ programs that you created and V+ global variables are not automatically loaded to the Robot Integrated CPU Unit by default settings of the project when power to the Robot Integrated CPU Unit is turned ON.

This section describes the setting procedure for automatically loading the V+ programs and V+ global variables to the Robot Integrated CPU Unit when its power is turned ON.

If you want to control the operation with the sequence control program, step 4 to 6 are unnecessary.

- 1 Select **RobotControlSettings** from the device list in the Multiview Explorer.

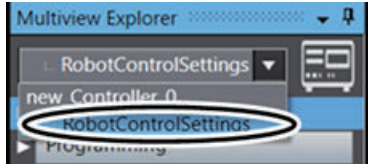

- 2 Click **Configurations and Setup** in the Multiview Explorer.

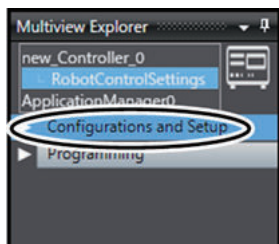

Setting items are displayed under **Configurations and Setup** in the tree.

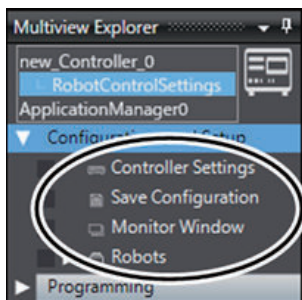

- 3 Double-click **Save Configuration**.

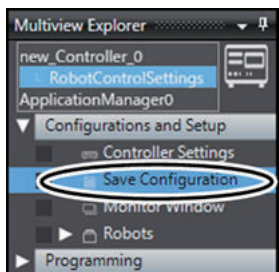

The **Save Configuration** tab page is displayed in the Edit Pane.



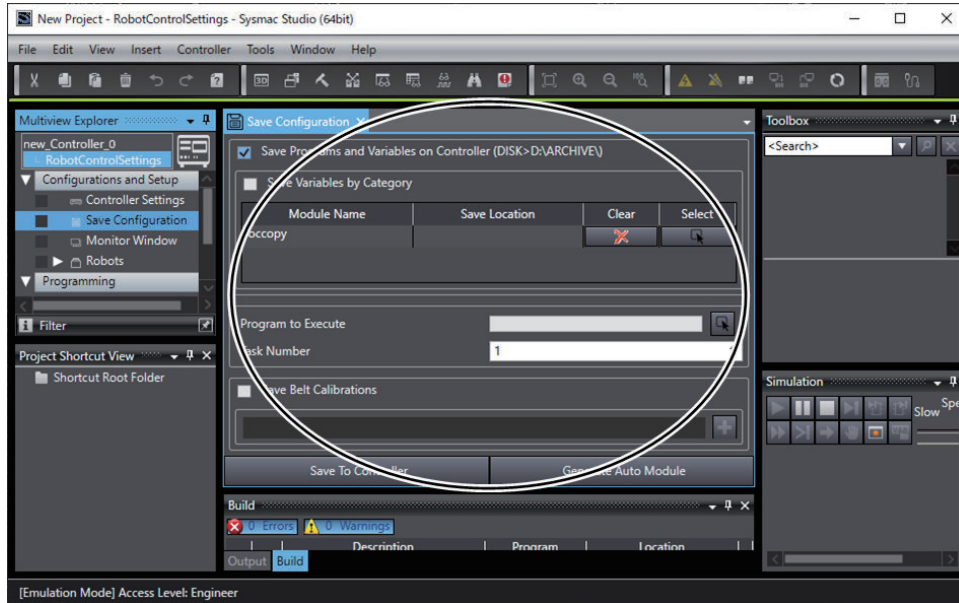

When the V+ programs are used to control the operation, proceed to step 4.  
 If the system is controlled by the sequence control program, proceed to step 7.

- 4 Make sure that *supervisor* is not selected for **Program to Execute** and click the button on the right.



The **Select the startup program** dialog box appears.

- 5 Select **supervisor** under **supervisor** and click the **Select** button.

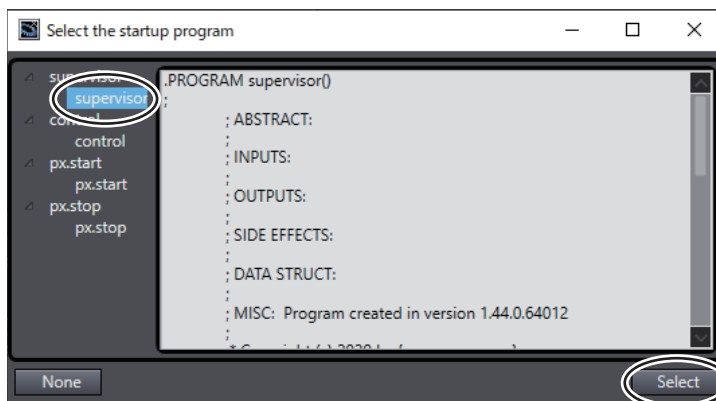

- 6 Enter 0 to **Task Number**.

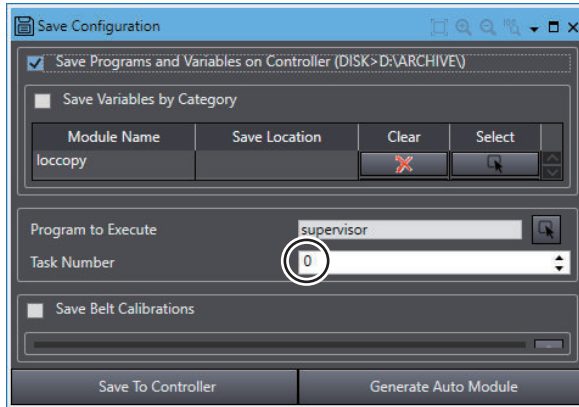

7 Click the **Generate Auto Module** button in the **Save Configuration** tab page.

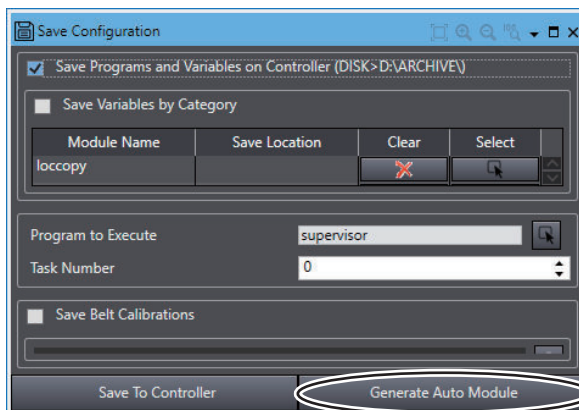

The module name **auto** is added to the module list in the **Save Configuration** tab page. In the tree of the Multiview Explorer, **V+ Modules - auto** are added under **Programming**.

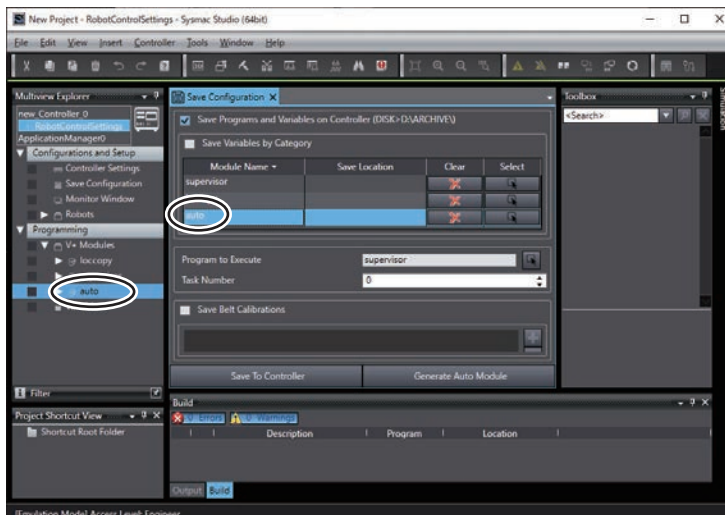

8 Select **Save** from the **File** menu.

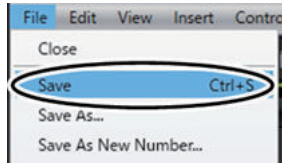

The Robot Integrated CPU Unit is now configured to automatically load the V+ programs and V+ global variables when it is powered ON. The program **auto** starts automatically when the Robot Integrated CPU Unit is powered ON and reads the saved V+ programs and V+ global variables.

The program **auto** is created in a form called command program, which is different from the V+ program. For details about the command program, refer to the *eV+3 User's Manual (Cat. No. 1651)*.

### 3-3-9 Running the Program and Checking Operation

This section describes the procedure to run and simulate the sequence control program created in 3-3-3 *Creating a Sequence Control Program* on page 3-22.

You can run the program by changing the global variable *gStart* in the sequence control program from FALSE to TRUE in the Watch Tab Page.

The V+ program is called from the sequence control program executed in this procedure.



#### Precautions for Correct Use

When you perform this procedure, check that the project file has been opened in EMULATION mode. Refer to *Enabling Robot Simulation Function* on page 3-65 for the checking procedure.



#### Additional Information

Refer to the *Sysmac Studio Version 1 Operation Manual (Cat. No. W504)* and *Sysmac Studio Robot Integrated System Building Function with Robot Integrated CPU Unit Operation Manual (Cat. No. W595)* for details on the debugging function of the program.

When you control the operation with the V+ programs, start from step 1.

To control the operation with the sequence control programs, start with step 3.

- 1 Select **RobotControlSettings** from the device list in the Multiview Explorer.

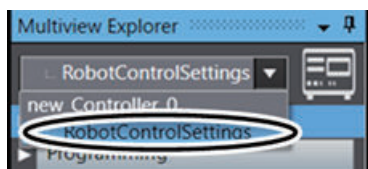

- 2 On the Multiview Explorer, select **Programming – V+ Modules – supervisor - supervisor** and right-click on it, and then select **Execute on Task – Task 0**.

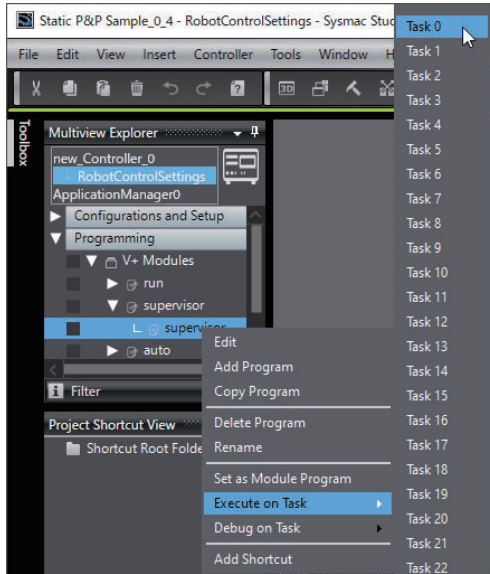

The V+ program supervisor starts to run in Task 0.

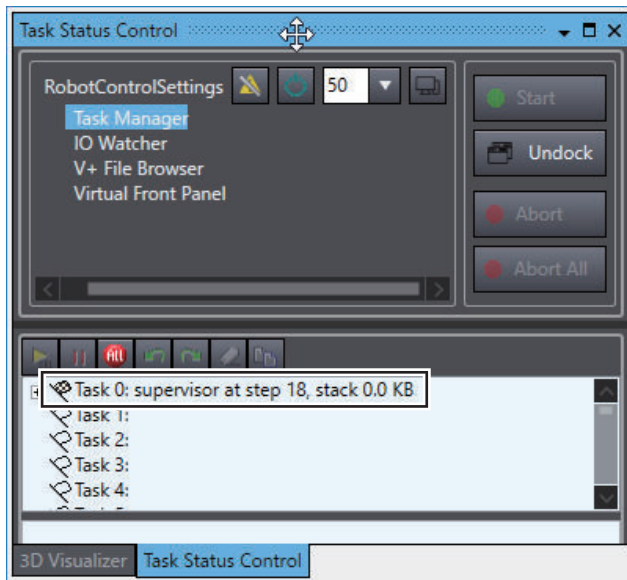

- 3 In the Multiview Explorer, select **new\_Controller\_0** from the device list.

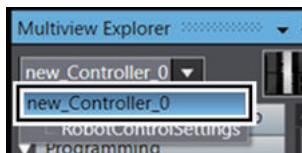

- 4 Select **3D Visualizer** from the **View** menu on the main window of the Sysmac Studio.

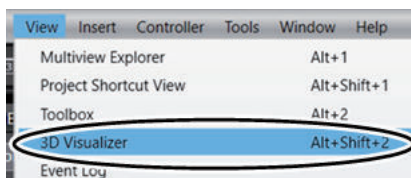

The 3D Visualizer is displayed on the right side of the main window.

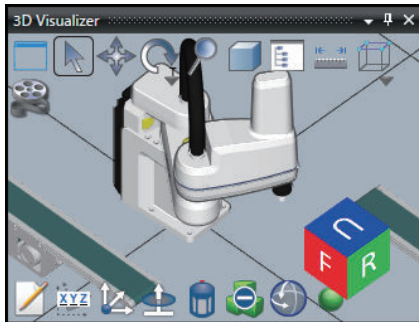

- 5 Select **Watch Tab Page** from the **View** menu on the main window.

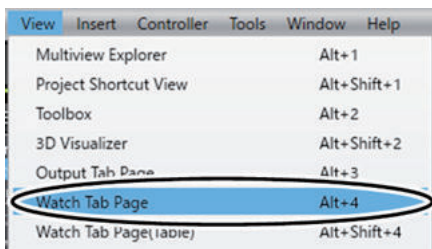

The **Watch (Project)1** tab page appears at the bottom of the main window.

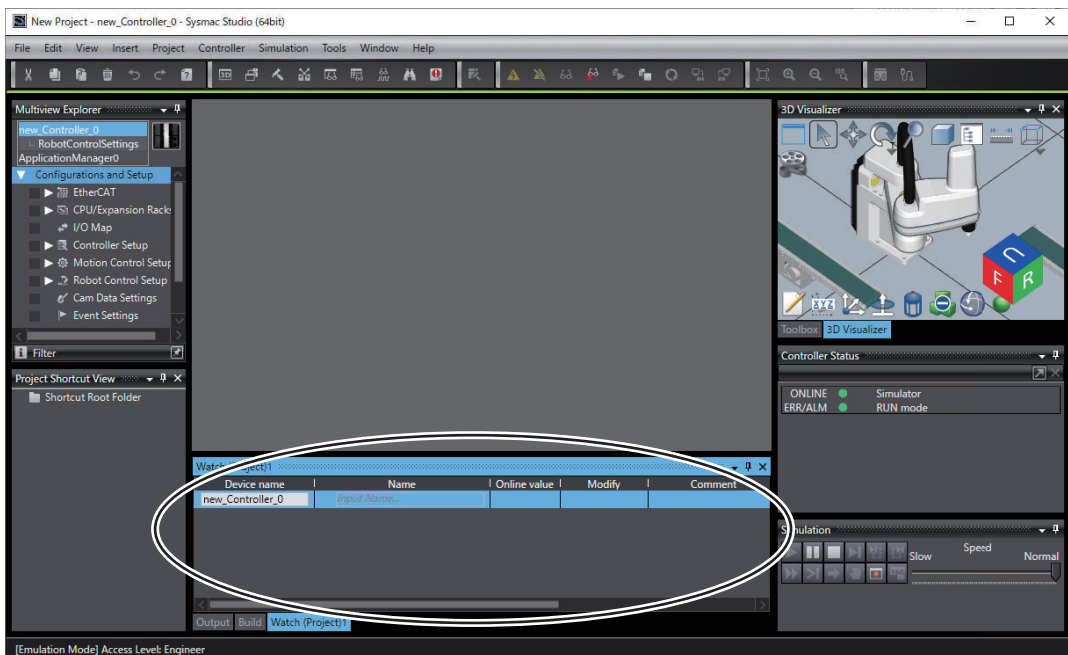

- 6 Type *gStart* in the **Name** column on the **Watch (Project)1** tab page. The **Online value** column displays the current value of **False** for the internal variable **gStart** in **Program0**.



- 7 Click the **TRUE** button in the **Modify** column for the variable **gStart** in the **Watch (Project)1** tab page.

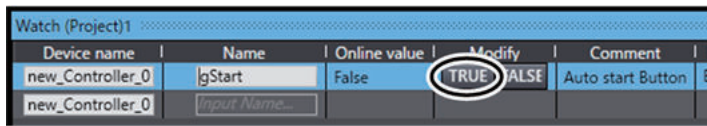

The robot starts to move and pauses at the workpiece pick-up position in the 3D Visualizer.

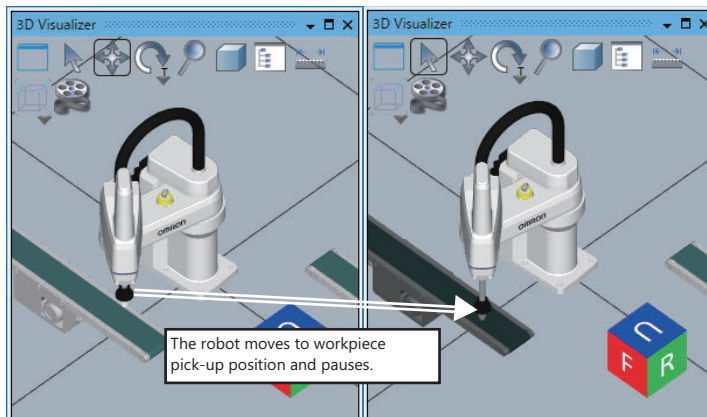

After that, the robot restarts operation from the workpiece pick-up position, moves to the robot wait position via the workpiece place position, and stops.

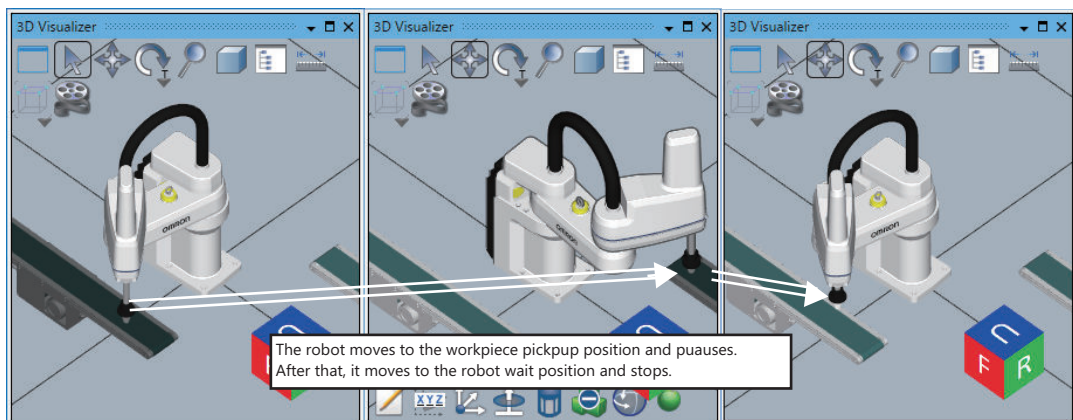

During operation, check that the robot does not turn gray in locations other than the workpiece pick-up position and workpiece place position. If the color changes to gray, the robot and the conveyor are interfering with each other. In that case, refer to *Manipulating the Robot in the V+ Jog Control Pane* on page 3-70 and move the workpiece pick-up approach point or the workpiece place approach point to a higher position by teaching.

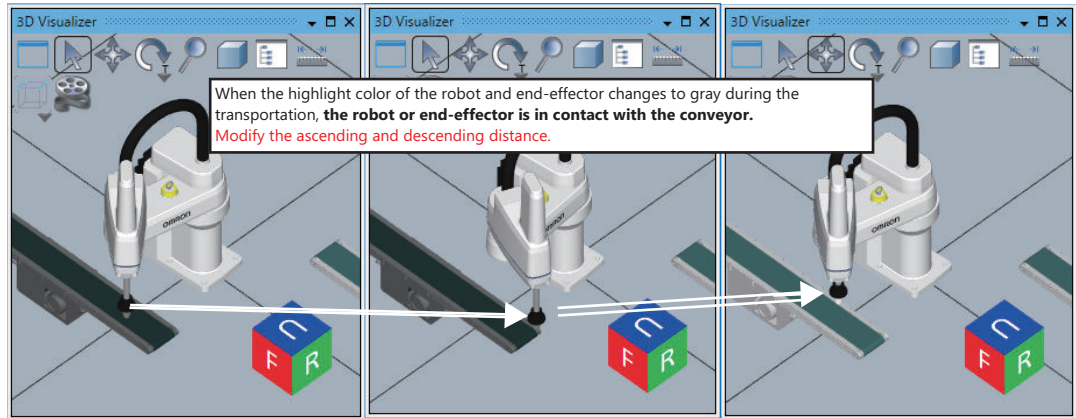

Now you finished checking operation of the sequence control program and V+ programs.

## 3-4 Installing and Wiring the System

In the system configuration, you must wire the signal lines covered in the colored areas in the figure below and set the node address of the robot.

- Wiring between the Robot Integrated CPU Unit (A) and the EtherCAT Digital I/O Terminal (F)
- Wiring between the EtherCAT Digital I/O Terminal (F) and the robot (C)
- Wiring between the Robot Integrated CPU Unit (A) and the computer (E)
- Wiring between the robot (C) and the T20 pendant (I)
- Wiring between the robot (C) and the front panel (K)
- Wiring between the EtherCAT Digital I/O Terminal (F) and the solenoid valve (Q)

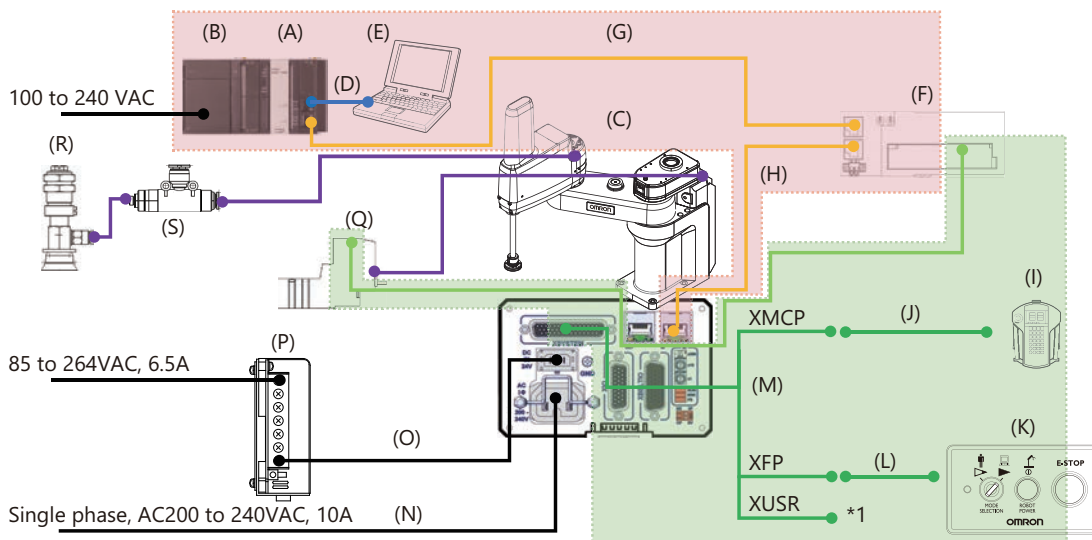

Refer to *1-3 System Configuration for Static Pick-and-place Equipment* on page 1-4 for information on the parts used in the system configuration.

Refer to the manual for the specific product for details on power lines not covered in the colored area as well as for ducting from the robot.

### 3-4-1 Wiring the Robot Integrated CPU Unit and the EtherCAT Digital I/O Terminal

You must wire the Robot Integrated CPU Unit and the EtherCAT Digital I/O Terminal.

- 1 Connect the EtherCAT port of the Robot Integrated CPU Unit and the EtherCAT IN port of the EtherCAT Digital I/O Terminal with an Ethernet cable.



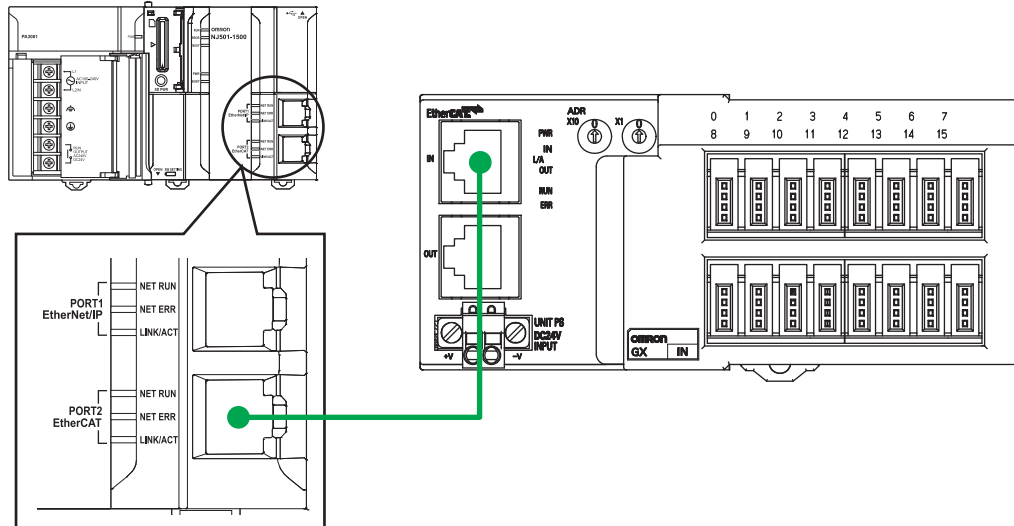

### 3-4-2 Setting the Node Address of the EtherCAT Digital I/O Terminal

You must set the EtherCAT node address of the EtherCAT Digital I/O Terminal.

- 1 Use the switches on the EtherCAT Digital I/O Terminal to set the EtherCAT node address. To set the node address to 1, set the x10 switch to 0 and the x1 switch to 1.

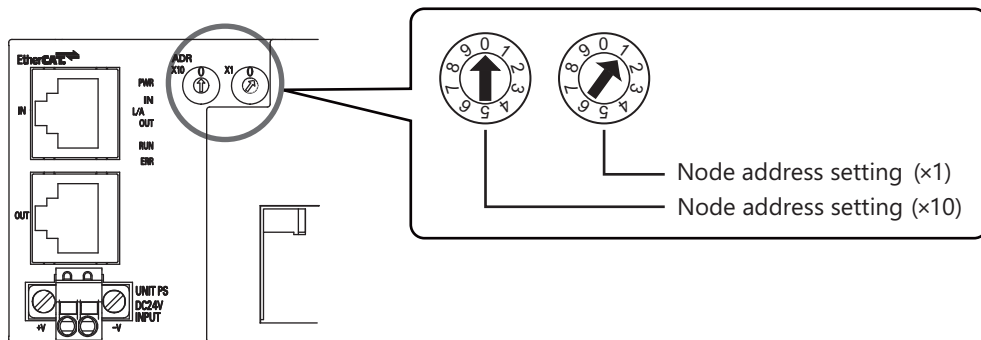

#### Precautions for Correct Use

Set the EtherCAT node address of the EtherCAT Digital I/O Terminal to be the same as the node address set in 3-3-2 *Creating the EtherCAT Network Configuration* on page 3-20.

### 3-4-3 Wiring the EtherCAT Digital I/O Terminal and the Robot

You must wire the EtherCAT Digital I/O Terminal and the robot.

- 1 Connect the EtherCAT OUT port of the EtherCAT Digital I/O Terminal and the EtherCAT IN port on the interface panel of the robot with an Ethernet cable.

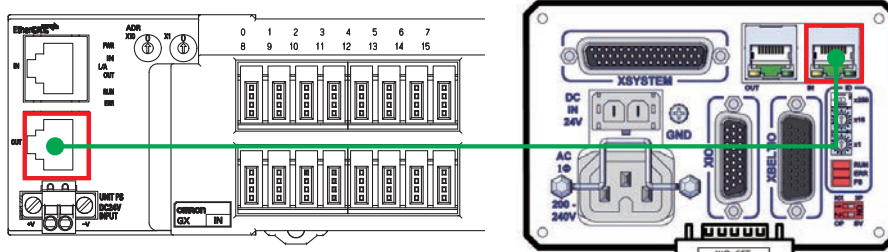

#### Precautions for Correct Use

Refer to the *NJ/NX-series CPU Unit Built-in EtherCAT Port User's Manual (Cat. No. W505)* for details on the Ethernet cable to be used.

### 3-4-4 Setting the EtherCAT Node Address of the Robot

You must set the EtherCAT node address of the robot.

- 1 Use the switches on the interface panel of the robot to set the EtherCAT node address. To set the node address to 2, set the x256 switch to OFF, the x16 switch to 0, and the x1 switch to 2.

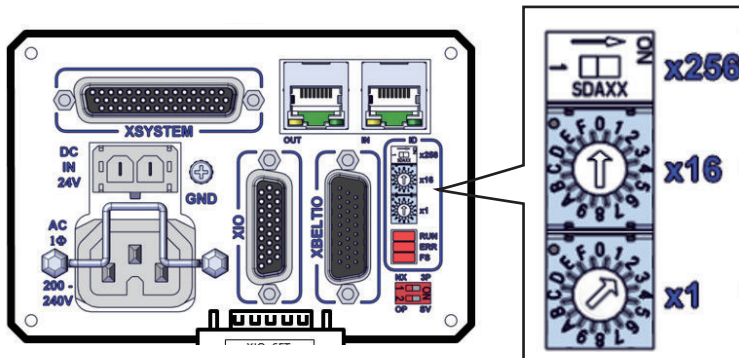

#### Precautions for Correct Use

Set the EtherCAT node address of the robot to be the same as the node address set in 3-3-2 *Creating the EtherCAT Network Configuration* on page 3-20.

Refer to the manual for your robot on how to set the node address.

### 3-4-5 Wiring the Robot Integrated CPU Unit and the Computer

You must wire the Robot Integrated CPU Unit and the computer.

- 1 Connect the built-in EtherNet/IP port of the Robot Integrated CPU Unit and the computer with an Ethernet cable.

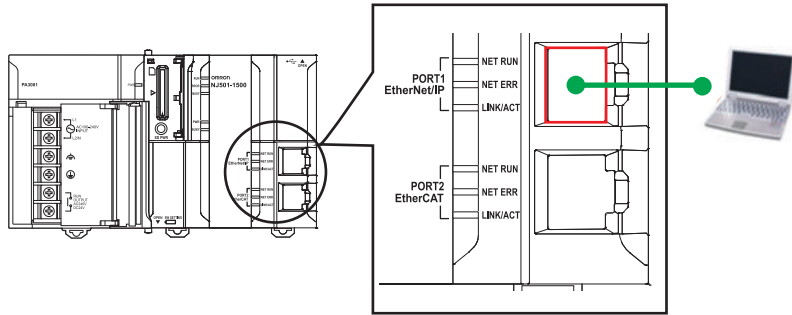

### 3-4-6 Wiring the Robot, T20 Pendant and the Front Panel

You must wire the robot and the T20 pendant, as well as the robot and the front panel. Use an XSYSTEM cable assembly, a T20 adapter cable, and a front panel cable for wiring.

- 1 Connect the robot and the XSYSTEM cable assembly.

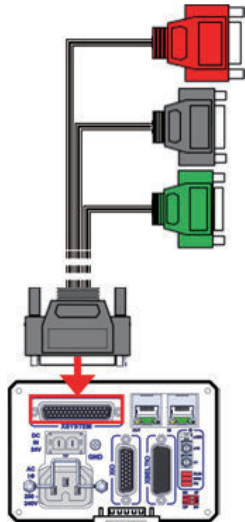

- 2 Connect the XMCP connector (Red) of the XSYSTEM cable assembly and the T20 adapter cable.

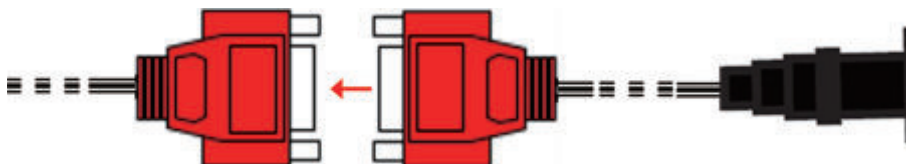

- 3 Connect the T20 adapter cable to the T20 pendant.



- 4** Connect the XFP connector (Green) of the XSYSTEM cable assembly and the front panel cable.

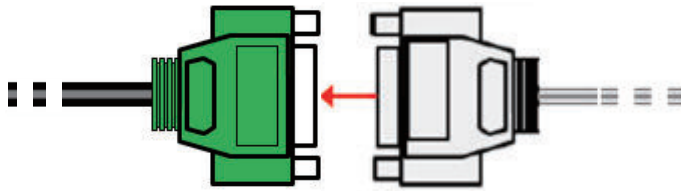

- 5** Connect the front panel cable and the front panel.

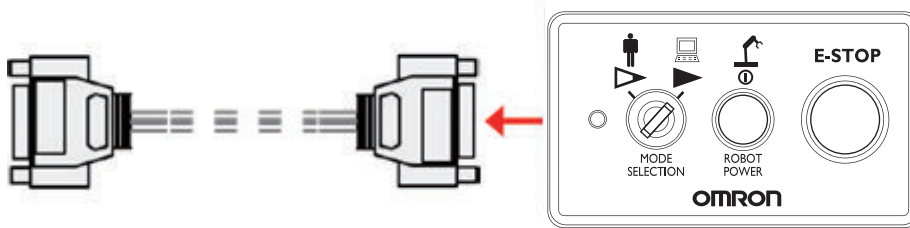

#### 3-4-7 Wiring the EtherCAT Digital I/O Terminal and Solenoid Valve

You must wire the EtherCAT Digital I/O Terminal and the solenoid valve.

Refer to the manuals for the EtherCAT Digital I/O Terminal and the solenoid valve for details on the cable wiring, and make the cable appropriately in accordance with the wiring diagrams and specifications.

- 1** Make the cable so that the solenoid valve will behave as shown in the table below.

Output value of Digital I/O Terminal	Solenoid valve behavior
FALSE	Duct is closed
TRUE	Duct is open

- 2** Wire the EtherCAT Digital I/O Terminal and the solenoid valve.

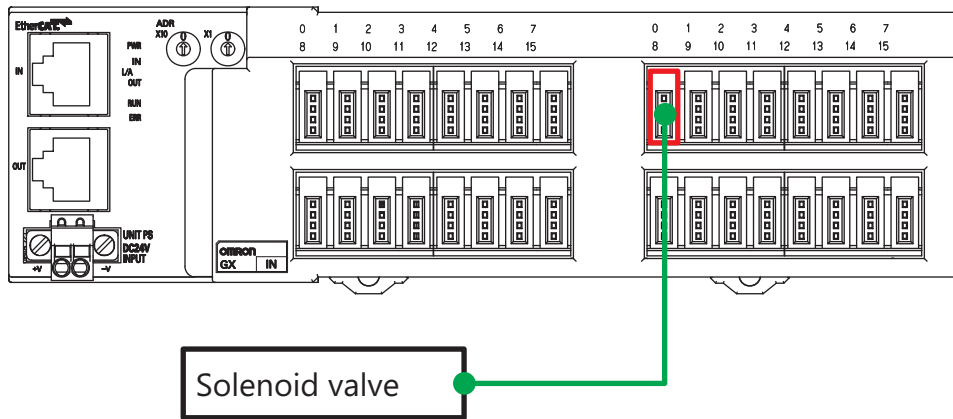

## 3-5 Setup Procedure for Actual System

This section describes the procedures for checking operation and adjusting the system on the actual system.

Check operation with the simulation function before you check operation on the actual system.



### Precautions for Correct Use

When you operate the robot in MANUAL mode with the T20 pendant, you must plug the iCS Commissioning Jumper into the XBELTIO connector and change the setting for the Teach Restrict. Refer to the *eCobra 600 and 800 Robot with EtherCAT User's Guide (Cat. No. I653)* for details.

### 3-5-1 Connecting Online

The computer and the Robot Integrated CPU Unit are connected online.

- 1 Turn ON the power supplies to the Robot Integrated CPU Unit and the robot.
- 2 Click **new\_Controller\_0** from the device list in the Multiview Explorer of the Sysmac Studio.

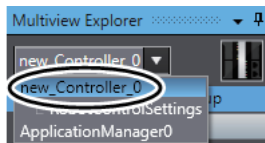

- 3 Select **Controller - Communications Setup** from the menu bar in the main window.

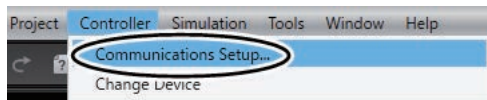

The **Communications Setup** dialog box is displayed.

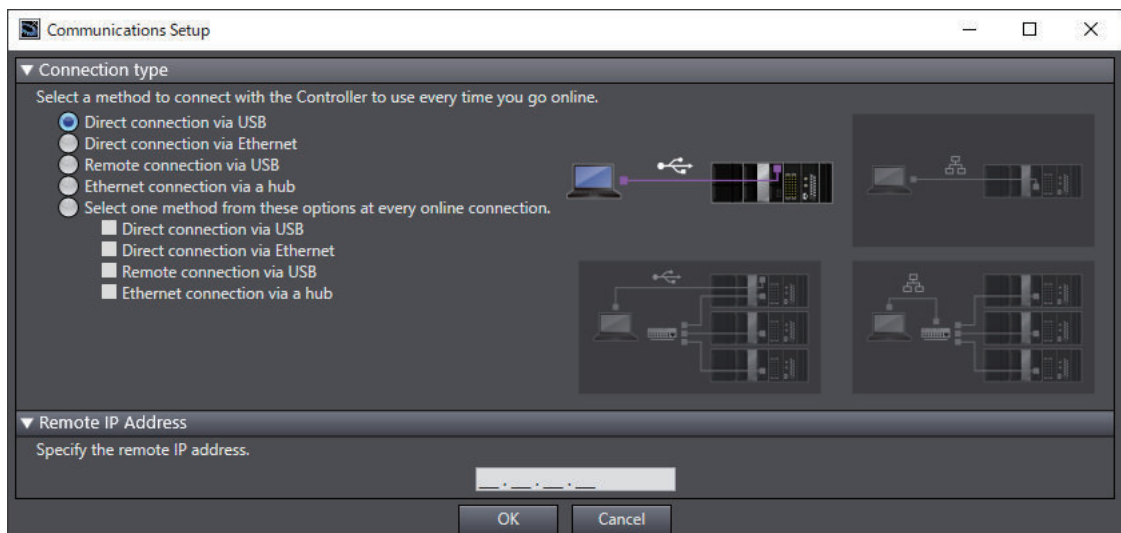

- 4 Click the **Direct connection via Ethernet** from the Communication type, and then click the **OK** button.

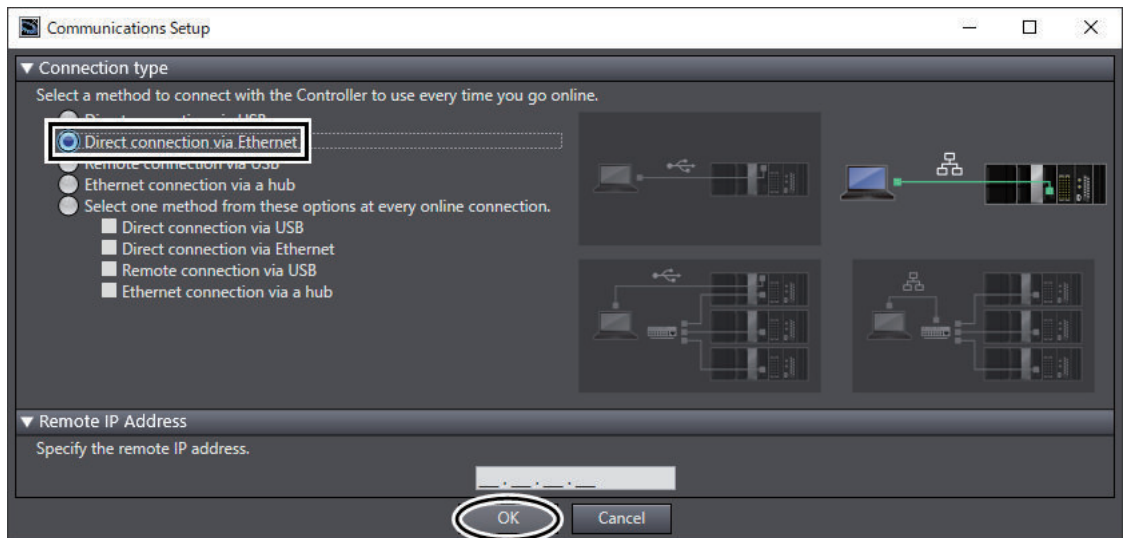

The **Communications Setup** dialog box is closed.

- 5 Click the **Disable emulation mode** icon in the toolbar.



The confirmation dialog box for Disable emulation mode is displayed.

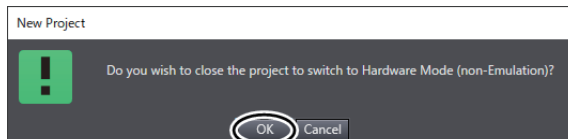

- 6 Click the **OK** button.  
The main window is displayed again after the Sysmac Studio returns to the menu screen.

- 7 Select **Controller - Online** from the menu bar.

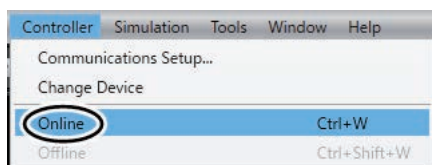

### Precautions for Correct Use

Depending on the status of the connected Robot Integrated CPU Unit, the dialog box for writing the CPU Unit name or checking the serial ID is displayed. Refer to the *Sysmac Studio Version 1 Operation Manual (Cat. No. W504)* for details.

When it is online, the yellow line is displayed on the top of the edit pane.

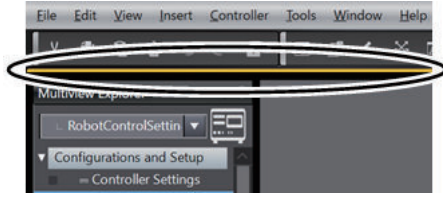

## 3-5-2 Transferring Settings and Programs

The settings and programs in the project file are transferred from the Sysmac Studio to the Robot Integrated CPU Unit.

- 1 Select **Controller - Synchronize** from the menu bar on the Sysmac Studio.

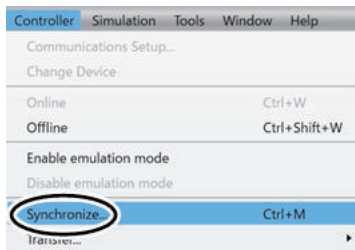

The comparison of the user program and parameter settings between the Sysmac Studio and the Controller is started.

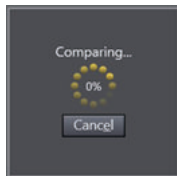

When the comparison is completed, the Synchronization dialog box is displayed.

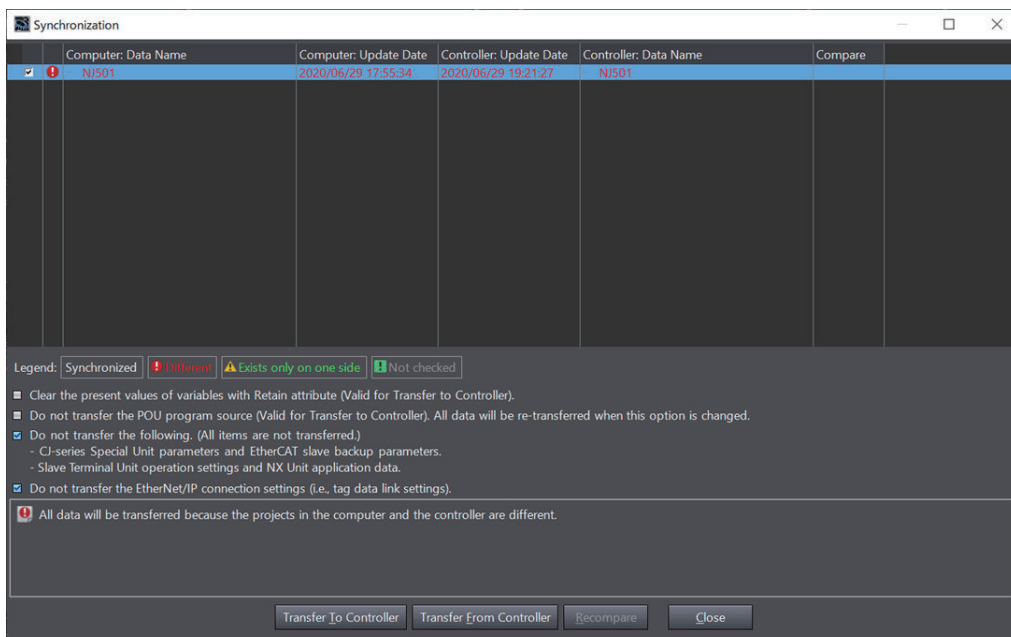



2 Click the **Transfer to Controller** button.

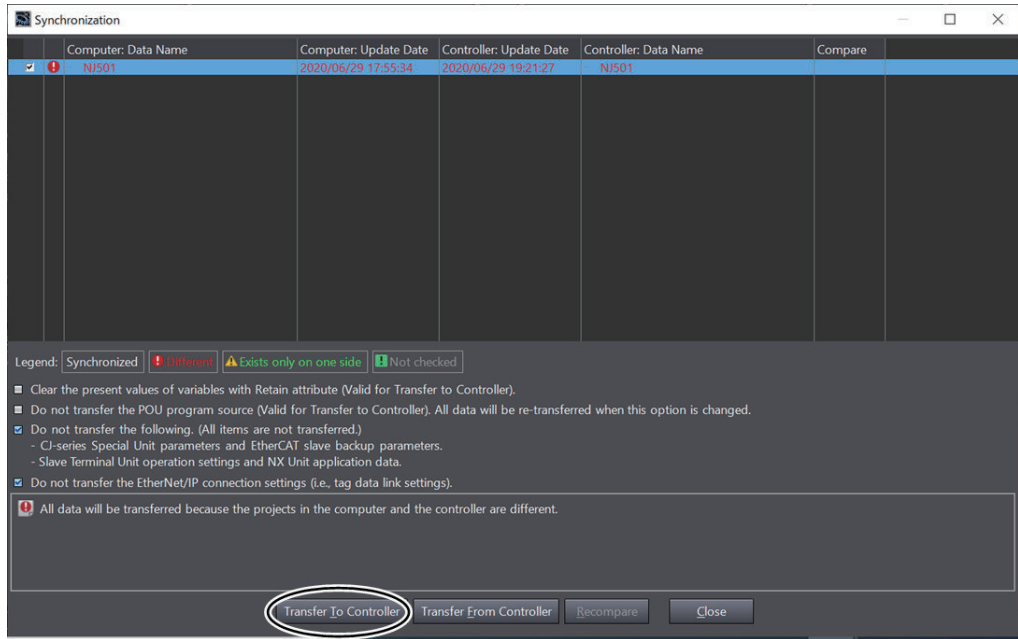

3 Confirm that "The Synchronization process successfully finished." is displayed, and then click the **Close** button.

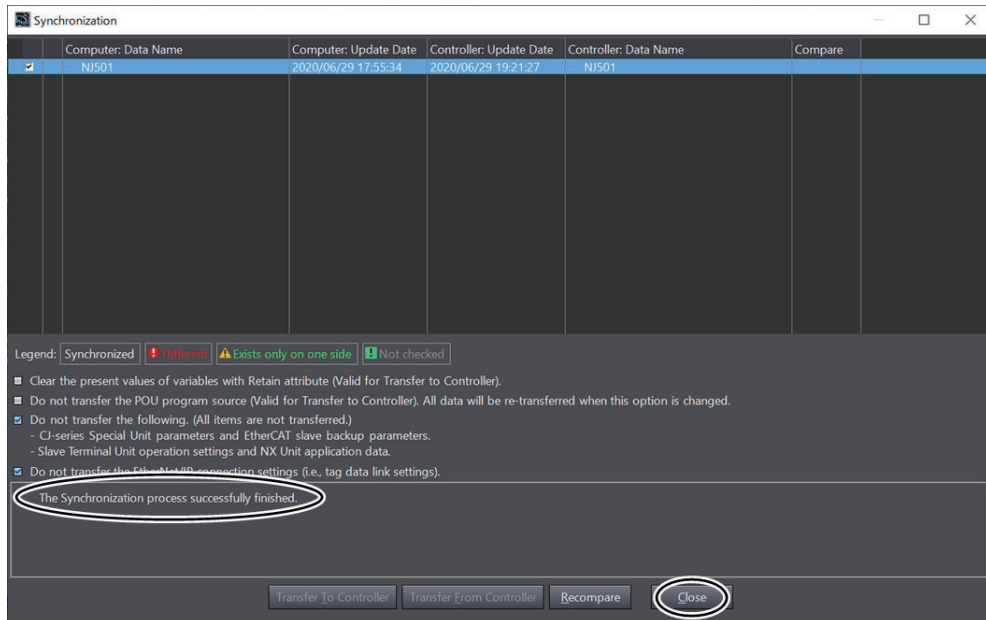

4 Confirm that the Robot Integrated CPU Unit is turned ON normally. The status of indicators for normal operation is given below.

Indicators	Status
RUN indicator	Lit green

Indicators	Status
ERROR indicator	Not lit
NET RUN	Lit green
NET ERR	Not lit
LINK/ACT	Flashing

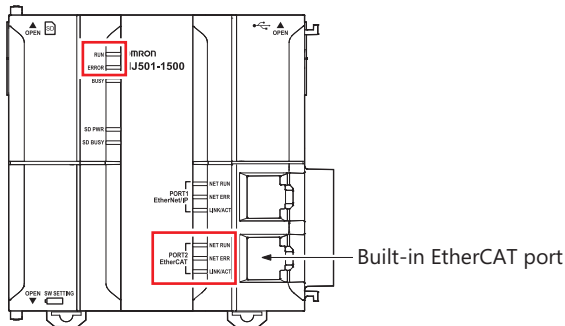

- 5** Confirm that the robot is turned ON normally.  
The status of indicators for normal operation is given below.

Indicators	Status
RUN indicator	Lit green
ERR indicator	Not lit

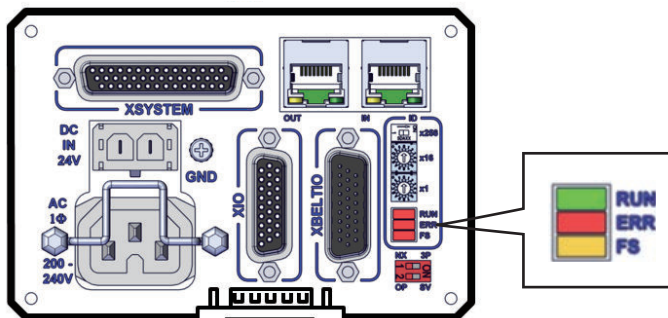

### 3-5-3 Teaching

A robot is operated actually to check and correct teaching data.  
Move the robot to the teaching position set in the simulation operation actually, and adjust the position if necessary. The teaching position data is saved in the SD Memory Card so that the data is retained after the power supply to the Robot Integrated CPU Unit is turned OFF.  
The T20 pendant is used for teaching. Refer to the *Teaching Pendant T20 User's Manual (Cat. No. 1601)* for information on the specifications of the T20 pendant.  
Place a workpiece where you plan to pick it up before performing the teaching operation.

## Turning Robot High Power ON

The robot high power is turned ON.

- 1** Change the operating mode switch on the front panel to Manual Mode.

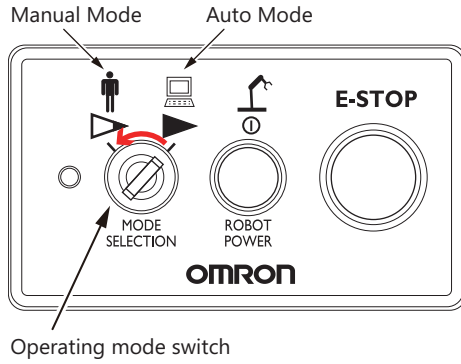

- 2 Press the enable switch on the T20 pendant to Position 2 (half-way).



- 3 Press the Robot Power button while the enable switch is kept in Position 2 (half-way).



The Robot Power button on the front panel flashes.

- 4 Press the Robot Power button on the front panel.  
The robot high power is turned ON and the Robot Power button is lit.

If you release the enable switch (Position 1) or press the enable switch further from Position 2 (half-way) to Position 3, the robot high power will be turned OFF.

**Precautions for Correct Use**

If it is necessary to move the robot, follow the procedure above to turn ON the high power.

**Adjusting Teaching Position in Simulation Operation**

The teaching position that is set in setup procedure with the simulation operation is adjusted to match the actual place position. The robot actually moves to the teaching position set in the simulation operation, and correct the position if there are differences between teaching position and expected position. Use the following procedure to adjust position according to the travel route of the robot. You must adjust the wait position and approach position more than once.

Position name (Variable name)	Description	Order of adjustment
gl.wait	Robot wait position	1, 4
gl.pick	Workpiece pick-up position	2
gl.place	Workpiece place position	3

**Precautions for Correct Use**

Perform the adjustment in the above order in the table. If the adjustment is performed in different order, the robot may move to the unintended travel route and contact to the equipments such as a conveyor, and then the devices may be damaged.

- 1 Confirm that the T20 pendant displays the **HOME1** screen.

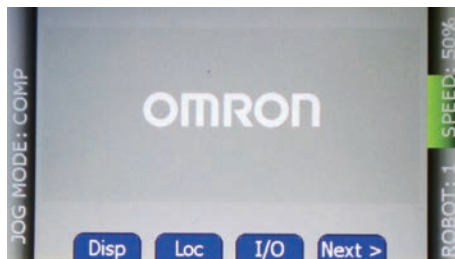

- 2 Press the F4 button (Next>) twice.



The **HOME3** screen is displayed.



**3** Press the F1 button (Maint).



The **SYSTEM MAINTENANCE** screen is displayed.

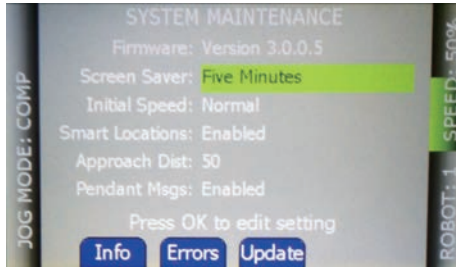

- 4 Press the up or down arrow button to select **Approach Dist** field.

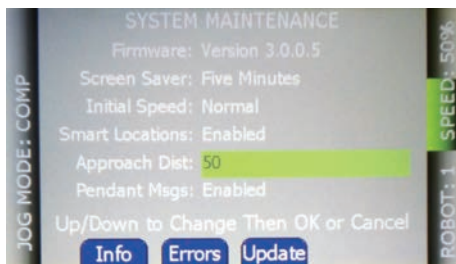

- 5 Press the OK button.



- 6 Press the up or down arrow button to change the value of **Approach Dist** field. You can select the height to rise and fall in the range of 1 to 200 mm.



Assume that the value of height to rise and fall is 40 in this step.

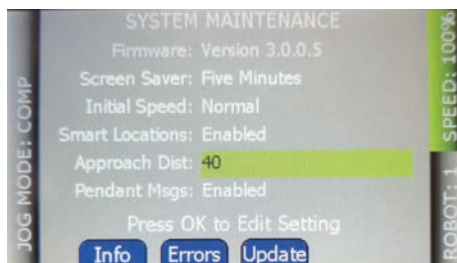

- 7 Press the OK button.



8 Press the MENU button to back to **HOME1** screen.



9 Press the F2 button (Loc).



The **AVAILABLE LOCATIONS** screen is displayed.





- 10** On the **AVAILABLE LOCATIONS** screen, use the arrow buttons to select the teaching position from the list of locations.



- 11** Press the F4 button (Next>).



The display for the soft keys changes on the bottom of the screen.

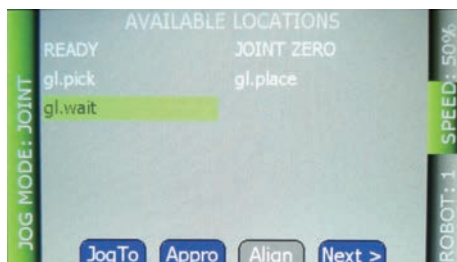

- 12** If the variable selected in step 10 is *gl.pick* or *gl.place*, press and hold the F2 button (Appro).



The robot moves linearly to the top of the selected position.

**13** Press and hold the F1 button (JogTo).



The robot moves linearly to the selected position.

**14** When the robot moves to the selected position, release the F1 button (JogTo).

If there is no problem with the position and posture after the move, proceed to step 20. If you adjust the position and posture, perform step 15 and later.

**15** Press the F4 button (Next>) and then F2 button (Teach).



The **TEACH** screen for the selected location is displayed.

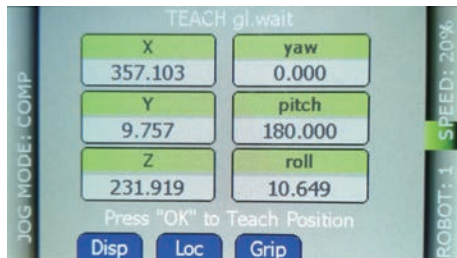

- 16** Press the Jog Mode button until the desired mode is displayed in the Jog Mode Indicator area. Assumes that the adjustment of the position in World Mode is performed in this step, and press the button until **WORLD** is displayed.

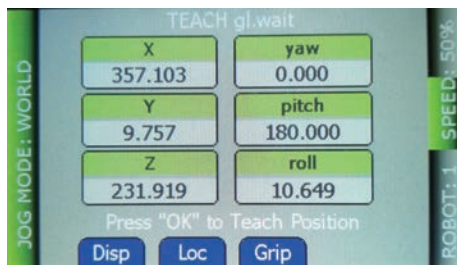

- 17** Press the JOINT/AXIS CONTROL button to move the robot to the desired position and posture.

The following table shows the relationship between coordinate axes in World Mode and JOINT/AXIS CONTROL button.

Letter	Description	JOINT/AXIS CONTROL button
A	+X (X direction)	X
B	+Y (Y direction)	Y
C	+Z (Z direction)	Z
D	+RZ, CCW (RZ rotation)	RZ

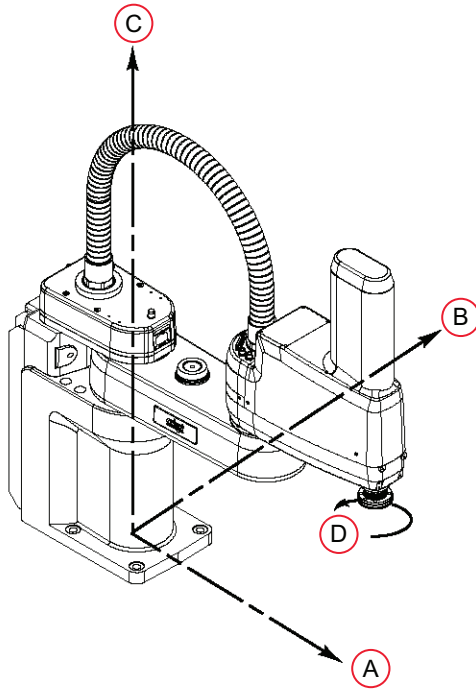

**18** Press the OK button.



The value of position is updated to the current robot position.

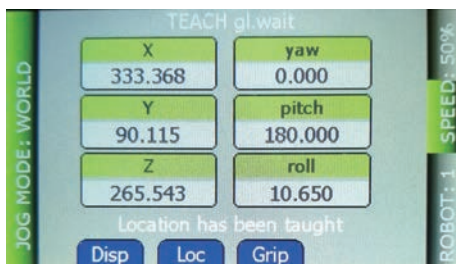

**19** Press the F2 (Loc) button and then F4 button (Next>).  
The **AVAILABLE LOCATIONS** screen is displayed again.



- 20** If the variable selected in step 10 is *gl.pick* or *gl.place*, press and hold the F2 button (Appro).



The robot moves linearly to the top of the selected position.

- 21** If there are still positions left to adjust, return to step 10.

## Saving Teaching Position in SD Memory Card

The teaching position data is saved in the SD Memory Card so that the data is retained after the power supply to the Robot Integrated CPU Unit is turned OFF.



### Precautions for Correct Use

If the power supply to the Robot Integrated CPU Unit turned OFF without saving position data in the SD Memory Card, the adjusted position data is lost, and then the robot may perform unintended operations the next time that the CPU Unit is started. Perform this procedure if you perform teaching on the actual system.

- 1** Click **RobotControlSettings** from the device list in the Multiview Explorer of the Sysmac Studio.

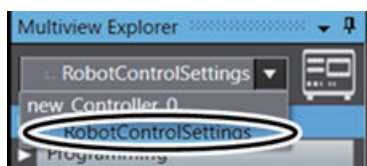

- Click the **Pull from V+ Memory** icon in the toolbar of the Multiview Explorer.



- Select **Configurations and Setup - Save Configuration** in the Multiview Explorer.

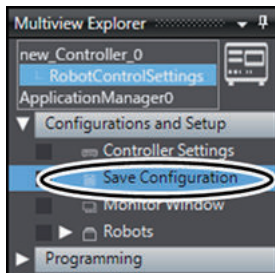

- Click the **Save To Controller** button in the **Save Configuration** tab page.

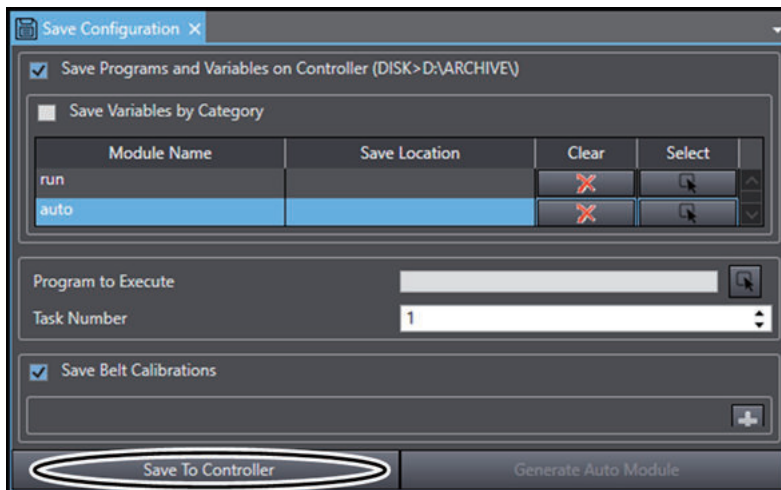

- Click **File - Save** from the menu bar.



#### 3-5-4 Executing Program to Check Operation

The robot operation before the automatic operation is checked according to the program.

- Change the operating mode switch on the front panel to Auto Mode.

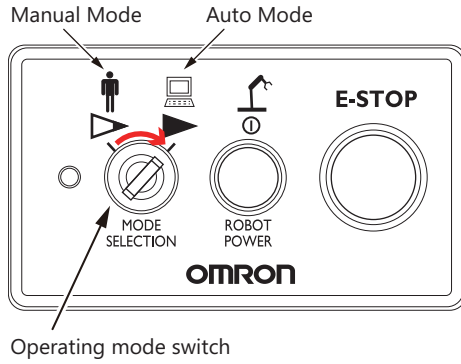

**2** Press the Robot Power button on the front panel.

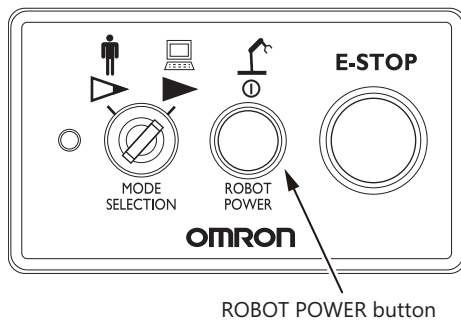

The Robot Power button flashes. Press the Robot Power button again. Then, the Robot Power button lights up and the robot high power turns ON.

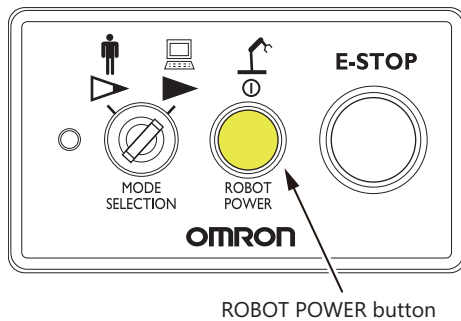

**3** Select **View - Watch Tab Page** from the menu bar in the main window of the Sysmac Studio on the computer.

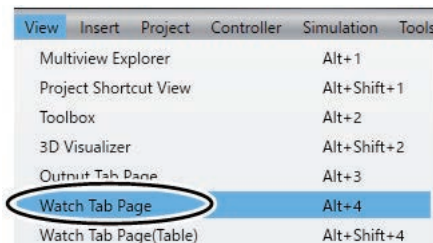

The **Watch** tab page is displayed under the main window.

Device name	Name	Online value	Modify	Comment	Data type
new_Controller_0	gStart			Auto-operation start button	BOOL
new_Controller_0	Input Name...				

- 4 Click the **TRUE** button in the **Modify** column for **gStart**.

Device name	Name	Online value	Modify	Comment	Data type
new_Controller_0	gStart	False	TRUE FALSE	Auto-run start button	BOOL
new_Controller_0	Input Name...				

The robot performs pick-and-place operation according to the program.

If you use this program actually, write a program so that you can operate *gStart* variable from the HMI.



#### Precautions for Correct Use

If the operation is controlled with the V+ program and the operating mode of the Robot Integrated CPU Unit is switched from RUN mode to PROGRAM mode, and then to RUN mode again, press the Robot Power button on the front panel to make sure that the light of the button is OFF, and then press the button again to confirm that it is lit before executing the above procedure.



# 4

## Implementation Example of Dynamic Pick-and-place Equipment

This section describes the implementation example of the dynamic pick-and-place equipment.

4

<b>4-1</b>	<b>Program Specifications for Dynamic Pick-and-place Equipment</b> .....	<b>4-3</b>
4-1-1	Program Structure .....	4-3
<b>4-2</b>	<b>Basic Startup Procedures</b> .....	<b>4-12</b>
<b>4-3</b>	<b>Programming and Simulation Procedures</b> .....	<b>4-15</b>
4-3-1	Creating a Project File .....	4-15
4-3-2	Creating the EtherCAT Network Configuration .....	4-16
4-3-3	Creating V+ Programs .....	4-19
4-3-4	Writing a Sequence Control Program .....	4-23
4-3-5	Placing 3D Shape Data .....	4-30
4-3-6	Creating a Pack Manager Sample .....	4-53
4-3-7	Creating C# Programs .....	4-81
4-3-8	Setting up Automatic Loading of V+ Programs and Variables at Power ON ..	4-83
4-3-9	Executing Program to Check Operation .....	4-87
<b>4-4</b>	<b>Installing and Wiring the System</b> .....	<b>4-93</b>
4-4-1	Wiring the Robot Integrated CPU Unit and the EtherCAT Digital I/O Terminal .....	4-94
4-4-2	Setting the Node Address of the EtherCAT Digital I/O Terminal .....	4-94
4-4-3	Wiring the EtherCAT Digital I/O Terminal and Inverter's EtherCAT Communications Unit .....	4-95
4-4-4	Setting the Node Address of Inverter's EtherCAT Communications Unit .....	4-95
4-4-5	Wiring the Inverter's EtherCAT Communications Unit and Robot .....	4-95
4-4-6	Setting the EtherCAT Node Address of the Robot .....	4-96
4-4-7	Wiring the Robot, T20 Pendant and the Front Panel .....	4-96
4-4-8	Wiring the Robot and Encoder .....	4-98
4-4-9	Wiring the EtherNet/IP Port on the Robot Integrated CPU Unit .....	4-99
4-4-10	Wiring Between the IPC Application Controller, Display, and Camera .....	4-100
4-4-11	Wiring the Camera and Robot .....	4-100
4-4-12	Wiring the EtherCAT Digital I/O Terminal and Solenoid Valve .....	4-101
<b>4-5</b>	<b>Operation Check on the Actual System</b> .....	<b>4-103</b>
4-5-1	Communications Setup .....	4-103
4-5-2	Online Connection .....	4-110
4-5-3	Transferring Settings and Programs .....	4-111
4-5-4	Setting up the Camera .....	4-115
4-5-5	Running a Sequence Control Program and V+ Program .....	4-126
4-5-6	Turning Robot High Power ON .....	4-128
4-5-7	Calibrating the Belt .....	4-130
4-5-8	Calibrating the Sensor .....	4-135

4-5-9	Setting the Locator .....	4-146
4-5-10	Teaching Idle, Pick, and Place Positions .....	4-151
4-5-11	Running the Program to Check the Operation .....	4-154

# 4-1 Program Specifications for Dynamic Pick-and-place Equipment

This section describes the program specifications to control the dynamic pick-and-place equipment. For information on how to create a program, refer to 4-3 *Programming and Simulation Procedures* on page 4-15.

## 4-1-1 Program Structure

This section describes the specifications of the program to control the dynamic pick-and-place equipment.

The program consists of the following programs.

Program Name	Language	Description
Main	Sequence control program (Ladder diagram)	Main program
ConveyerControl	Sequence control program (Ladder diagram)	Operating program for the conveyor
RobotControl	Sequence control program (Ladder diagram)	Program for automatic operation of the robot
px.start	V+ program	A program to call C# program for starting
px.stop	V+ program	A program to call C# program for stopping
supervisor	V+ program	Status monitoring program for the robot
control	V+ program	Regular processing program for the robot operation
auto	V+ program	Startup processing program for the robot operation
PM_Start	C# program	Startup program of the Process Manager
PM_Stop	C# program	Stop program of the Process Manager

The role of each program and peripheral devices are as follows.

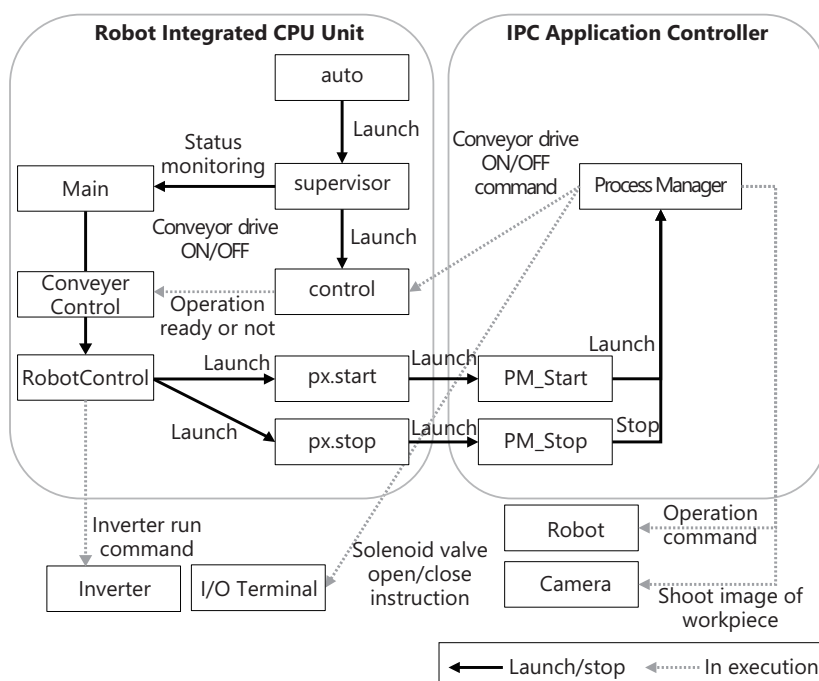

In this equipment, Pack Manager sample is used to program the pick-and-place operation.

If you use the Pack Manager sample, you can operate the robot by using the Process Manager function of the IPC Application Controller. It eliminates the need to create complex programs for processing to work with peripheral devices. However, you need to make the V+ programs and C# programs to start or stop the Process Manager.

Process Manager can be started or stopped by calling the C# program, which is executed by the IPC Application Controller, from the V+ program that is running on the Robot Integrated CPU Unit.

Process Manager's solenoid valve opening/closing instruction is written to outputs of V+ Digital I/O.

They are assigned to the contacts of the EtherCAT I/O Slave by the V+ Digital I/O Settings function and are output from those contacts.

Process Manager's conveyor drive ON/OFF instruction is written to the output of V+ Digital I/O. The V+ program for regular processing, "control", polls for the status of the conveyor drive ON/OFF instruction and writes it to the shared variable. In addition, the sequence control program "ConveyerControl" polls for the shared variables, converts them to operational instructions (ON/OFF instructions, velocity command, and rotational directions), and outputs them to the inverter.

### Sequence Control Program

This section describes the sequence control program to control the dynamic pick-and-place equipment.

In the sequence control program, register global variables and create three programs, "Main" (main program), "ConveyerControl", and "RobotControl".

#### ● Global Variables

Register the global variables that are used in the sequence control program.

The following variables are automatically generated in the I/O Map tab page.

Name	Data type	Comment
E002_Command	WORD	Inverter run command
E002_Frequency_reference	UINT	Inverter target frequency
E002_Status	WORD	Inverter status
E002_Output_frequency_monitor	UINT	Inverter frequency monitor
E002_Sysmac_Error_Status	BYTE	Inverter Sysmac error

Register the variables below yourself.

Name	Data type	Comment
e_conveyor_dir	BOOL	Conveyor reverse command
e_conveyor_run	BOOL	Conveyor run command
e_conveyor_spd	BOOL	Conveyor fast run command
e_is_run_mode	BOOL	Operation mode
gRC_Err	BOOL	Robot control error
gReset	BOOL	Auto-operation stopped
gStart	BOOL	Auto-operation started
gSysOK	BOOL	Operation ready
eBool_exeT1	BOOL	supervisor in execution
gEnableT1	BOOL	supervisor executable

The following variables are automatically generated when a robot is added to the system configuration.

Name	Data type	Comment
RC_Robot001	_sRC_RBT_REF	iX4 650H
RC_Robot001_IO	_sRC_RBT_IO_REF	iX4 650H I/O

● **Main program (Main)**

"Main" (main program) is used to monitor the status of the robot and judge whether the automatic operation can start.

An example of a program is provided below.

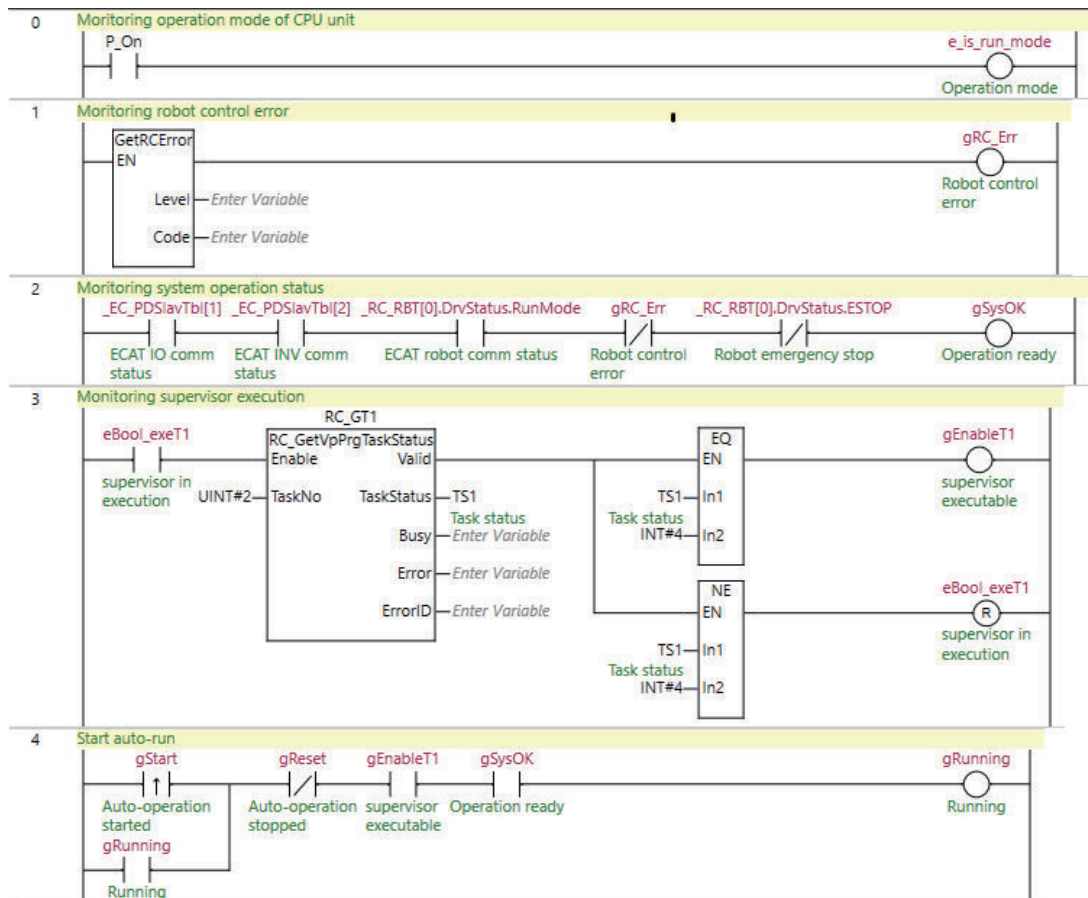

● **Operating Program (ConveyerControl)**

"ConveyerControl" (operating program) makes the inverter start running on receiving a command. During automatic operation, the ON/OFF command is sent to the Inverter according to the conveyer drive ON/OFF instruction from the Process Manager.

An example of a program is provided below.

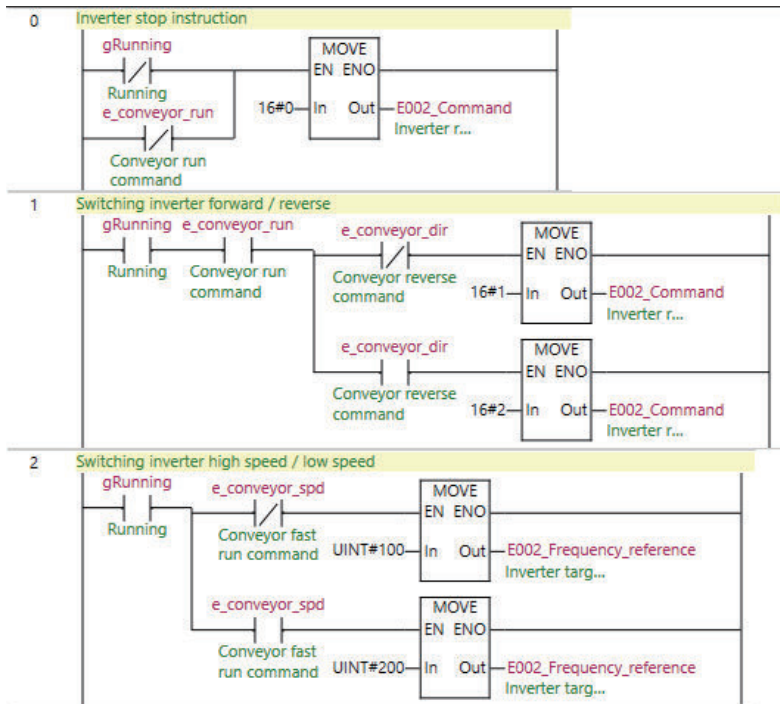

### ● Operating Program (RobotControl)

"RobotControl" (operating program) runs automatically on receiving a command.

An example of a program is provided below.

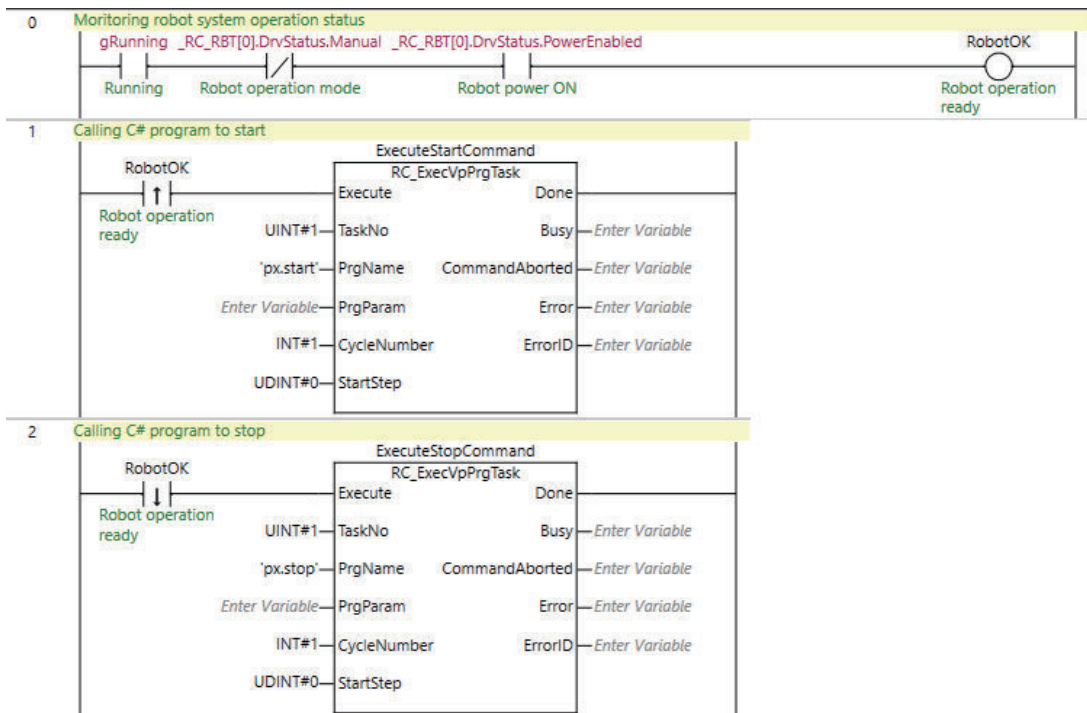

## V+ Program

This section describes the V+ program to control the dynamic pick-and-place equipment.

In this section, you create five V+ programs: "px.start" to call the C# program for starting the Process Manager, "px.stop" to call the C# program for stopping the Process Manager, the status monitoring program "supervisor", the regular processing program "control", and the startup processing program "auto".

### ● V+Digital I/O

Communications between multiple V+ programs or between V+ programs and external EtherCAT Digital I/O Terminals are performed via V+ Digital I/Os.

The I/O number to be used is shown below. Set No.4001 from the V+Digital I/O Settings.

Range	Number	Applications
1-96	Outputs	Not used
1001-1096	Inputs	1001 Latch number
2001-2999	Soft Signals	2001 Run the belt conveyor
		2002 Switch fast/slow control of the belt conveyor
		2003 Run the belt conveyor backward
3001-3004	Robot Signals	Not used
4001-4032	External	4001 Solenoid valve open (GX-MD3218 OUT0)

### ● Program to Call C# Program for Starting (px.start)

This section describes the program to call the C# programs for starting the Process Manager. An example of a program is provided below.



#### Additional Information

You cannot use the program with Sysmac Studio version 1.42. Use the program with Sysmac Studio version 1.43 or higher.

On Sysmac Studio ver.1.42, go online with the IPC Application Controller, select **ApplicationManager1 - C# Program - PM\_Start** and click the **Start** button on the **Task Status Control** pane.

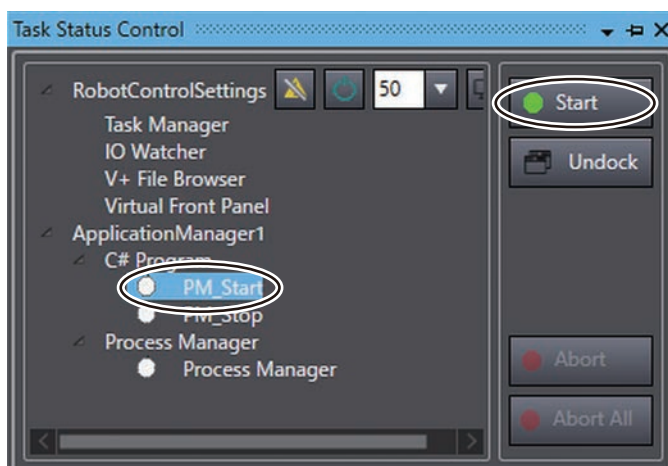

```
.PROGRAM px.start()
  GLOBAL $ip
  AUTO REAL status
  TYPE "Start PM_Start"
```

```

CALL rm.execute3($ip, "/ApplicationManager1/PM_Start", "Execute", 0, $arg
s[], 3, status)
IF status < 0 THEN
    TYPE "Failed to execute: error code ", status
END
.END

```

### ● Program to Call C# Program for Stopping (px.stop)

This section describes the program to call the C# program for stopping the Process Manager. An example of a program is provided below.



#### Additional Information

You cannot use the program with Sysmac Studio version 1.42. Use the program with Sysmac Studio version 1.43 or higher.

On Sysmac Studio ver.1.42, go online with the IPC Application Controller, select **ApplicationManager1 - C# Program - PM\_Stop** and click the **Start** button on the **Task Status Control** pane.

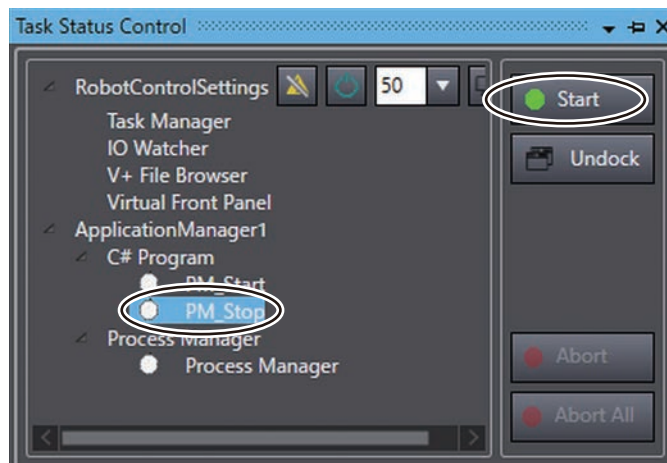

```

.PROGRAM px.stop()
    GLOBAL $ip
    AUTO REAL status
    TYPE "Start PM_Stop"
    CALL rm.execute3($ip, "/ApplicationManager1/PM_Stop", "Execute", 0, $arg
s[], 3, status)
    IF status < 0 THEN
        TYPE "Failed to execute: error code ", status
    END
.END

```

### ● Status Monitoring Program (supervisor)

The status monitoring program (supervisor) monitors the regular processing program "control" to ensure that the program does not stop abnormally while the sequence control is in RUN mode. When it detects sequence control going into PROGRAM mode, it stops the regular processing control program "control" and the Application Manager.



An example of a program is provided below.

The variable ebool\_exet1 is a flag that indicates that the V+ program is executable. The sequence control program monitors the status of this variable, and starts automatic operation when the V+ program is ready to run.

```
.PROGRAM supervisor()
    EXTERNAL e_is_run_mode, ebool_exet1
    AUTO REAL p_is_run_mode
    GLOBAL $ip
    $ip = "127.0.0.1"
    p_is_run_mode = e_is_run_mode
    WHILE TRUE DO
        IF e_is_run_mode THEN
            IF TASK(1,3) <> 4 THEN
                EXECUTE 3 control()
            END
            ebool_exet1 = TRUE
        ELSE
            IF TASK(1,3) <> 0 THEN
                ABORT 3
                CYCLE.END 3
                KILL 3
            END
            IF p_is_run_mode THEN
                BRAKE
                CALL px.stop()
            END
        END
        p_is_run_mode = e_is_run_mode
        WAIT
    END
.END
```

### ● Regular Processing Program (control)

Regular processing program is a program that performs a routine processing. If it fails to start, it automatically restarts. The routine processing includes the process of writing values of V+ digital I/O signals to the shared variables with the sequence control program.

A program is described below.

```
.PROGRAM control()
    EXTERNAL e_conveyor_run
    EXTERNAL e_conveyor_spd
    EXTERNAL e_conveyor_dir
    WHILE TRUE DO
        e_conveyor_run = SIG(2001)
        e_conveyor_spd = SIG(2002)
        e_conveyor_dir = SIG(2003)
    END
```

```

        RELEASE
    END
.END

```

### ● Startup Processing Program (auto)

The startup processing program, auto, reads the V+ programs and global variables from the SD Memory Card to the main memory and starts the status monitoring program.

Since this program is automatically generated, you don't need to write a program.

## C# Programs

This section describes the C# programs to control the dynamic pick-and-place equipment.

### ● Startup Program of Process Manager (PM\_Start)

This program launches the Process Manager.

An example of a program is provided below.

```

using Ace.Server.Xpert.PackXpert;
using Ace.Services.NameLookup;
using Ace.Client.ApplicationManager.AutoConnect;
using Ace.Server;
using System;
using System.Collections.Generic;
using System.Diagnostics;

namespace Ace.Custom {
    public class Program {
        public INameLookupService ace;
        public void Main() {
            Trace.WriteLine("Script Starting");
            IProcessManager processManager = (IProcessManager) ace[
                "/ApplicationManager1/Process Manager"];
            processManager.Start();
        }
    }
}

```

### ● Stop Program of Process Manager (PM\_Stop)

This program stops the Process Manager..

An example of a program is provided below.

```

using Ace.Server.Xpert.PackXpert;
using Ace.Services.NameLookup;
using Ace.Client.ApplicationManager.AutoConnect;
using Ace.Server;
using System;
using System.Collections.Generic;

```

```

using System.Diagnostics;

namespace Ace.Custom {
    public class Program {
        public INameLookupService ace;
        public void Main() {
            Trace.WriteLine("Script Starting");
            IProcessManager processManager = (IProcessManager) ace[
                "/ApplicationManager1/Process Manager"];
            processManager.Stop();
        }
    }
}

```



#### Precautions for Correct Use

The contents of the text string "/ApplicationManager1/Process Manager" in each C# program differ depending on the language used when you created the project file. Select **ApplicationManager1** from the device list in the **Multiview Explorer** and select **Configurations and Setup - Process - Process Manager**. Drag and drop it onto the C# editor, and an appropriate text string is automatically selected.

## 4-2 Basic Startup Procedures

This section gives an overview of the basic startup procedures to build a dynamic pick-and-place system.

First, program a machine operation, configure and check the settings using the simulator, and then run the system for fine-tuning the operation.

No.	Procedure	Description	Reference	
1	Programming and Simulation Procedures	Creating a project	Create a project file in the Sysmac Studio.	page 4-15
2		Creating the network configuration	Create the EtherCAT network configuration and register an EtherCAT Digital I/O Terminal, an inverter, and a robot on the network.	page 4-16
3		Writing V+ programs	Create the V+ programs.	page 4-19
4		Writing a sequence control program	Create a sequences control program.	page 4-23
5		Placing 3D shape data	Place 3D shape data and make the operating range of the robot visible on the 3D Visualizer.	page 4-30
6		Creating a Pack Manager sample	Configure the robot settings, camera settings, and conveyor settings by using the simulation function and perform teaching.	page 4-53
7		Writing C# programs	Create the C# programs.	page 4-81
8		Running the program (Simulation)	Run the sequence control program on the simulator of the Sysmac Studio.	page 4-87

No.	Procedure	Description	Reference	
9	Installing and Wiring the System	Wiring the Robot Integrated CPU Unit and EtherCAT Digital I/O Terminal	Wire the Robot Integrated CPU Unit and the EtherCAT Digital I/O Terminal.	page 4-94
10		Setting the node address of the EtherCAT Digital I/O Terminal	Set the EtherCAT node address of the EtherCAT Digital I/O Terminal.	page 4-94
11		Wiring the EtherCAT Digital I/O Terminal and Inverter's EtherCAT communications unit	Wire the EtherCAT Digital I/O Terminal and the EtherCAT communications unit of the Inverter.	page 4-95
12		Setting the node address of the Inverter's EtherCAT communications unit	Set the EtherCAT node address of the EtherCAT communications unit of the Inverter.	page 4-95
13		Wiring the Inverter's EtherCAT communications unit and robot	Wire the EtherCAT communications unit of the Inverter and the robot	page 4-95
14		Setting the EtherCAT node address of the robot	Set the EtherCAT node address of the robot.	page 4-96
15		Wiring the robot, T20 pendant, and front panel	Wire the robot and the T20 pendant, as well as the robot and the front panel. Use an XSYSTEM cable assembly, a T20 adapter cable, and a front panel cable for wiring.	page 4-96
16		Wiring the robot and encoder	Wire the robot and the encoder.	page 4-98
17		Wiring the EtherNet/IP Port on the Robot Integrated CPU Unit	Wire between the Robot Integrated CPU Unit and the industrial Ethernet switch, between the industrial Ethernet switch and the computer, and between the industrial Ethernet switch and the IPC Application Controller.	page 4-99
18		Wiring the IPC Application Controller and display and camera	Wire between the IPC Application Controller and the display, and between the IPC Application Controller and the camera.	page 4-100
19		Wiring the camera and robot	Wire the camera and the robot.	page 4-100
20		Wiring the EtherCAT Digital I/O Terminal and solenoid valves	Wire the EtherCAT Digital I/O Terminal and the solenoid valves.	page 4-101

No.	Procedure	Description	Reference	
21	Operation Check on the Actual System	Communication settings	Configure the communication settings for connecting Sysmac Studio on the computer and the devices.	page 4-103
22		Going online	Connect Sysmac Studio online with the Robot Integrated CPU Unit.	page 4-110
23		Transferring settings and programs	Download the programs and settings in the Sysmac Studio project file to the Robot Integrated CPU Unit and the IPC Application Controller.	page 4-111
24		Camera settings	Set the properties of the camera.	page 4-115
25		Running the sequence control program and V+ program	Run the sequence control program and V+ programs.	<i>4-5-5 Running a Sequence Control Program and V+ Program</i> on page 4-126
26		Turning robot high power ON	Turn ON the robot high power.	<i>Turning Robot High Power ON</i> on page 3-96
27		Calibrating the belt	Perform belt calibration.	<i>4-5-7 Calibrating the Belt</i> on page 4-130
28		Sensor calibrations	Calibrate the sensor.	<i>4-5-8 Calibrating the Sensor</i> on page 4-135
29		Setting the Locator	Set the Locator.	<i>4-5-9 Setting the Locator</i> on page 4-146
30		Teaching idle, pick, and place positions (On actual equipment)	Operate the robot actually to check and correct teaching data.	page 4-151
31		Running the programs (On actual equipment)	Check the operation of the system before starting the automatic operation.	page 4-154

## 4-3 Programming and Simulation Procedures

This section describes the procedure for creating project files, programming, and setting and checking operation in simulation.

The simulation function allows you to check the equipment operation before purchasing actual equipment.

### 4-3-1 Creating a Project File

Create a project in the Sysmac Studio.

- 1 Start the Sysmac Studio and click **New Project** in the Start page.

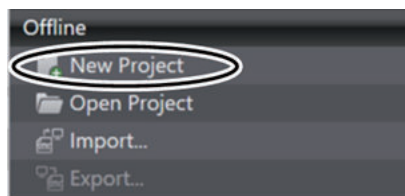

The **Project Properties** dialog box is displayed.

- 2 In the **Project Properties** dialog box, enter the **Project name**, **Author**, and **Comment**, and select the **Category**, **Device**, and **Version** as shown in the figure below.

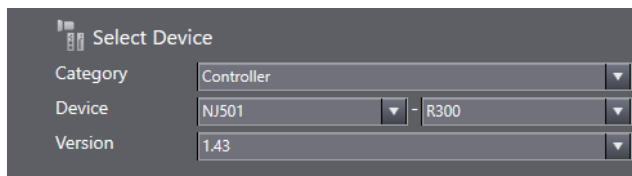

- 3 Select the **Open in Emulation Mode** check box, and click the **Create** button.

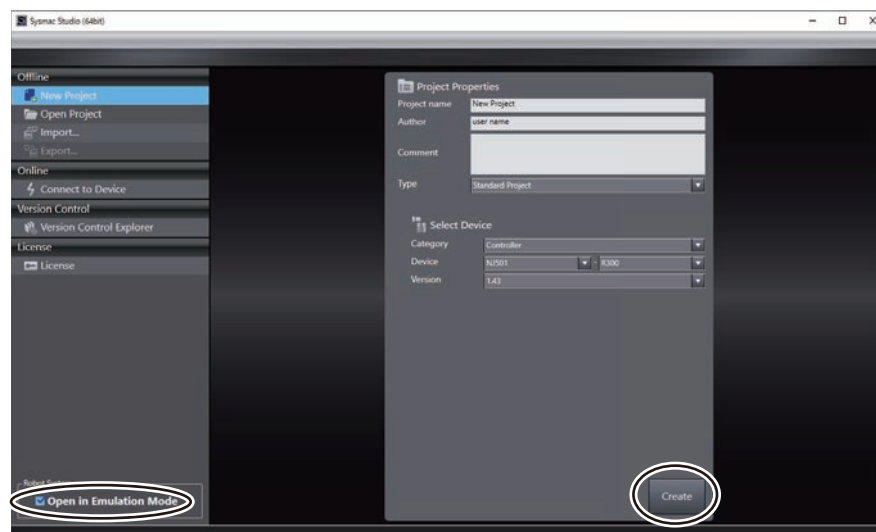

A project file is created and the following window is displayed.

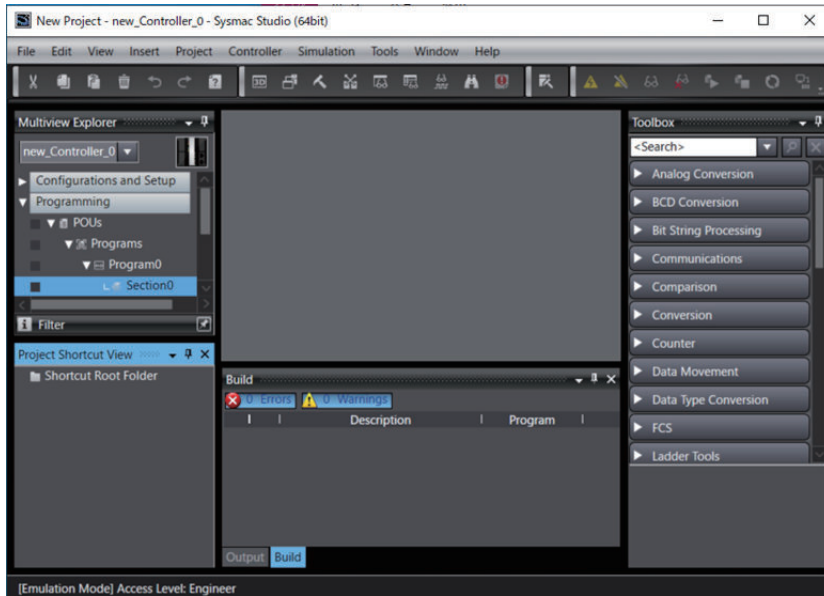

### 4-3-2 Creating the EtherCAT Network Configuration

Create the EtherCAT network configuration and register an EtherCAT Digital I/O Terminal, an inverter, and a robot on the network.

- 1 Click **Configurations and Setup** in the Multiview Explorer.

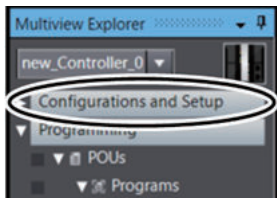

Setting items are displayed under **Configurations and Setup** in the tree.

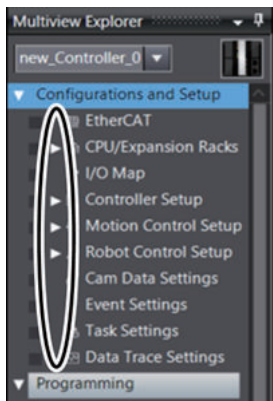

- 2 Double-click **EtherCAT** under **Configurations and Setup** in the Multiview Explorer. Or right-click **EtherCAT** under **Configurations and Setup** and select **Edit** from the menu.



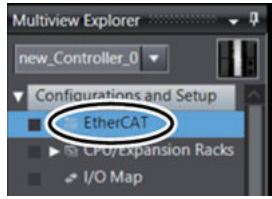

The EtherCAT Master is displayed in the EtherCAT tab page.

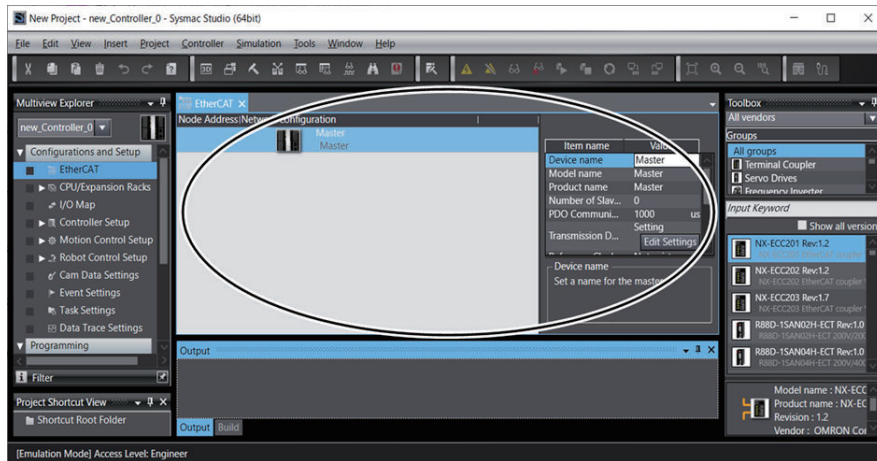

- From the **Toolbox**, select the group of **Digital IO**.

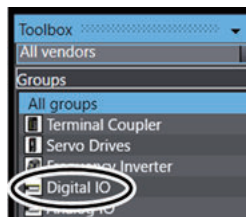

- Click and drag the digital I/O to use and drop it on the EtherCAT Master in the EtherCAT tab page. In this example, select **GX-MD3218**.

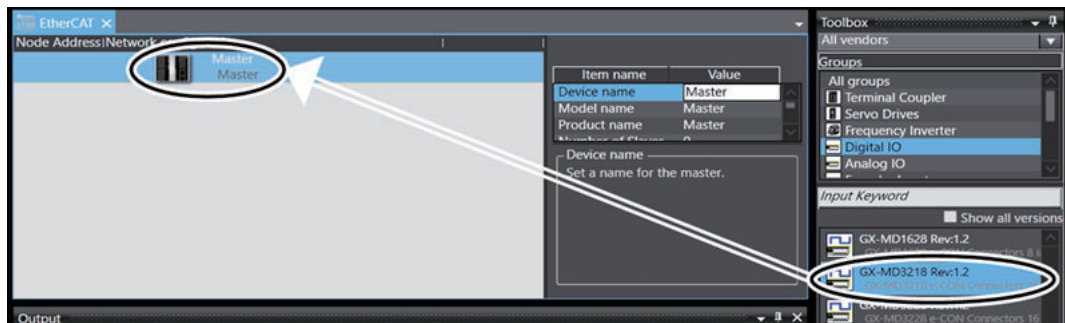

A **GX-MD3218** is registered under the EtherCAT Master.

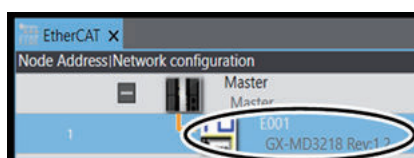

- 5 From the **Toolbox**, select the group of **Frequency Inverter**.

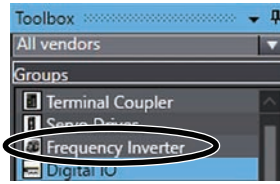

- 6 Select and drag the inverter to use and drop it on the **GX-MD3218** in the EtherCAT tab page. In this example, select **3G3AX-MX2-ECT**.

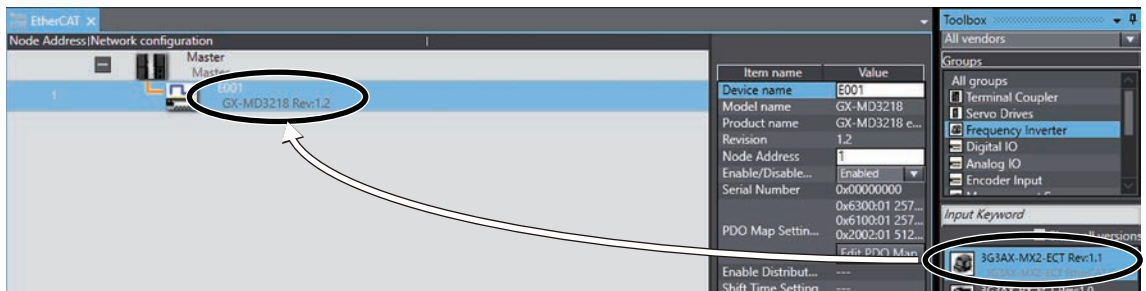

A **3G3AX-MX2-ECT** is added under the **GX-MD3218**.

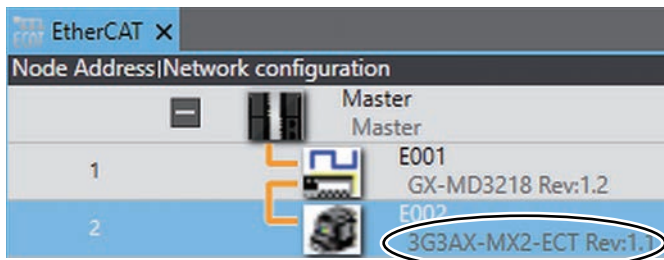

- 7 From the **Toolbox**, select the group of **Robot**.

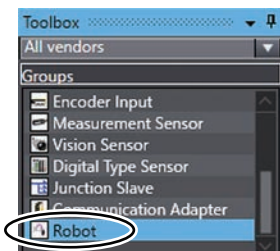

- 8 Select and drag the robot to use and drop it on the **3G3AX-MX2-ECT** in the EtherCAT tab page. In this example, **ix4 650H, IP65, P30** is selected.

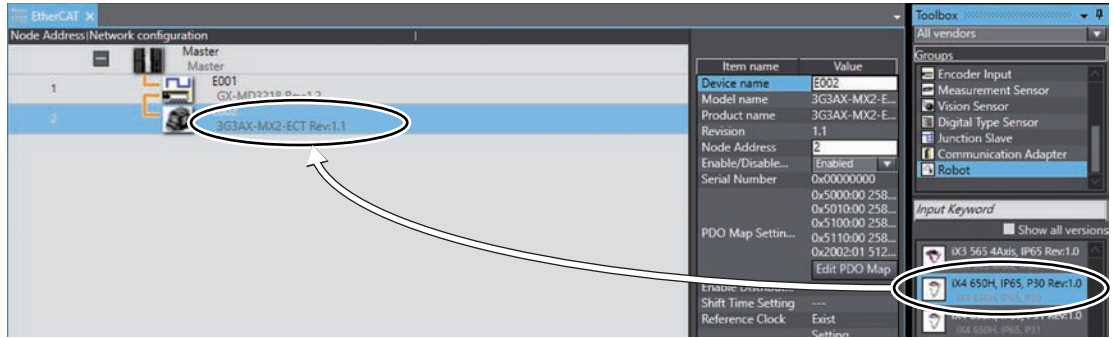

An **iX4 650H, IP65, P30** is added under the **3G3AX-MX2-ECT** in the **EtherCAT** tab page.

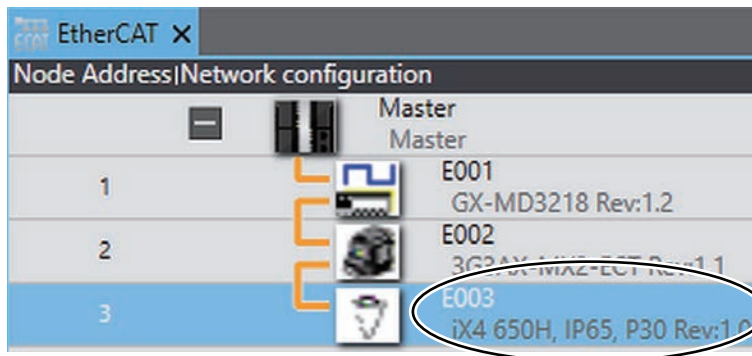

### 4-3-3 Creating V+ Programs

This section provides the procedure for creating the V+ programs.

For details on the program to create and allocation of V+ digital I/Os, refer to *V+ Program* on page 4-6.

## V+Digital I/O Settings

To control EtherCAT Slaves by V+ programs, you must assign V+ digital I/Os.

- 1 In the Multiview Explorer, select **new\_Controller\_0** from the device list.

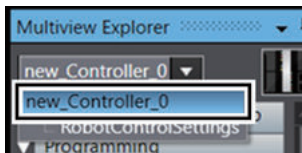

- 2 Click the  icon to the left of **Robot Control Setup** in the Multiview Explorer.

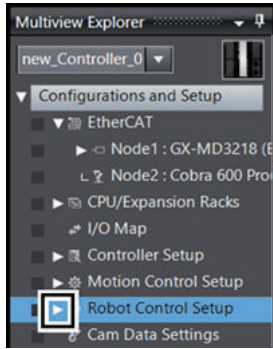

The setting items are displayed in the tree view as shown below.

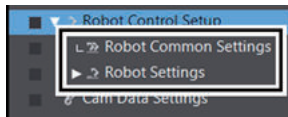

### 3 Double-click **Robot Common Settings**.

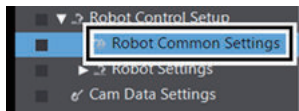

The **Robot Common Settings** tab page is displayed.

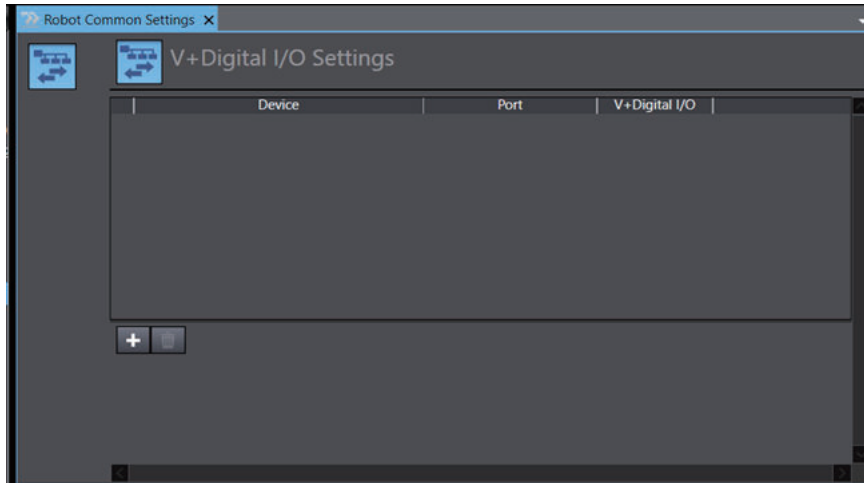

### 4 Click the + button in the **Robot Common Settings** tab page.

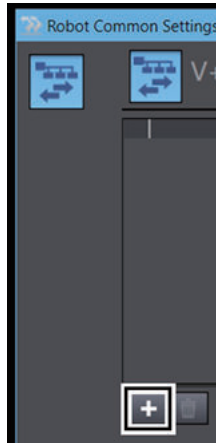

A row for registering a new V+ digital I/O is added.

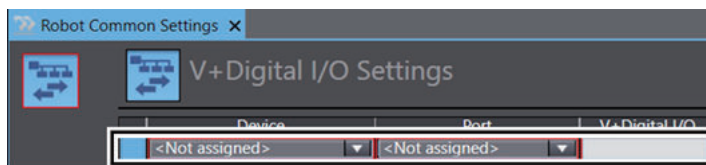

- 5** Click the drop-down list for **Device** in the newly added row, and then select **Node:1 GX-MD3218(E001)**.

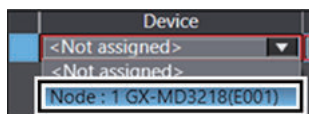

- 6** Click the drop-down list for **Port** in the same row, and select **Out Bit00**.



- 7** Enter **4001** for *V+Digital I/O*.



## Writing V+ Programs

This section describes the procedure to create V+ programs.

- 1** Select **RobotControlSettings** from the device list in the Multiview Explorer.

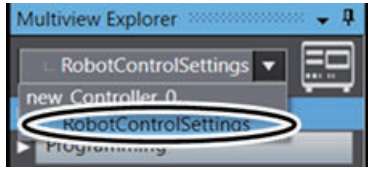

- 2 Right-click **V+ Modules** under **Programming** in the Multiview Explorer, and select **Add New Module** from the menu.

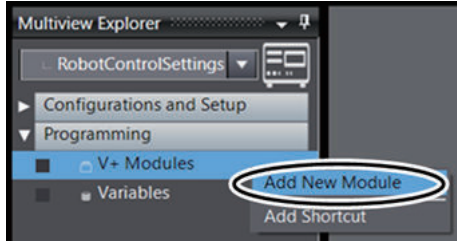

In the tree of the Multiview Explorer, **program0 - program0** are added under **V+ Modules**, which allows you to edit the name of the V+ program.

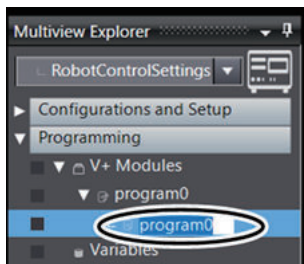

- 3 Enter the name of the V+ program.  
The name of the V+ program is changed.

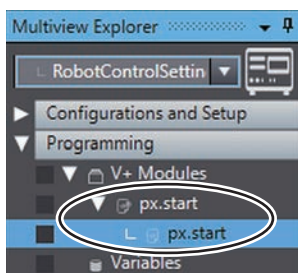

- 4 Double-click the program to edit.

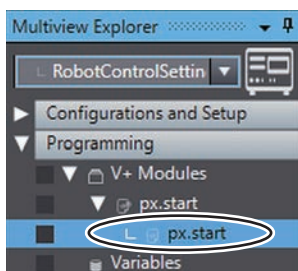

A tab page to edit the V+ program is displayed in the Edit Pane.

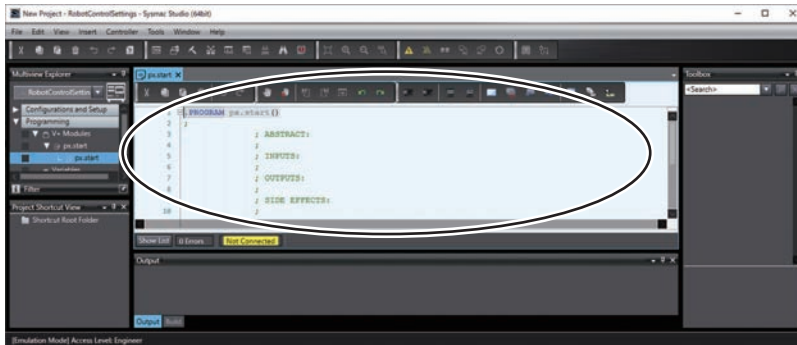

- 5 Create the program in the Edit Pane.  
For details on the program to create, refer to *V+ Program* on page 4-6.
- 6 Go back to step 2 and create another V+ program by repeating the sequence of operations.

#### 4-3-4 Writing a Sequence Control Program

This section provides the procedure for creating a sequence control program.

For details on the program to create and allocation of V+ digital I/Os, refer to *Sequence Control Program* on page 4-4.

### Creating Device Variables

Create device variables to control the inverter.

- 1 In the Multiview Explorer, select **new\_Controller\_0** from the device list.

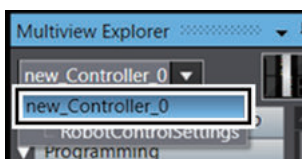

- 2 Double-click **I/O Map** under **Configurations and Setup** in the Multiview Explorer.

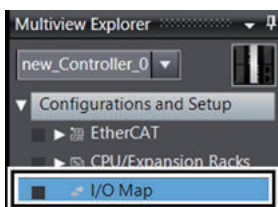

The **I/O Map** tab page is displayed in the Edit Pane.

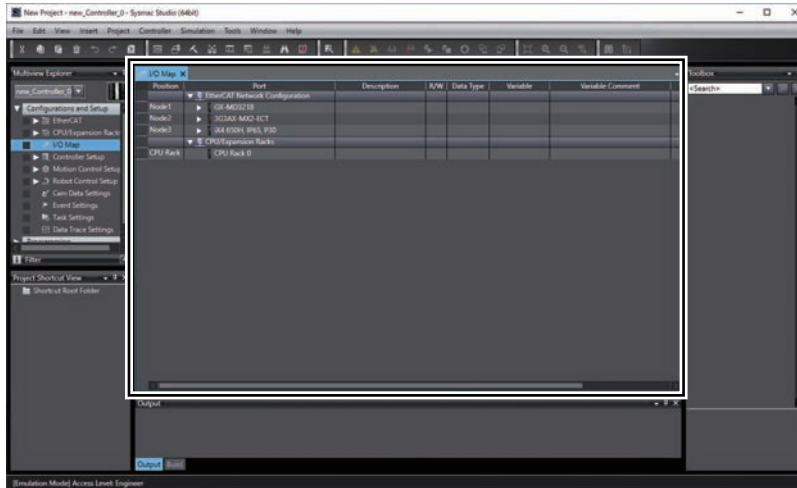

**3** In the **I/O Map** tab page, click the  icon to the left of **3G3AX-MX2-ECT** in the **Port** column.

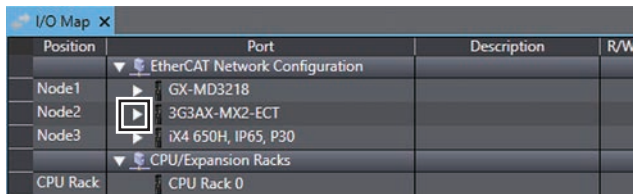

Setting items are displayed under **3G3AX-MX2-ECT** in the tree.

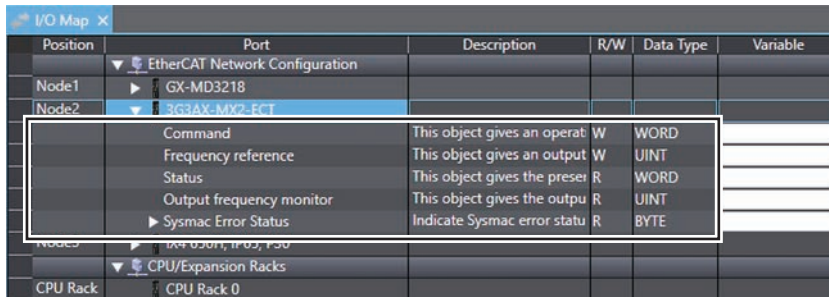

**4** Right-click on the **3G3AX-MX2-ECT** in the **Port** column of the **I/O Map** tab page and select **Create Device Variable** from the menu.

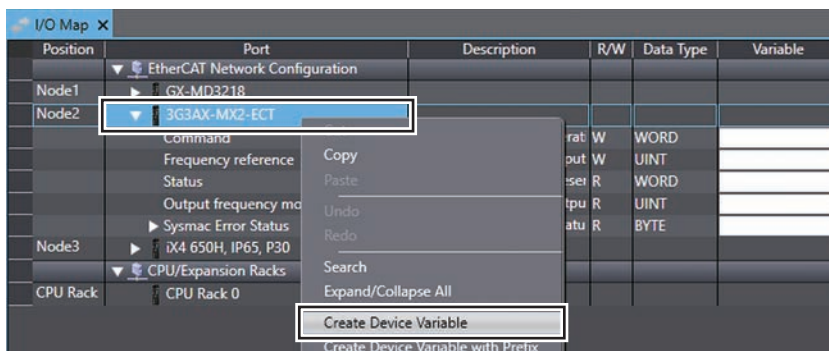

The device variable is created.



Position	Port	Description	R/W	Data Type	Variable
EtherCAT Network Configuration					
Node1	GX-MD3218				
Node2	3G3AX-MX2-ECT				
	Command	This object gives an operat	W	WORD	E002_Command
	Frequency reference	This object gives an output	W	UINT	E002_Frequency_re
	Status	This object gives the presel	R	WORD	E002_Status
	Output frequency monitor	This object gives the outpu	R	UINT	E002_Output_frequ
	Sysmac Error Status	Indicate Sysmac error statu	R	BYTE	E002_Sysmac_Erro
Node3	iX4 650H, IP65, P30				
CPU/Expansion Racks					
CPU Rack	CPU Rack 0				

## Defining Global Variables

Define global variables used as the position data in the sequence control program.

- 1 Double-click **Global Variables** under **Programming - Data** in the Multiview Explorer. Or, right-click **Global Variables** under **Programming - Data** and select **Edit** from the menu.

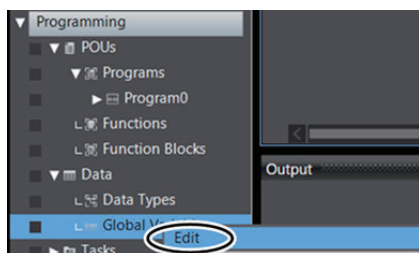

The global variable table is displayed.

Name	Data Type	Initial Value	AT	Retain	Constant	Network Publish
robot001	_SRC_RBT_REF	RC://_RC_RBT[0]			<input checked="" type="checkbox"/>	Do not publish
RC_Robot001_IO	_SRC_RBT_IO_REF	RC://_RC_RBT_IO[0]				Do not publish
E002_Command	WORD	ECAT://node#2/Co		<input type="checkbox"/>	<input type="checkbox"/>	Do not publish
E002_Frequency_refer	UINT	ECAT://node#2/Fre		<input type="checkbox"/>	<input type="checkbox"/>	Do not publish
E002_Status	WORD	ECAT://node#2/Sta		<input type="checkbox"/>	<input type="checkbox"/>	Do not publish
E002_Output_frequen	UINT	ECAT://node#2/Ou		<input type="checkbox"/>	<input type="checkbox"/>	Do not publish

- 2 Press the **Insert** key in the global variable table, or right-click in the global variable table and select **Create New** from the menu.

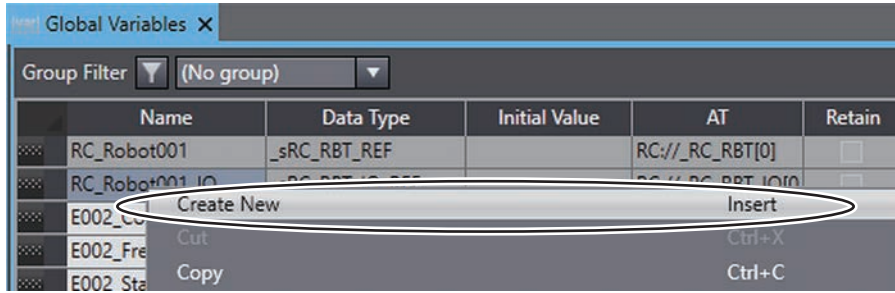

- 3 Enter or select setting for each item and press the **Enter** key.

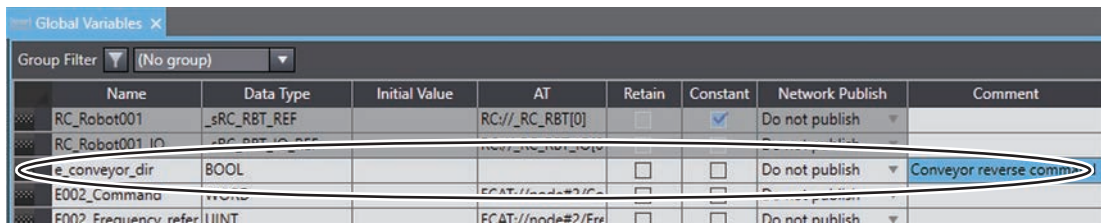

Refer to *Sequence Control Program* on page 4-4 for the global variables to register.

The global variable is registered.

## Creating Ladder Diagram Programs

This section describes how to create the ladder diagram programs.

- 1 Right-click **Program0** under **Programming - POUs - Programs** in the Multiview Explorer and select **Rename** from the menu.

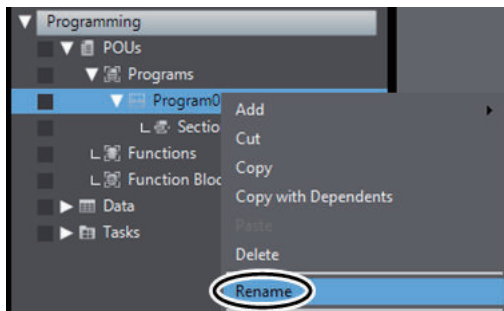

This allows you to edit the name of the sequence control program.

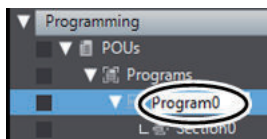

- 2 Enter the name of the sequence control program.  
The name of the sequence control program is changed.

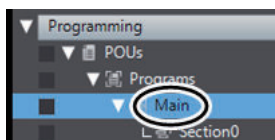

- 3 Double-click the section to edit.

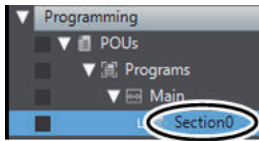

The variable table and Ladder Editor are displayed in the Edit Pane.

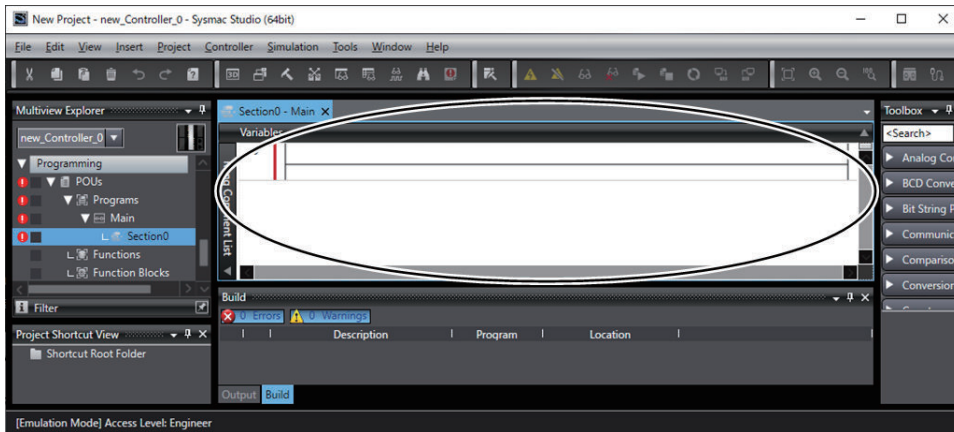

- 4 Enter the program in the Ladder Editor. Internal and external variables are automatically registered when they are entered in the program.  
For details on the program to create, refer to *Sequence Control Program* on page 4-4.  
To create more than one sequence control program, perform the following steps.

- 5 Right-click **Programs** under **Programming - POUs** in the Multiview Explorer, and then select **Add - Ladder** from the menu.

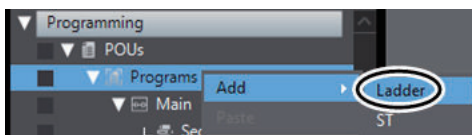

**Program0** is added under **Programs**.

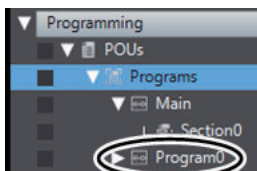

- 6 Click the icon displayed to the left of **Program0** under **Programming - POUs - Programs** in the Multiview Explorer.

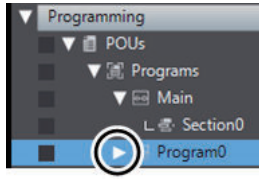

**Section0** is added under **Program0**.

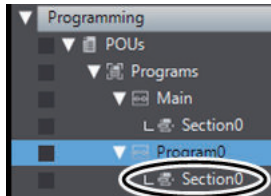

**7** Returns to step 1 and repeat the above steps.

## Assigning Programs to Tasks

In this section, assign the ladder diagram programs to tasks of the Robot Integrated CPU Unit.

In this guide, multiple ladder diagram programs are used to control the dynamic pick-and-place equipment, so it is necessary to assign the programs to tasks.

When the equipment is controlled by the V+ Program, only one ladder diagram program is used and you do not need to perform the steps in this section.

**1** Double-click **Task Settings** under **Configurations and Setup** in the Multiview Explorer.

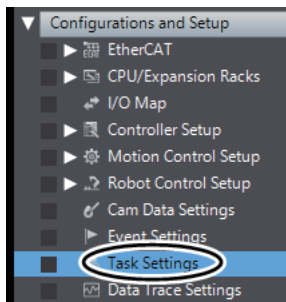

The **Task Settings** tab page is displayed.

**2** Click the **Program Assignment Settings** button (  ) in the Edit Pane.

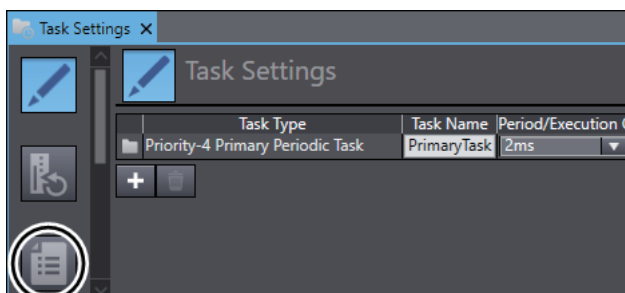

- 3 Click the + button.

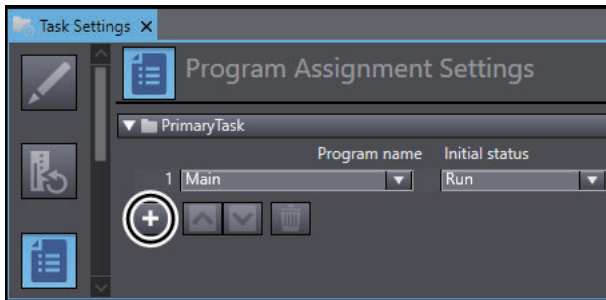

A new row is added for the program to assign.

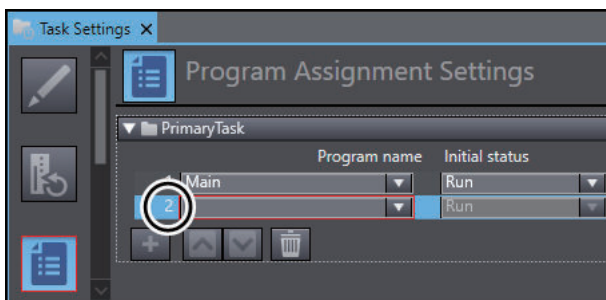

- 4 Select a name of the program to use from the list of the **Program name**.

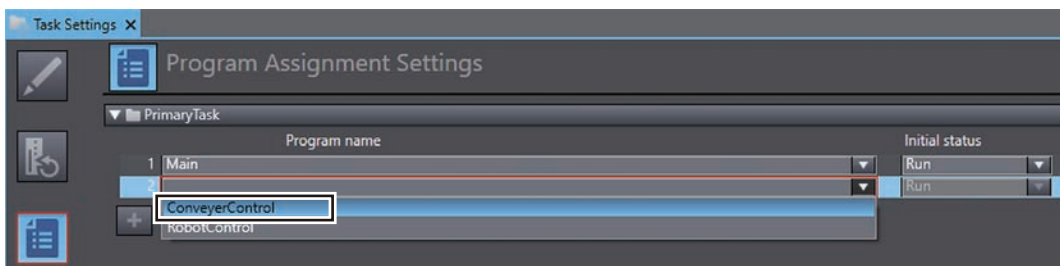

The name of the selected program is displayed.

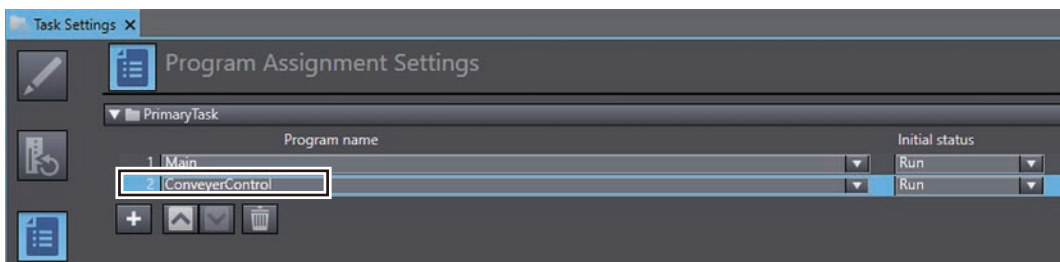

- 5 Perform step 3 and later for **RobotControl**.

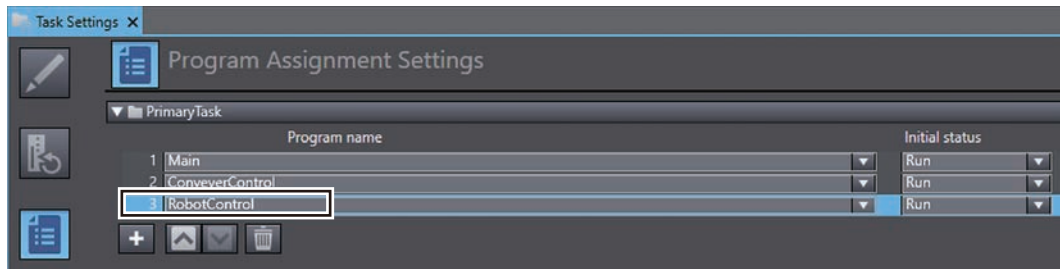

### 4-3-5 Placing 3D Shape Data

#### Making the Robot Motion Range Visible

You can make the operating range of the robot visible on the 3D Visualizer. Making the operating range visible makes it easier to set the position of the robot.

- 1 Select **3D Visualizer** from the **View** menu on the main window of the Sysmac Studio.

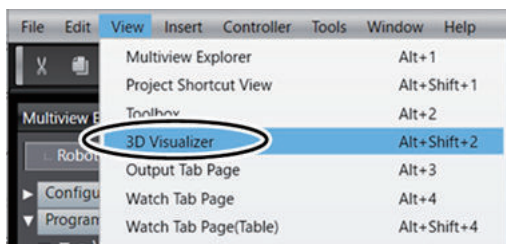

- 2 In the 3D Visualizer, click the Scene Graph icon.

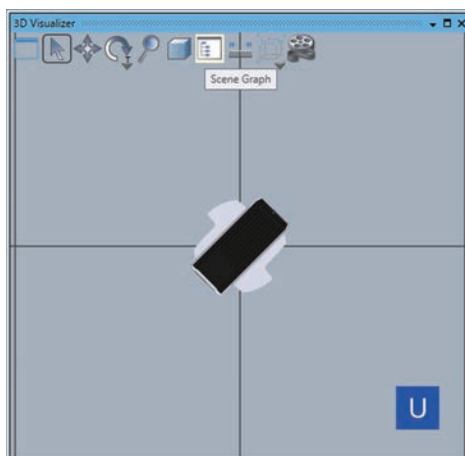

**Note** The 3D Visualizer is in Float mode in this procedure. For information on Float mode, refer to *A-2-1 Set the 3D Visualizer to the Float Mode* on page A-21.  
The **Scene Graph** dialog box is displayed.

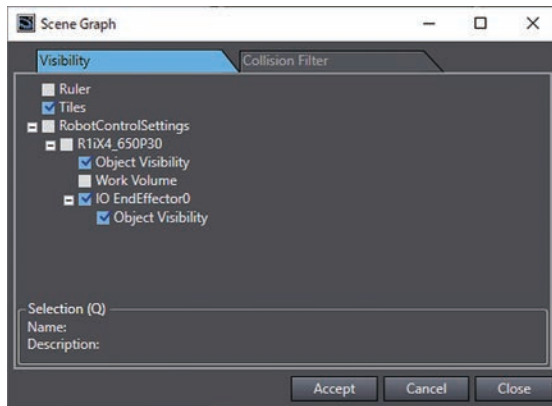

- 3** In the **Visibility** tab page, select the **Work Volume** check box located under **RobotControlSettings - R1iX4\_650P30**.

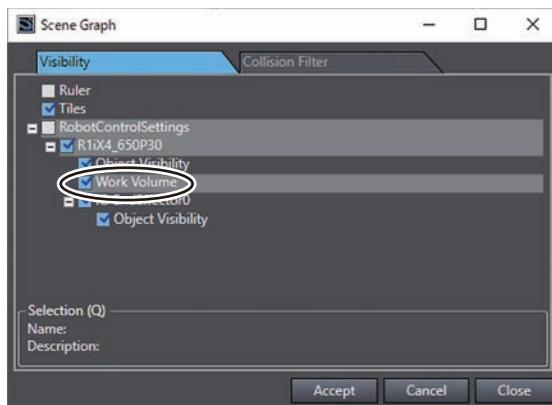

The 3D Visualizer illustrates the robot's operating range in gray.

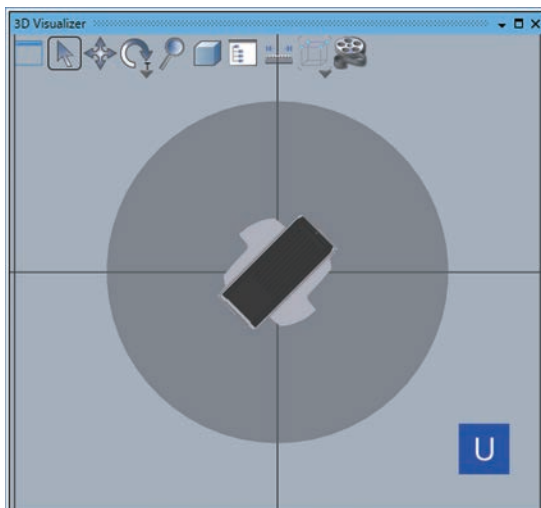

- 4** Click the **Close** button on the **Scene Graph** dialog box.

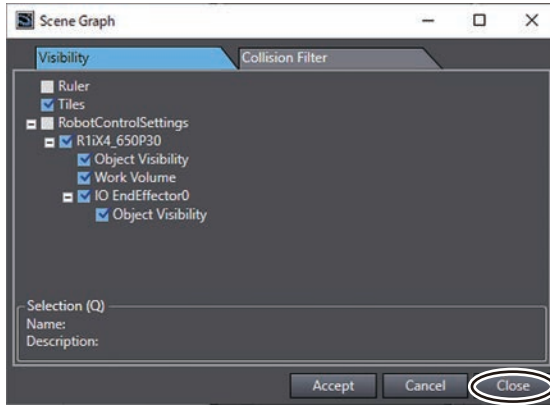

## Placing the Robot on the 3D Visualizer

Place the robot in the appropriate position on the 3D Visualizer.

- 1 Select **3D Visualizer** from the **View** menu on the main window of the Sysmac Studio.

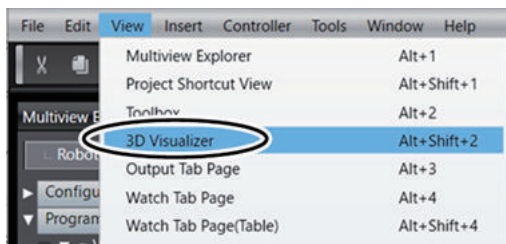

The 3D Visualizer is displayed on the right side of the main window.

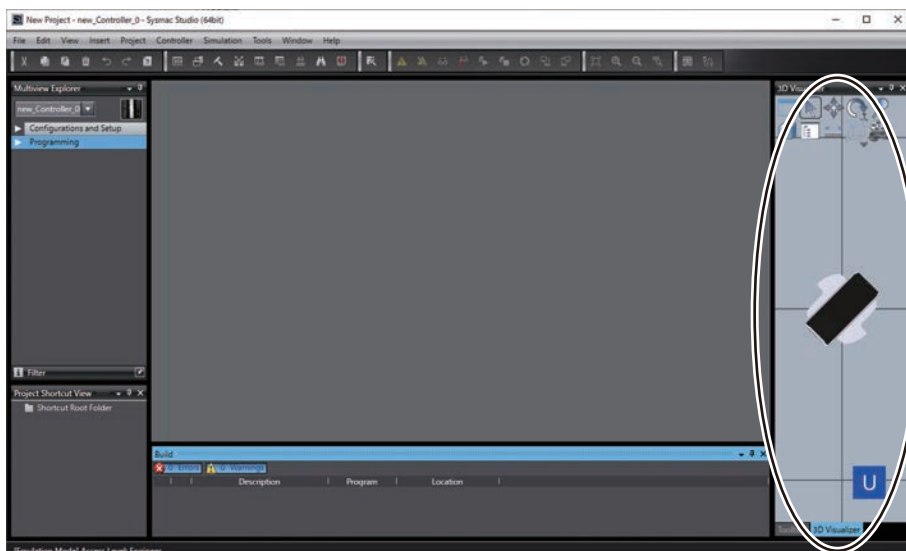

- 2 Make the 3D Visualizer get into Float mode, and move the viewpoint as shown below.



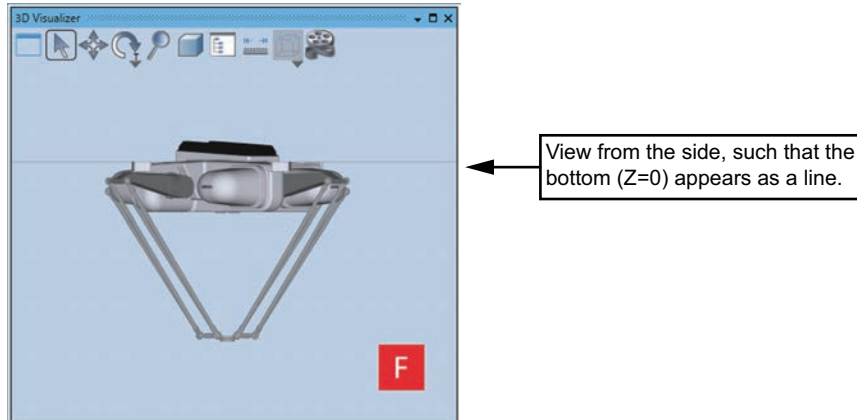

### Additional Information

For information on how to change the viewpoint in the 3D Visualizer, refer to the *A-2 How to Use 3D Visualizer* on page A-21.

- 3 Move the mouse cursor onto the robot and right-click it.  
The menu commands are displayed.



### Additional Information

When the mouse cursor is moved onto the robot, the name of the 3D shape data / **RobotControlSettings/R1IX4\_650P30** is displayed.

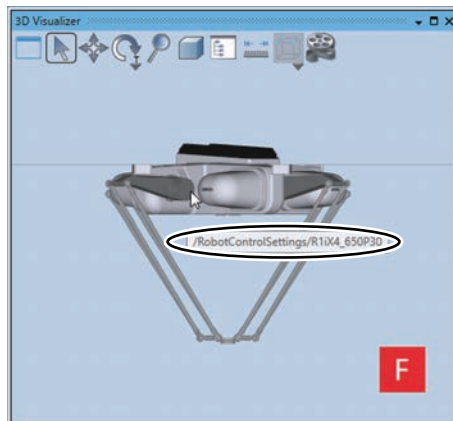

- 4 Select **Edit Workspace Position** from the menu.

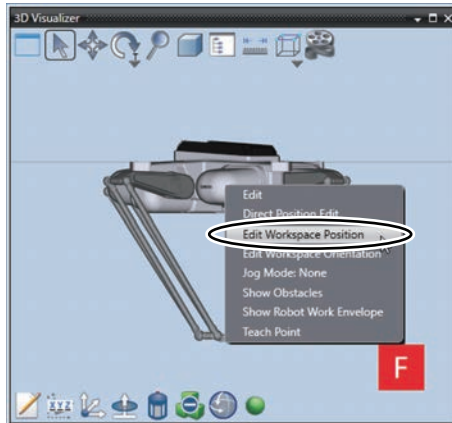

The Move icon consisting of colored arrows, a purple circle, and faces is displayed on the origin of the 3D shape data.

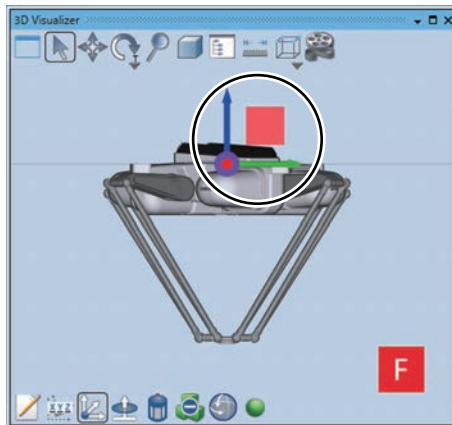

### Additional Information

The Move icon has red, green, and blue arrows, which represent the X-axis, Y-axis, and Z-axis, respectively. The red face shows the YZ plane, the green face shows the ZX plane, and the blue face shows the XY plane.

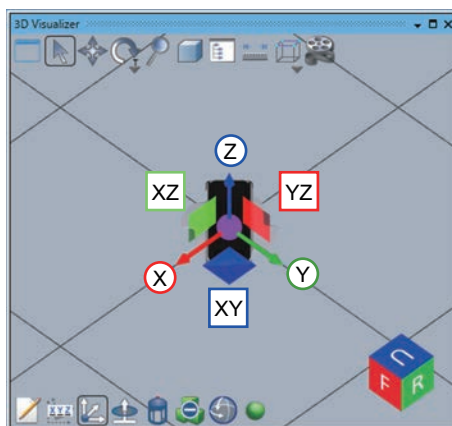

You can drag an arrow to move the 3D shape data along the axis.

Or, use the face icon to move the 3D shape data on the corresponding plane. You can also move the 3D shape data independently from the axis direction by dragging the purple circle.

- 5** Move the mouse cursor onto the robot and right-click it, and select **Show Robot Work Envelope** from the menu.

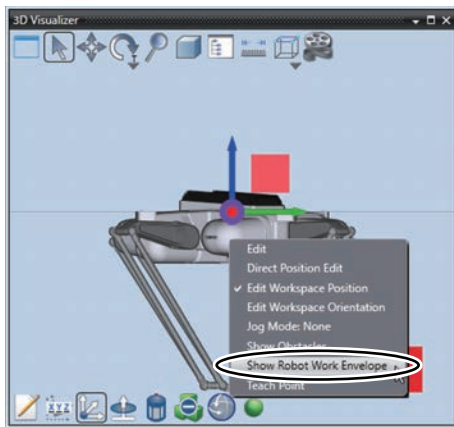

The robot's operating range is colored in gray in the 3D Visualizer.

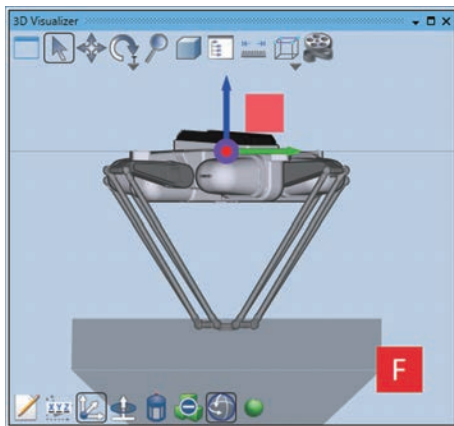

- 6** Click the blue arrow and drag upward to pull the robot upward in Z-axis direction from the origin.

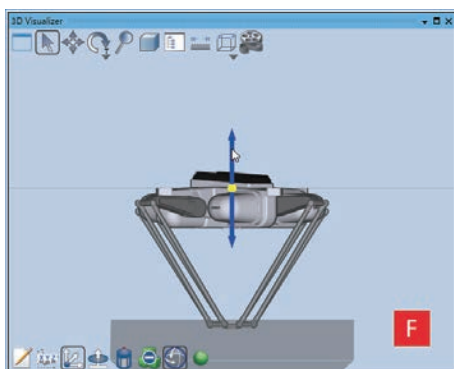

Move it so that the operating range is above the bottom surface.

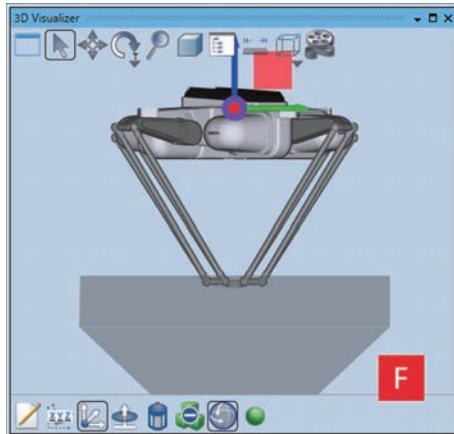

### Additional Information

You can zoom in on the 3D Visualizer to see the operating range more clearly. You can also check the position on the X, Y, and Z axes in numbers by clicking the **Direct Position Edit** icon.

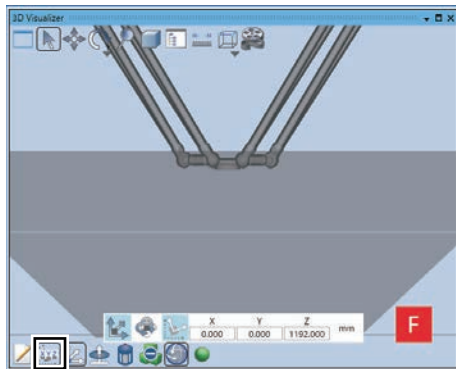

For information on how to zoom in or zoom out in the 3D Visualizer, refer to the *A-2-4 Zoom-in and Zoom-out* on page A-26.

## Importing 3D CAD Data and Placing It on the 3D Visualizer

Import the 3D CAD data of the conveyors as 3D shape data to the Sysmac Studio.

This section describes the procedure to import the 3D CAD Data of Conveyor A and Conveyor B to be used as equipment models and place them on the 3D Visualizer.

- 1 Select **Application Manager** from the **Insert** menu on the main window of the Sysmac Studio.

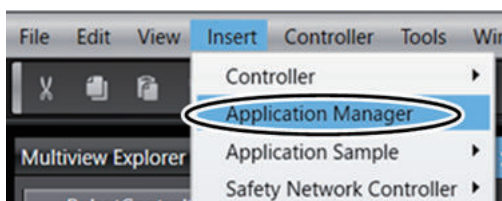

The **Add Device** dialog box is displayed.

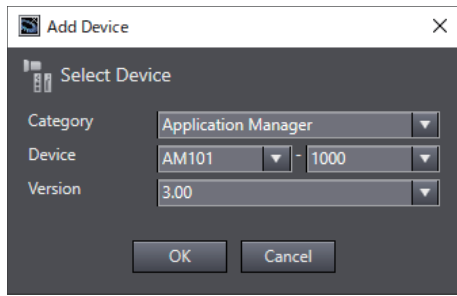

- 2** Select an item from the drop-down list of **Category**, **Device**, and **Version** as shown in the figure below, and then click the **OK** button.

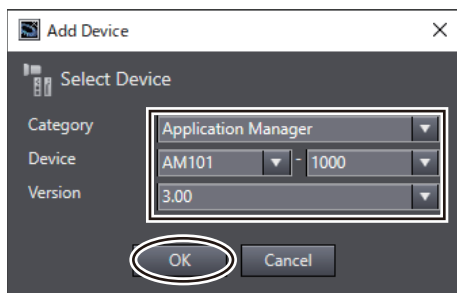

**ApplicationManager0** is added to the drop-down list at the top of the Multiview Explorer

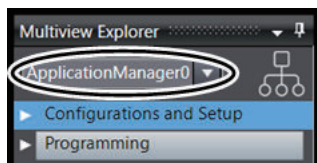

### Additional Information

Application Manager added by this operation can only be used for simulation. Do not use it for actual device.

- 3** Click **Configurations and Setup** in the Multiview Explorer.

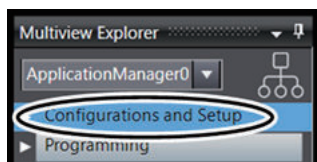

Setting items are displayed under **Configurations and Setup** in the tree.

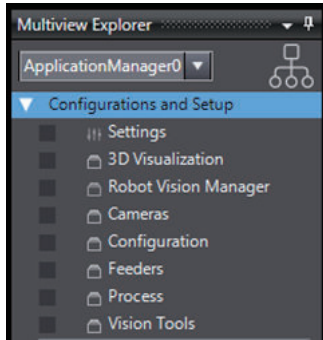

**4** Right-click **3D Visualization**.  
The menu commands are displayed.

**5** From the menus, select **Add - CAD Data**.

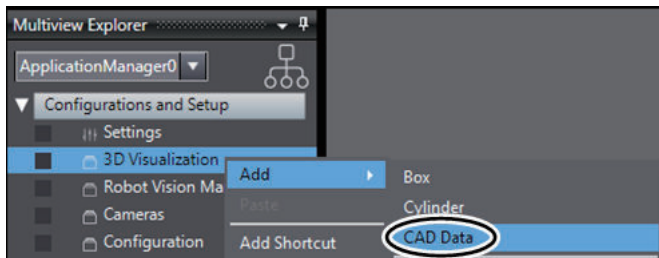

The **Import CAD File** wizard starts.

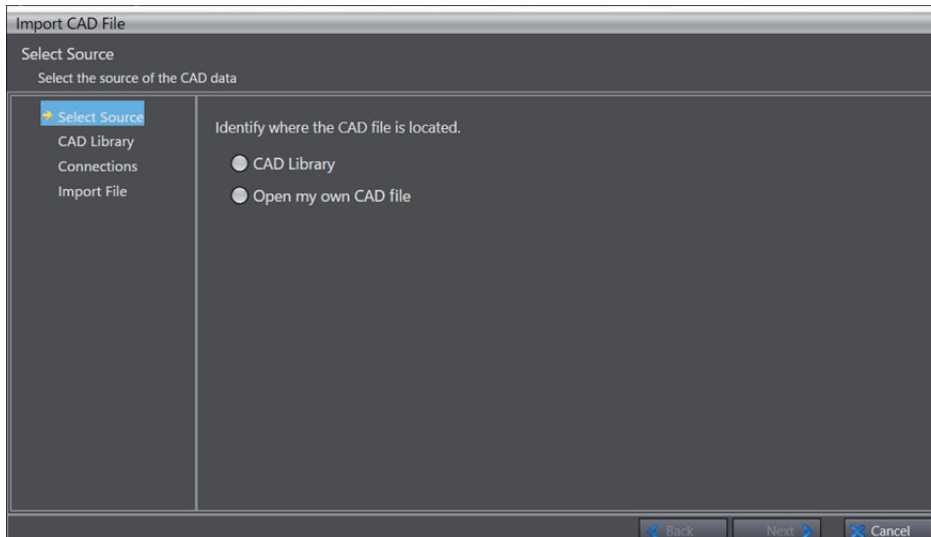

**6** Select **Open my own CAD file** check box.

**7** Click the **Next** button.

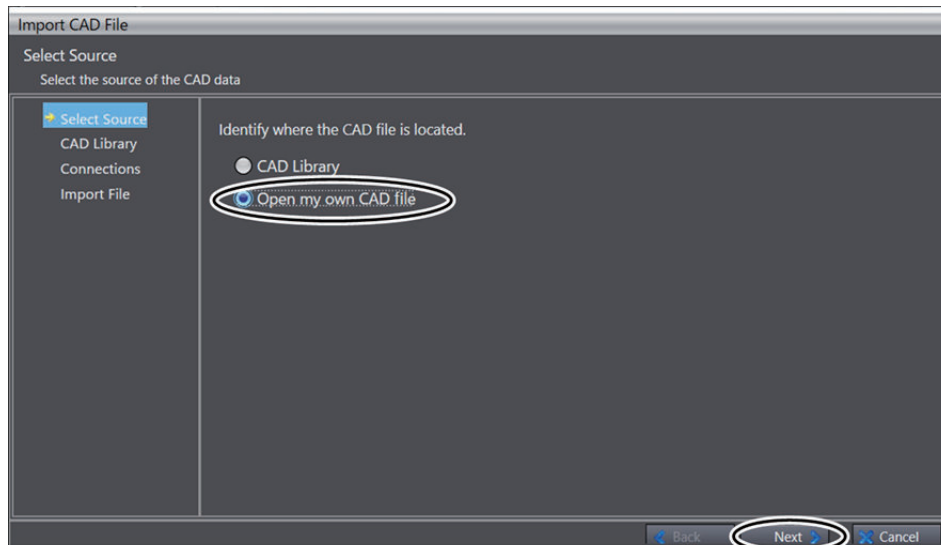

- 8 Click the **Open File** button.

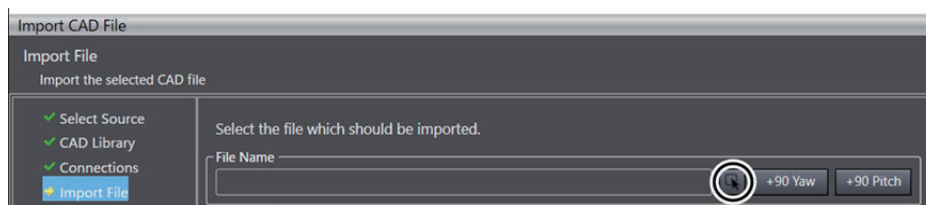

The **Open** dialog box is displayed.

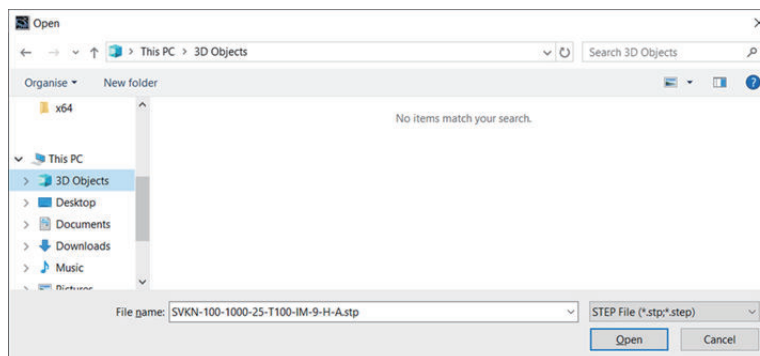

- 9 Select a 3D CAD data to import, and then click the **Open** button.  
In this example, you select the conveyor of MISUMI Corporation whose model number is SVKN-100-1000-25-T100-IM-9-H-A for the Conveyor A. You can import the 3D CAD data with the file name extension “stp”.

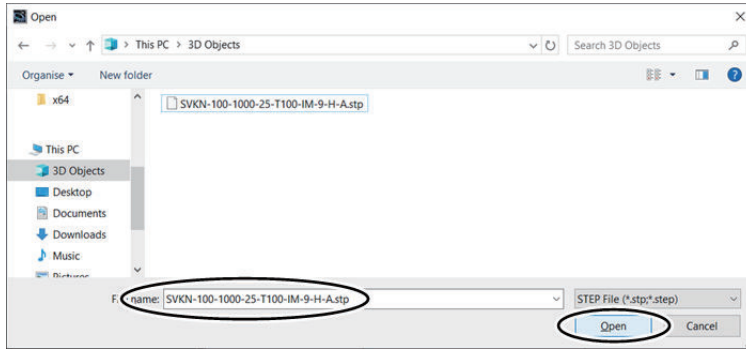

The **Open** dialog box is closed and import of 3D CAD data starts automatically.

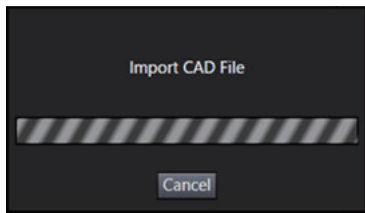

When the import completes, the assemblies of the imported 3D CAD data is displayed in the **Import CAD File** wizard.

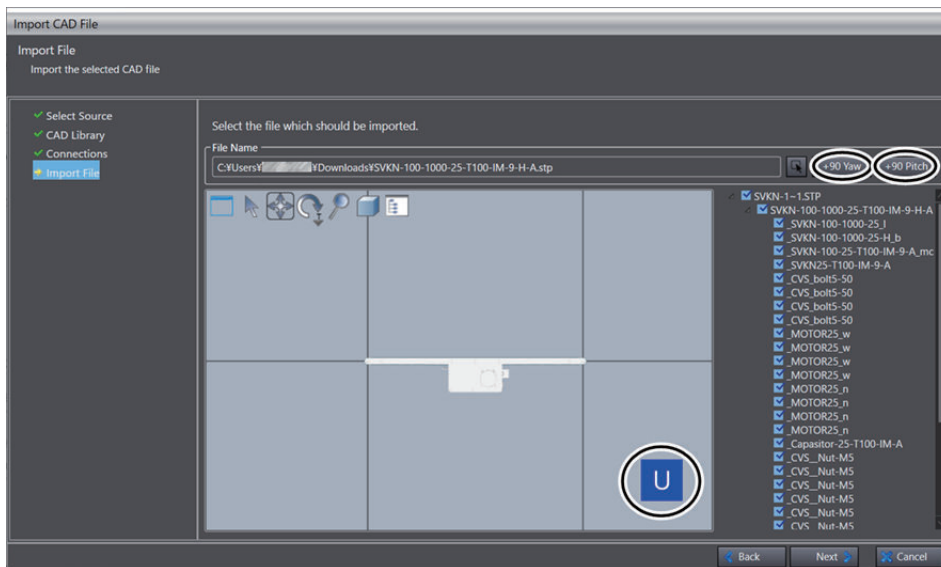

### Additional Information

Align the conveyor top to the U face. Click the **+90 Yaw** button or **+90 Pitch** button to change the orientation of the conveyor.

If you use positioned and oriented CAD data, this operation is not necessary.

**10** Click the buttons in the following order; **+90 Yaw**, **+90 Pitch**, **+90 Yaw**, **+90 Pitch** and **+90 Pitch**

The conveyor top comes to the U face.



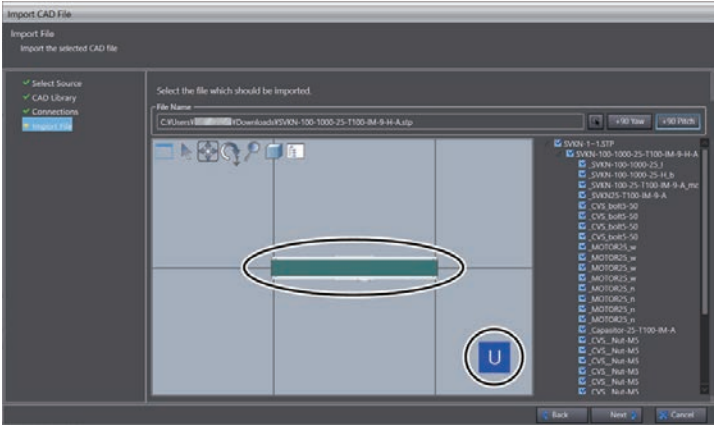

**11** Select the parts to add for simulation, and click the **Next** button.

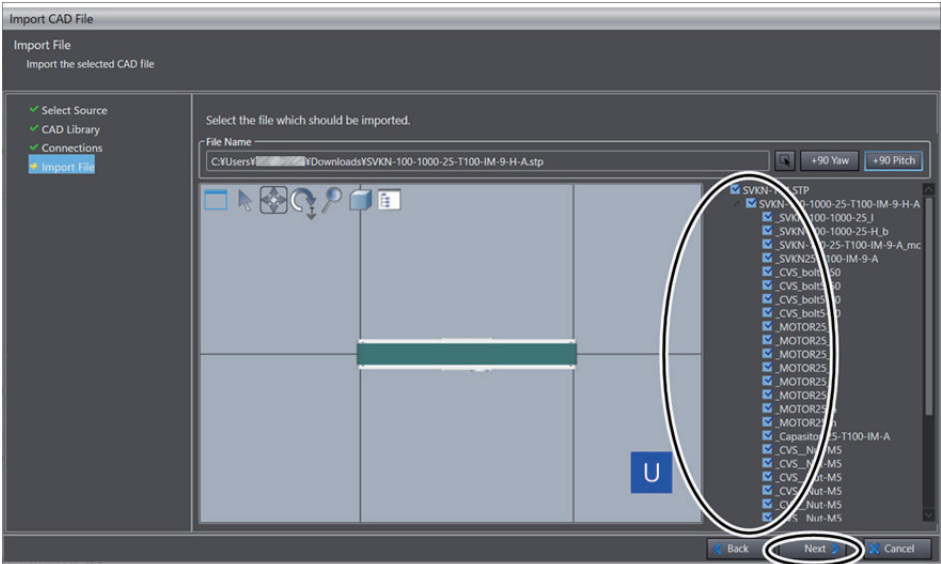

The **Import CAD File** wizard is closed and the main window is displayed again.

**12** Check that **CAD Data0** is added under **Configurations and Setup - 3D Visualization** in the Multiview Explorer.

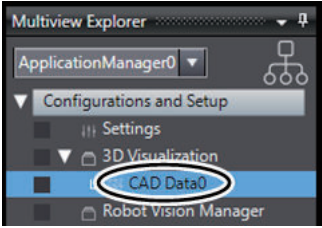

**13** Place the conveyor A in the same manner as in *Placing the Robot on the 3D Visualizer* on page 4-32.

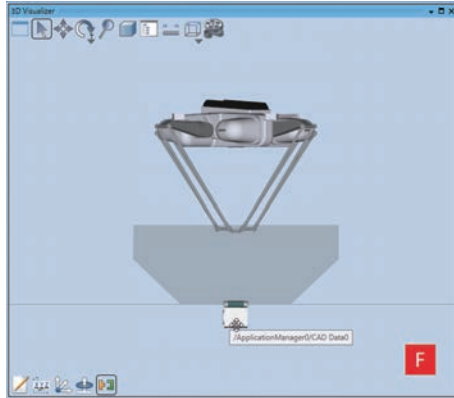

Place the conveyor A in a position where the robot can pick up the workpiece within the operating range of the robot.

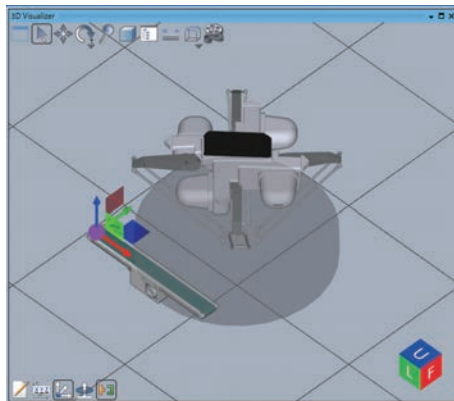

### 14 Perform step 4 and later for the Conveyor B.

In the Multiview Explorer, **CAD Data1** is added under **Configurations and Setup - 3D Visualization**.

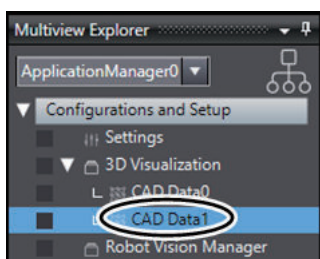

Place the conveyor B within the operating range of the robot, where the robot can place the workpiece.

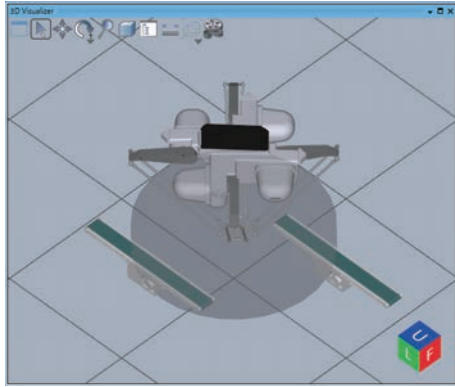

Now import of the 3D CAD data for Conveyor A and Conveyor B and their placement are completed.

## Activating Collision Detection Function

The collision detection function detects the contacts in simulation that may occur between the robot and other 3D shape data, such as objects imported as 3D CAD data. If the robot may contact with other 3D shape data, you need to change the layout of the robot or the 3D shape data or modify the movement of the robot.

In this section, the setting procedure to detect a contact between the robot, Conveyor A and Conveyor B is given. Because the collision detection function checks whether 3D shape data may collide between groups, you create two groups; Group 0, which includes the robot, and Group 1, which includes Conveyor A and Conveyor B.



### Precautions for Correct Use

In this guide, the target of collision detection is the robot. When the 3D shape data is placed at the tool center point, collision detection of that 3D shape data is also required. For information on collision detection operation in which the 3D shape data attached to the tool center point is subject to the collision detection, refer to the *Sysmac Studio 3D Simulation Function Operation Manual (Cat. No. W618)*.

- 1 Select **3D Visualizer** from the **View** menu on the main window of the Sysmac Studio.

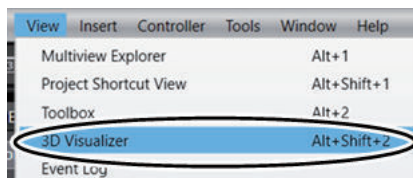

The 3D Visualizer is displayed on the right side of the main window.

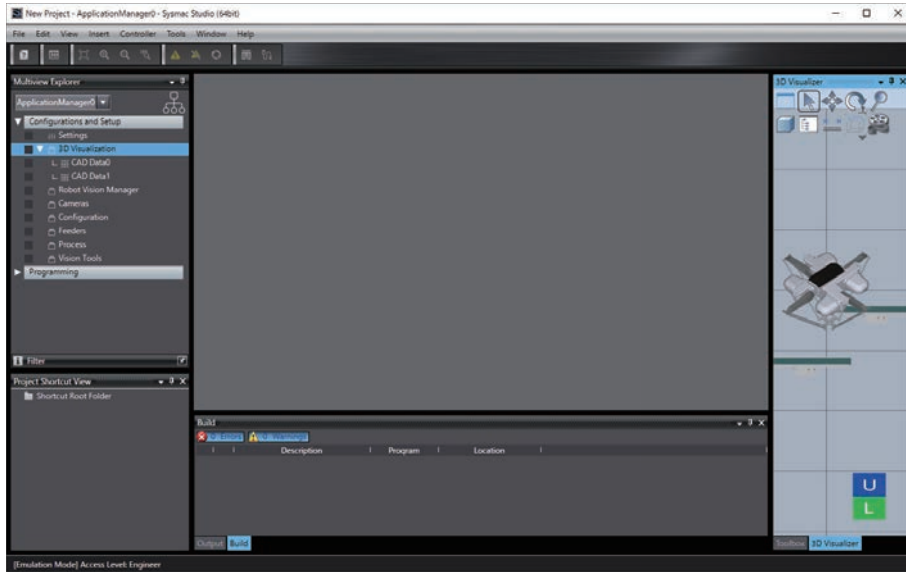

2 In the 3D Visualizer, click the **Scene Graph** icon.

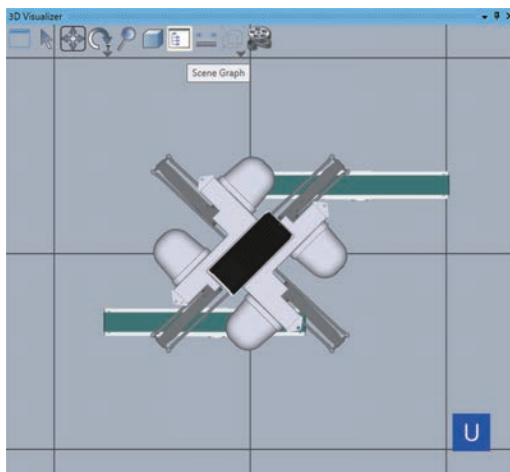

The **Scene Graph** dialog box is displayed.

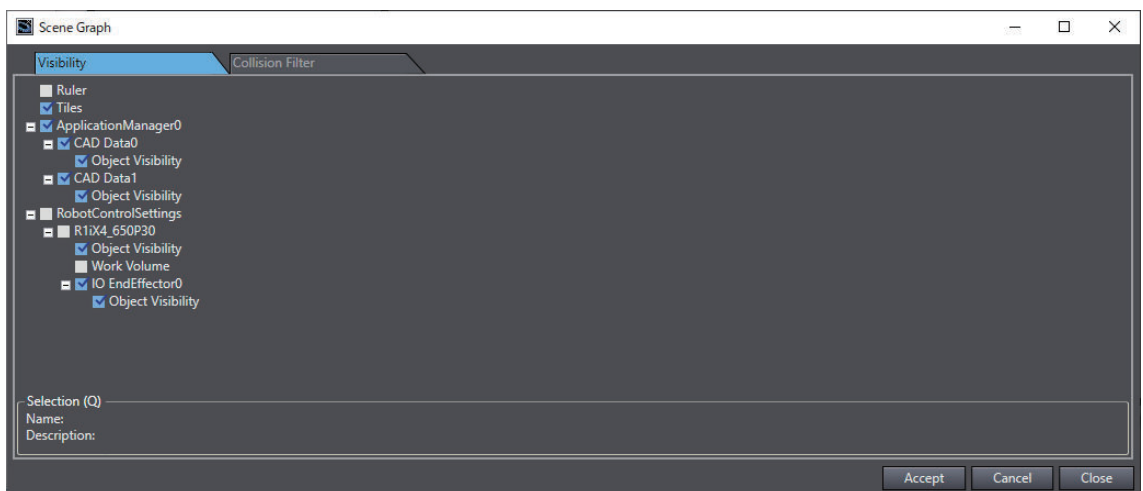

3 Click the **Collision Filter** tab.

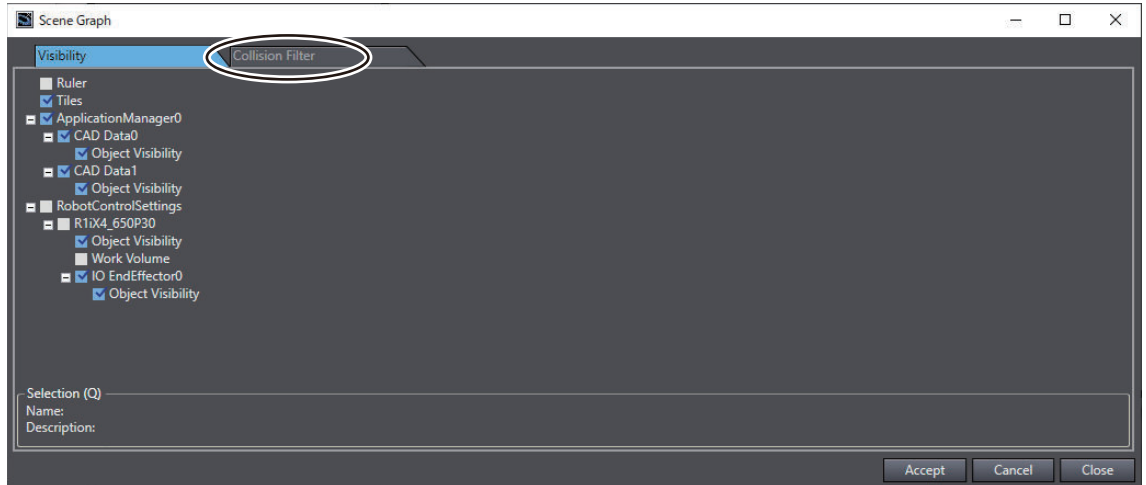

**4** Click the + button in the **Collision Filter Group Items** column for the **Collision Filter Group**.

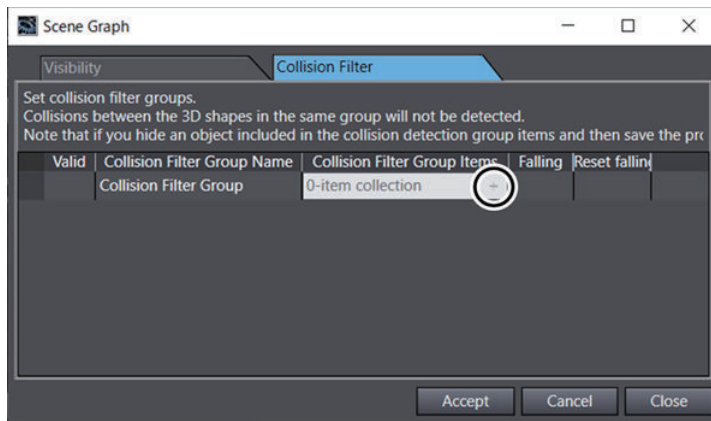

**4**

A new row with the **Collision Filter Group Name** set as **Group0** is added on the **Scene Graph** dialog box.

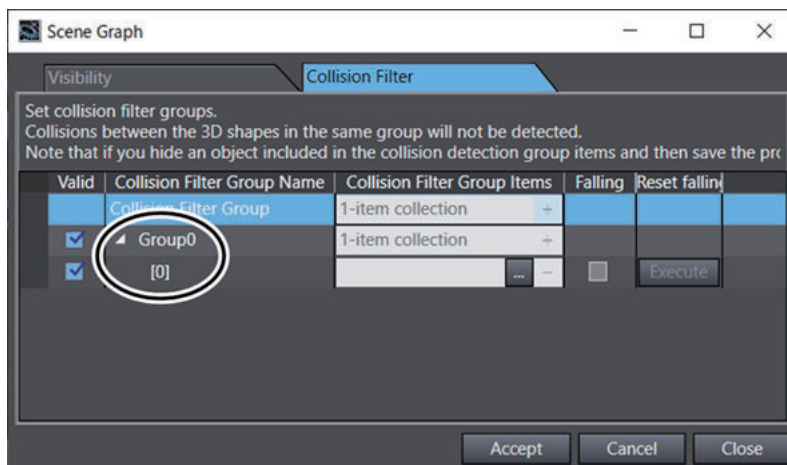

**5** Repeat step 4 above.

A new row with the **Collision Filter Group Name** set as **Group1** is added on the **Scene Graph** dialog box.

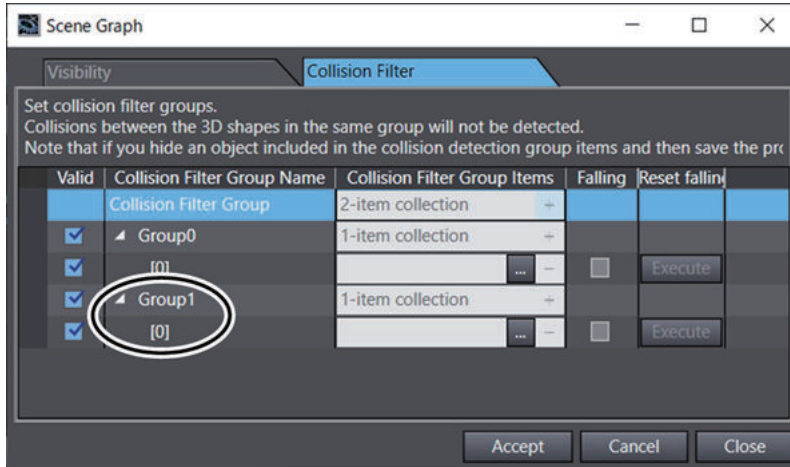

6 Click the ... button in the **Collision Filter Group Items** column for **Group 0 - [0]**.

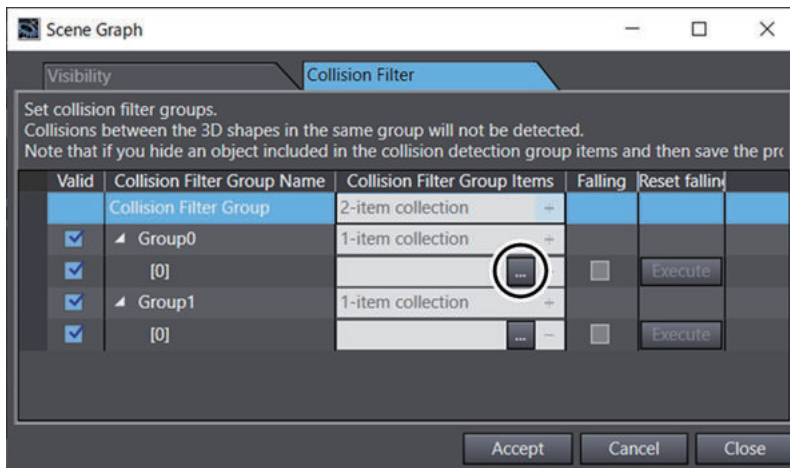

The **Select a collision filter group item** dialog box is displayed.

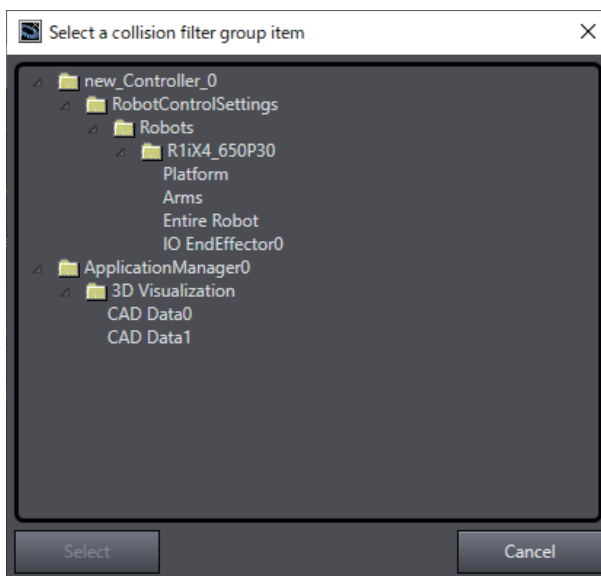

7 Select **new\_Controller\_0 - RobotControlSettings - Robots - R1iX4\_650P30 - Entire Robot** in the tree, and then click the **Select** button.

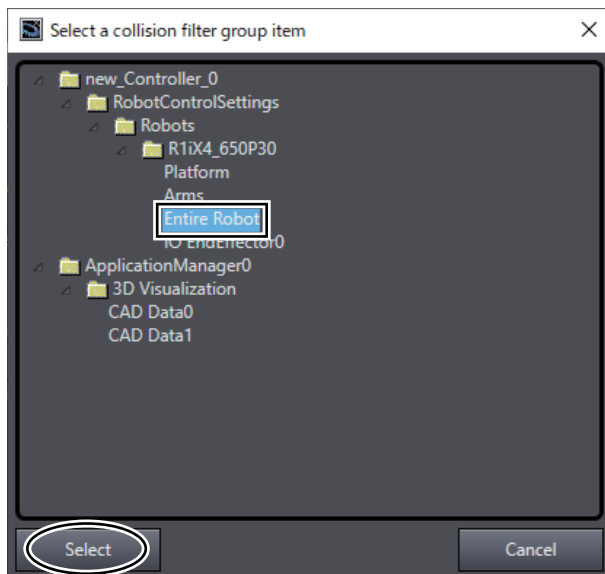

The **Select a collision filter group item** dialog box closes and the **Scene Graph** dialog box is displayed again. **R1iX4\_650P30, Entire Robot** is registered in the **Collision Filter Group Items** column for **Group0 - [0]**.

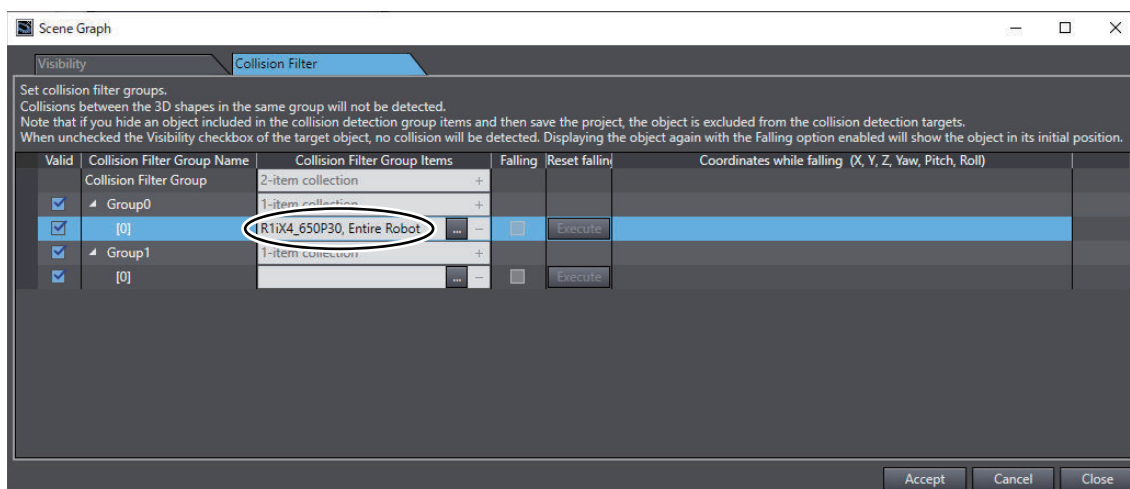

**8** Click the **+** button in the **Collision Filter Group Items** column for **Group 0**.

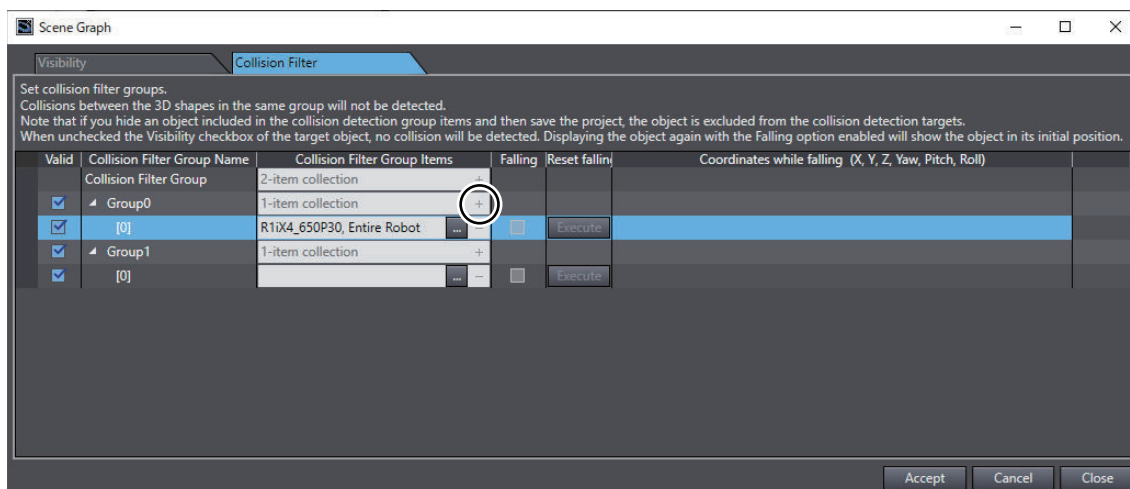

A new row [1] is added under **Group 0**.

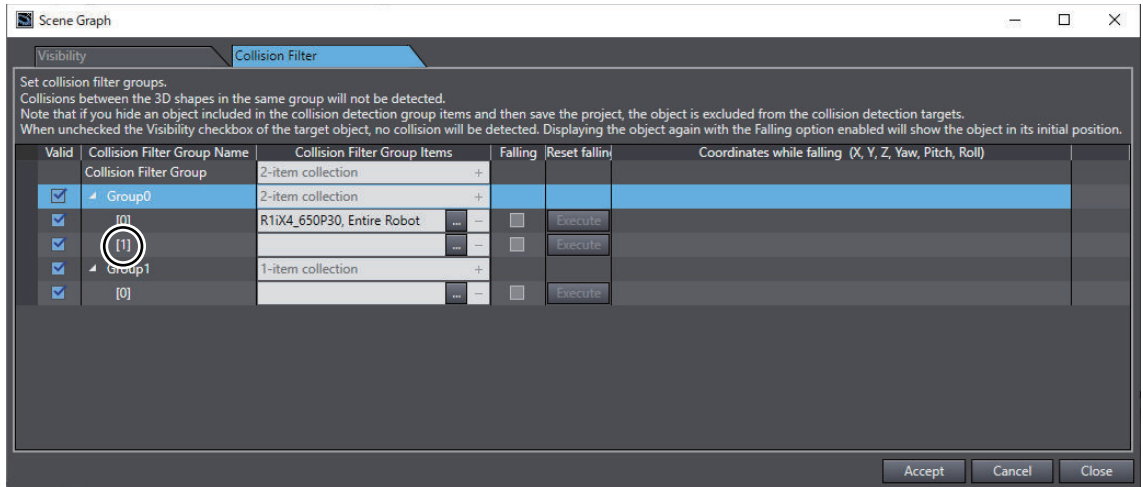

9 Click the ... button in the **Collision Filter Group Items** column for **Group 0 - [1]**.

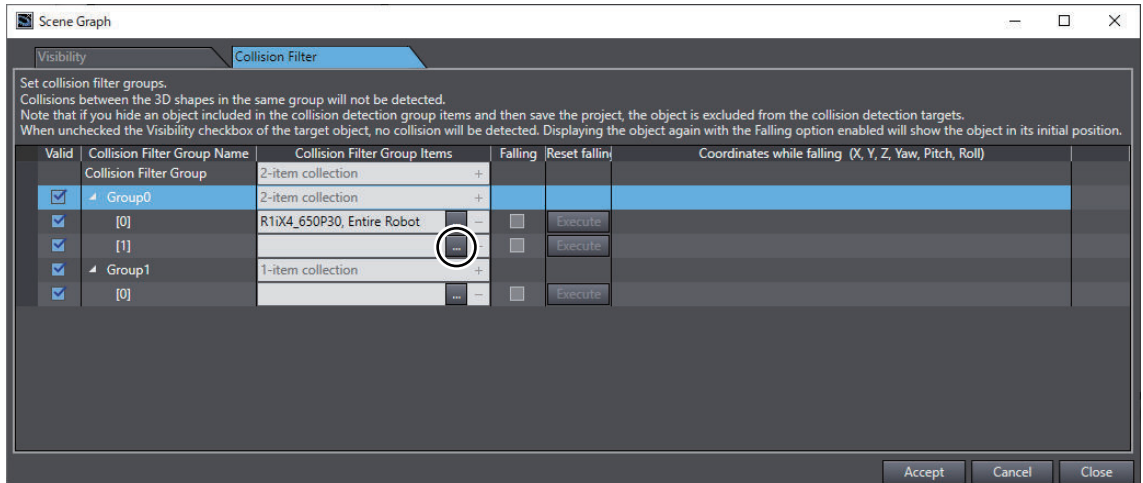

The **Select a collision filter group item** dialog box is displayed.

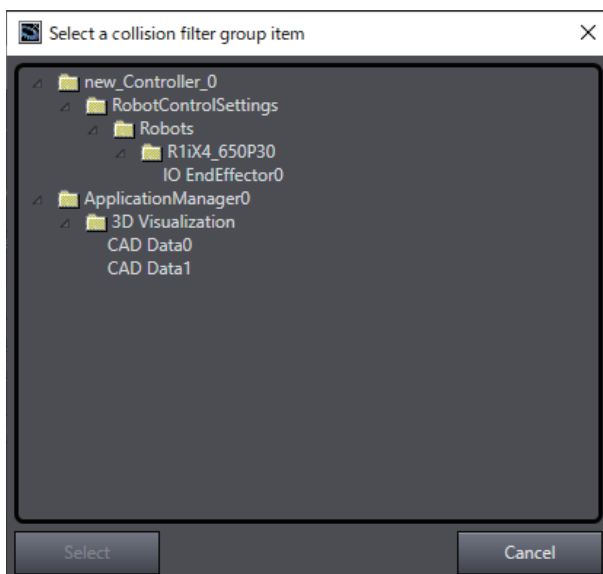



- 10** Select **new\_Controller\_0 - RobotControlSettings - Robots - R1iX4\_650P30 - IO EndEffector0** in the tree, and then click the **Select** button.

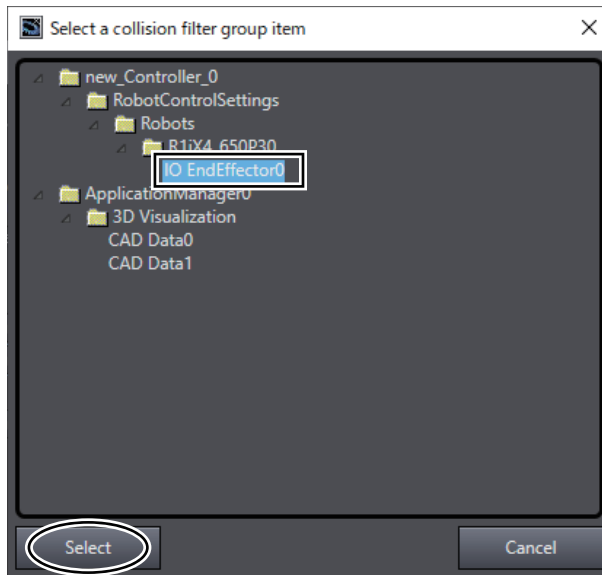

The **Select a collision filter group item** dialog box closes and the **Scene Graph** dialog box is displayed again. **IO End effector 0 (R1iX4\_650P30)** is registered in the **Collision Filter Group Items** column for **Group0 - [1]**.

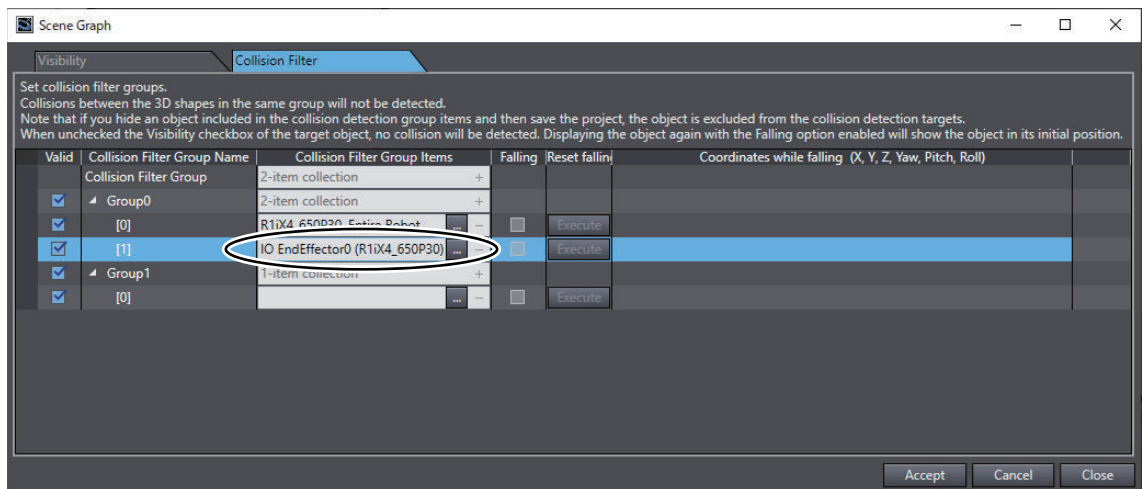

- 11** Click the ... button in the **Collision Filter Group Items** column of the row whose **Collision Filter Group Name** is **Group 1 - [0]**.

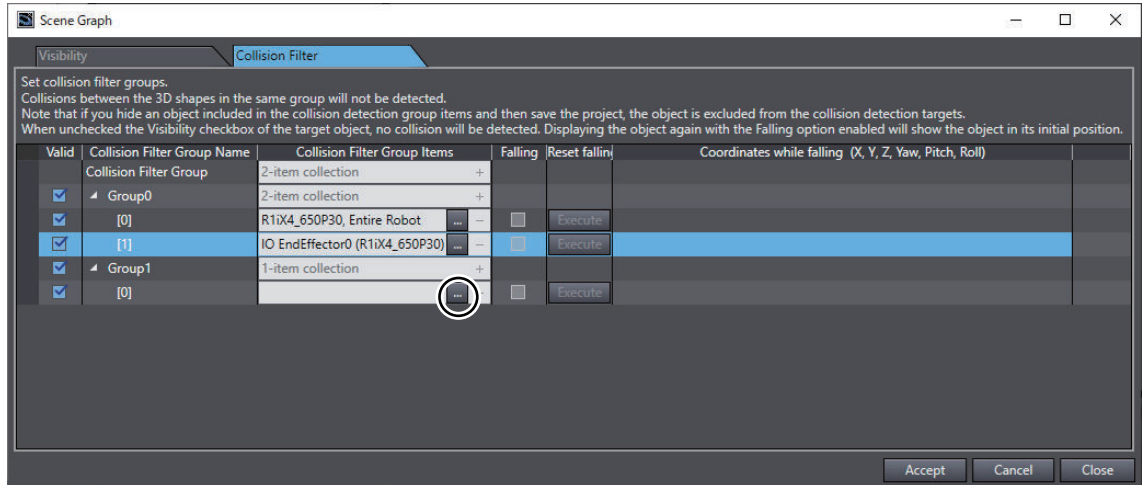

The **Select a collision filter group item** dialog box is displayed.

- 12** Select **ApplicationManager0 - 3D Visualization - CAD Data0** from the tree, and then click the **Select** button.

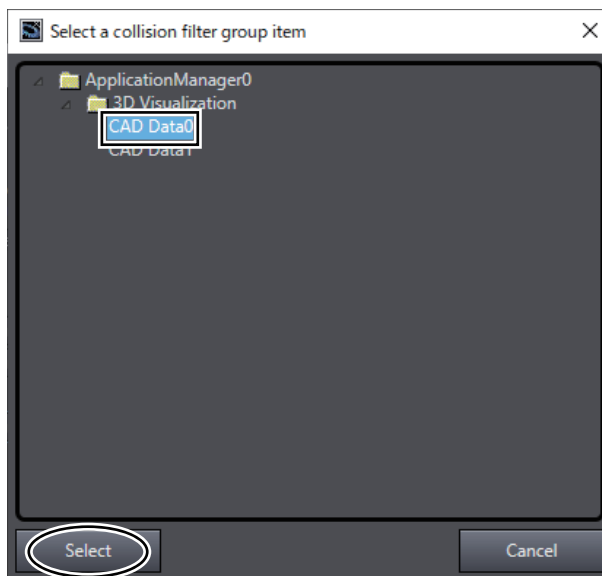

The **Select a collision filter group item** dialog box closes and the **Scene Graph** dialog box is displayed again. **CAD Data0** is registered to the **Collision Filter Group Items** column for **Group 1 - [0]**.

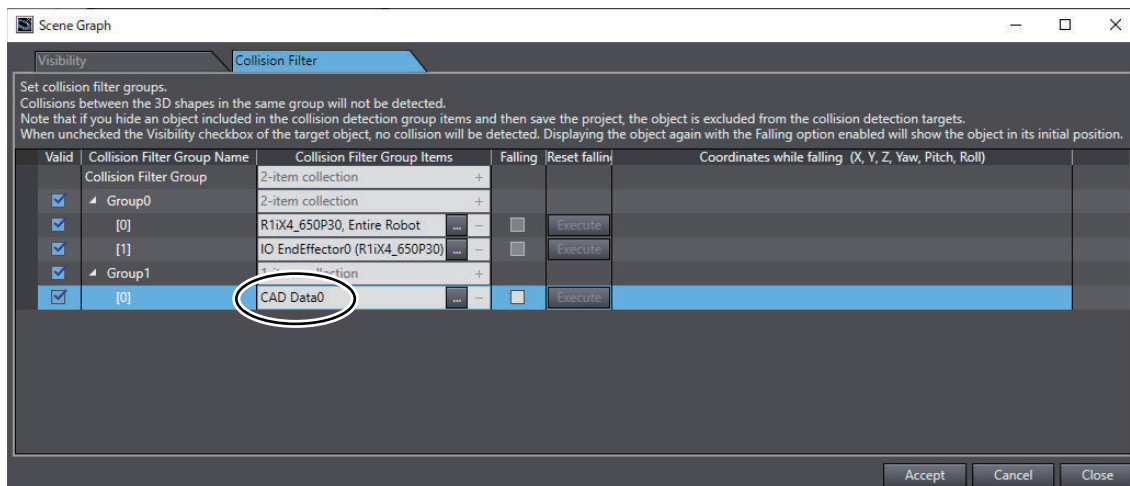

**13** Click the + button in the **Collision Filter Group Items** column for **Group 1**.

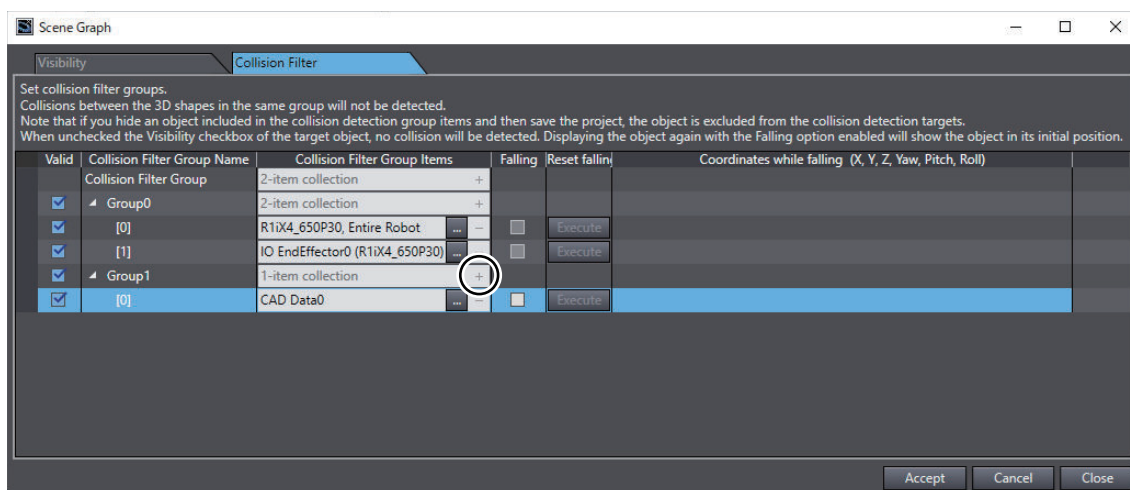

A new row [1] is added under **Group 1**.

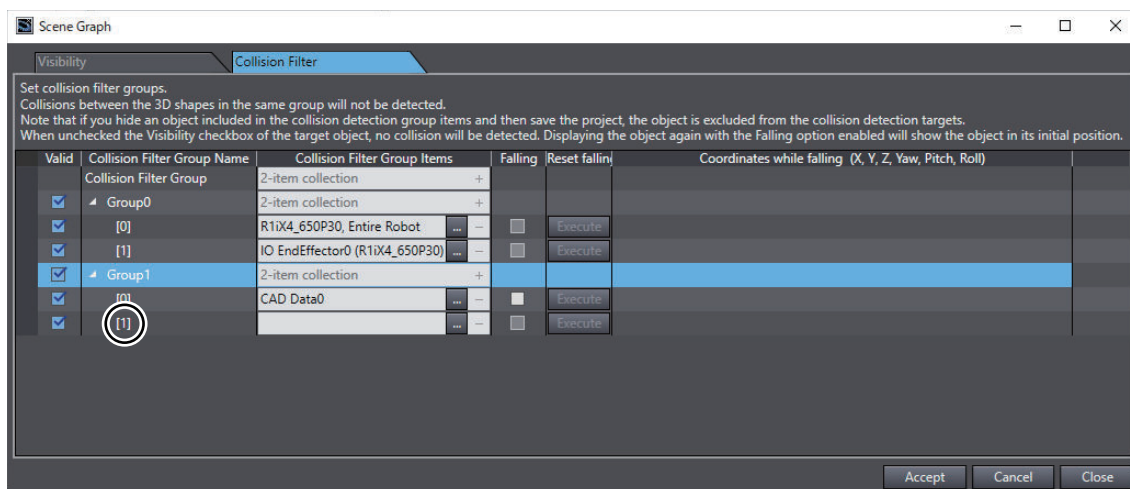

**14** Follow the step 8 to 10 to register **CAD Data1** for **Group 1 - [1]**.

**CAD Data1** is registered to the **Collision Filter Group Items** column for **Group 1 - [1]**.

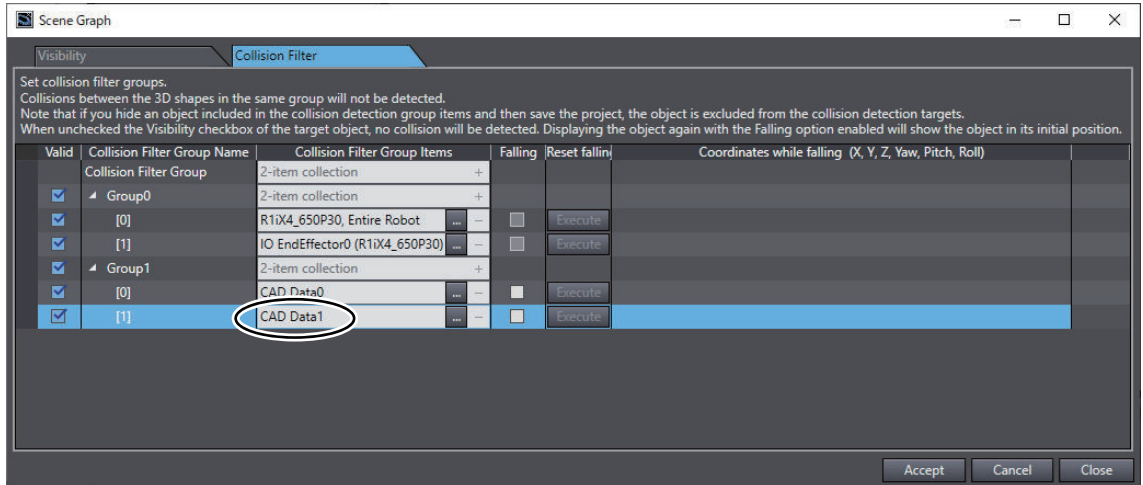

- 15** Check that the **Valid** check boxes are all selected. If there is a check box not selected, click it to select.

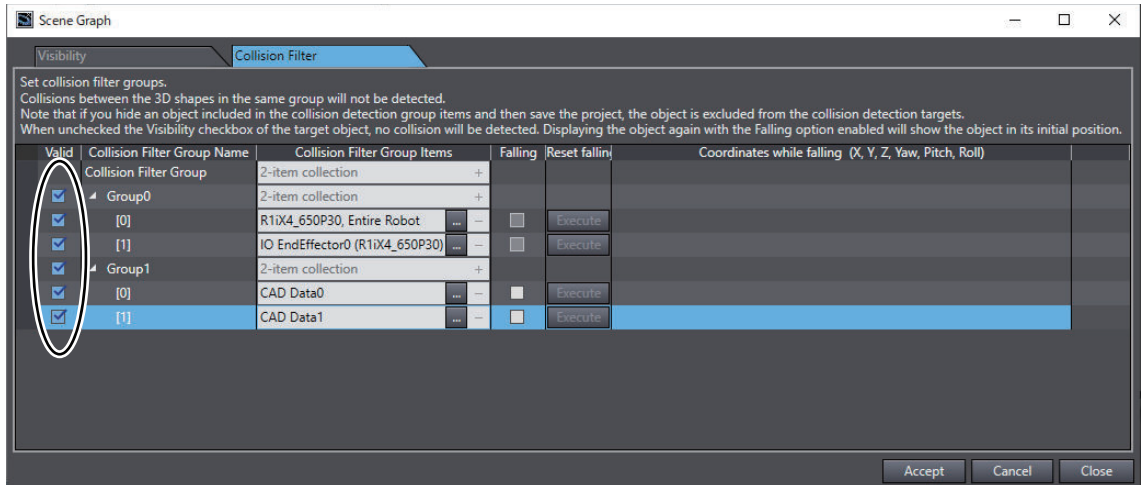

- 16** Click the **Accept** button.  
A collision filter configuration is saved.

- 17** Click the **Close** button in the **Scene Graph** dialog box.

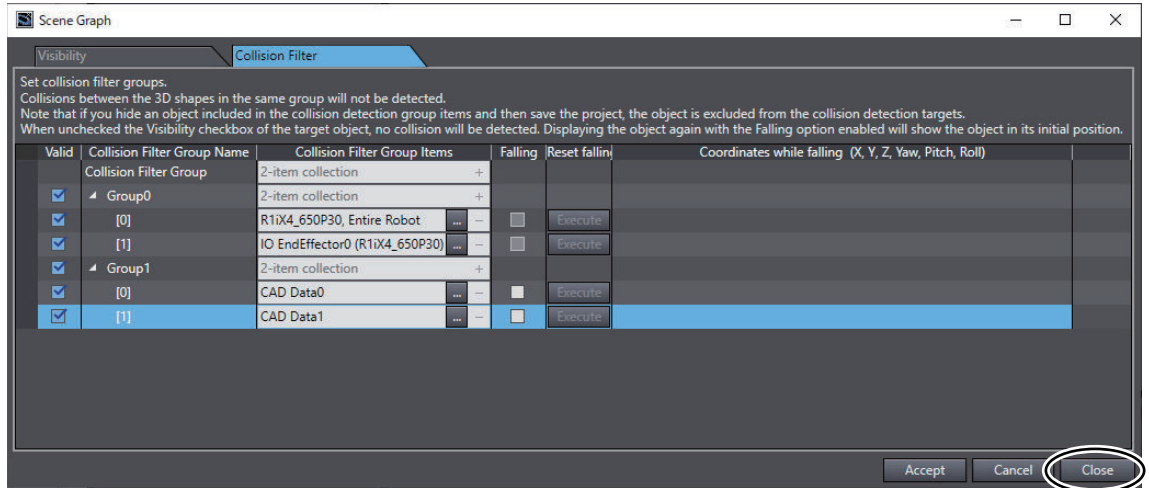

The **Scene Graph** dialog box is closed.

Now, the settings for checking for collision between the robot and Conveyor A, and between the robot and Conveyor B have been completed.

### 4-3-6 Creating a Pack Manager Sample

This section describes the procedure to create a Pack Manager sample.  
The operations flow is as follows.

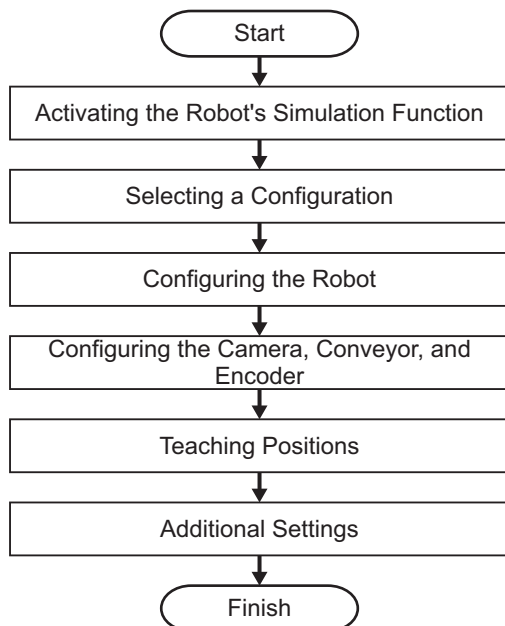

## Enabling Robot Simulation Function

Enable the simulation function of the Sysmac Studio.

To simulate the operation of the robot, open the project file in EMULATION mode.

If you want to know whether the project file opened on the Sysmac Studio is in EMULATION mode or not, check the status bar on the main window. When you see **[Emulation Mode] Access Level: Engineer** on the status bar, the project is opened in EMULATION mode.

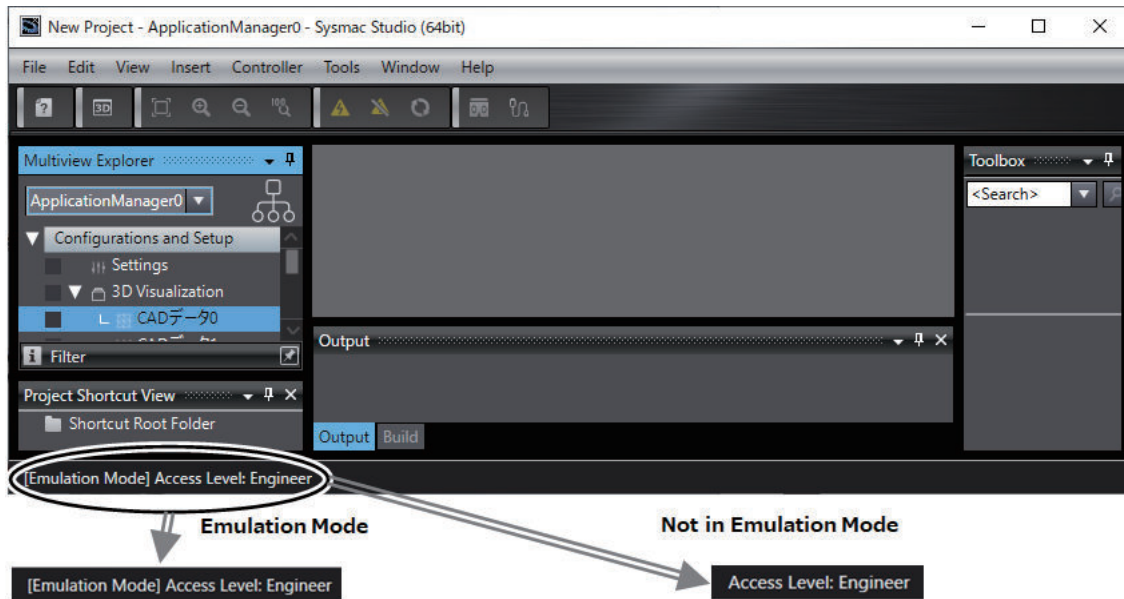

If the project is opened in a different mode, click the **Enable emulation mode** icon on the toolbar to change to EMULATION mode.



- 1 In the Multiview Explorer, select **new\_Controller\_0** from the device list.

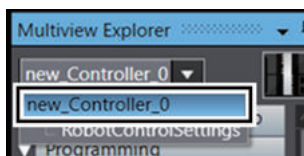

- 2 Select **Run** from the **Simulation** menu.  
The screen below is displayed while the simulator is starting.

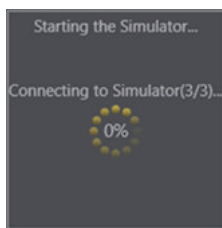

After this screen is closed, the lower part of the toolbar in the main window turns yellow-green.

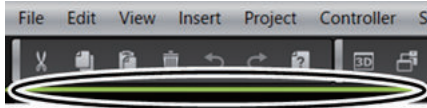

## Selecting a Configuration

Select the configuration of the robot and peripheral devices.

Decide whether to use the pallet function, belt encoder, and camera in pick-and-place operation.

Details of the features and information on how to select them are given below.

In this guide, pick operation uses the belt encoder and camera, and the pallet function is not used.

Letter	Operation	Function	Content
A	Pick	Pallet	You can choose whether the pick position is considered a palette or not. If this function is selected, a workpiece can be picked from each row/column of the palette.
B	Pick	Encoder	You can choose whether to use the belt encoder for adjusting the pick position. Select this to pick a workpiece that flows on the belt conveyor.
C	Pick	Camera	You can choose whether to use the camera for adjusting the pick position. Select this to pick a workpiece on the conveyor and the posture of the workpiece is not constant.
D	In conveyance	Camera	You can choose whether to adjust the placing position by using the camera in an upward-facing position. Select this to place workpieces in the same orientation on the unloading side conveyor.
E	Place	Pallet	You can choose whether the placing position is considered a palette or not. If this function is selected, workpieces can be placed in each row/column of the palette.
F	Place	Encoder	You can choose whether to use the belt encoder for adjusting the placing position. Select this to place workpieces in an evenly spaced alignment on the unloading side conveyor.
G	Place	Camera	You can choose whether to use a camera for adjusting the placing position. Select this to place workpieces to fit a particular pattern.

The table below lists the pick configurations.

A, B, and C in the table above represent pick operations.

Selections			Configuration name
A	B	C	
Yes	Yes	Yes	No configuration available Create a Pack Manager sample and change the Process Manager settings by referencing the <i>Sysmac Studio Robot Integrated System Building Function with Robot Integrated CPU Unit Operation Manual (Cat. No. W595)</i> .
Yes	Yes	None	At a pallet located by a belt latch sensor
Yes	None	Yes	No configuration available Create a Pack Manager sample and change the Process Manager settings by referencing the <i>Sysmac Studio Robot Integrated System Building Function with Robot Integrated CPU Unit Operation Manual (Cat. No. W595)</i> .
Yes	None	None	At a fixed pallet
None	Yes	Yes	On a belt located with a camera

Selections			Configuration name
A	B	C	
None	Yes	None	With a fixed mounted camera
None	None	Yes	With a belt latch sensor
None	None	None	At a fixed position

The table below lists the configurations for correction after picking.  
D in the table above represents operation after picking.

Selections	Configuration name
D	
Yes	No, do not refine the position of the part.
None	Yes, refine the position of the part using a camera.

The table below lists the configurations for placing.  
E, F, and G in the table above represent placing operations.

Selections			Configuration name
E	F	G	
Yes	Yes	Yes	No configuration available After creating the Pack Manager sample, refer to <i>Sysmac Studio Robot Integrated System Building Function with Robot Integrated CPU Unit Operation Manual (Cat. No. W595)</i> and change the Process Manager settings.
Yes	Yes	None	At a pallet located by a belt latch sensor
Yes	None	Yes	No configuration available After creating the Pack Manager sample, refer to <i>Sysmac Studio Robot Integrated System Building Function with Robot Integrated CPU Unit Operation Manual (Cat. No. W595)</i> and change the Process Manager settings.
Yes	None	None	At a fixed pallet
None	Yes	Yes	On a belt located with a camera
None	Yes	None	With a fixed mounted camera
None	None	Yes	With a belt latch sensor
None	None	None	At a fixed position

- 1 Click **new\_Controller\_0** from the device list in the Multiview Explorer of the Sysmac Studio.

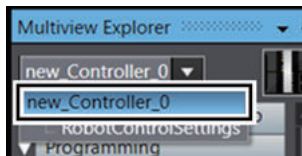

- 2 Select **Application Sample - Pack Manager Sample** from the **Insert** menu on the main window of the Sysmac Studio.



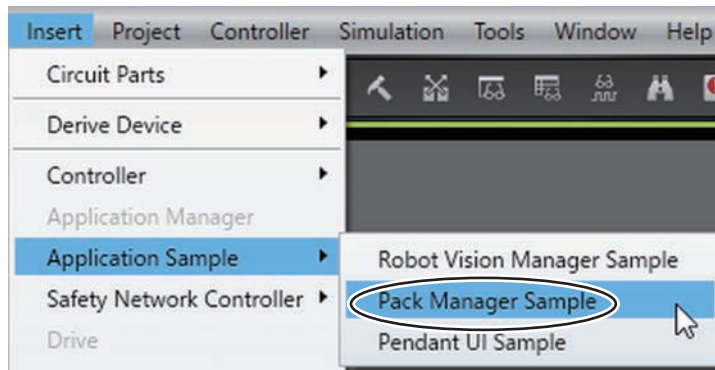

### Precautions for Correct Use

If the configuration of the **Pack Manager Sample** is not completed until the last teaching or it is canceled, you need to start over from the first step of the flow to create the **Pack Manager Sample**. If **ApplicationManager1** has been registered in the device list of the Multiview Explorer through the execution of the **Pack Manager sample**, delete **ApplicationManager1** once with the Delete key and start the procedure again.

**Pick and Place Sequence: Select Configuration** dialog box is displayed.

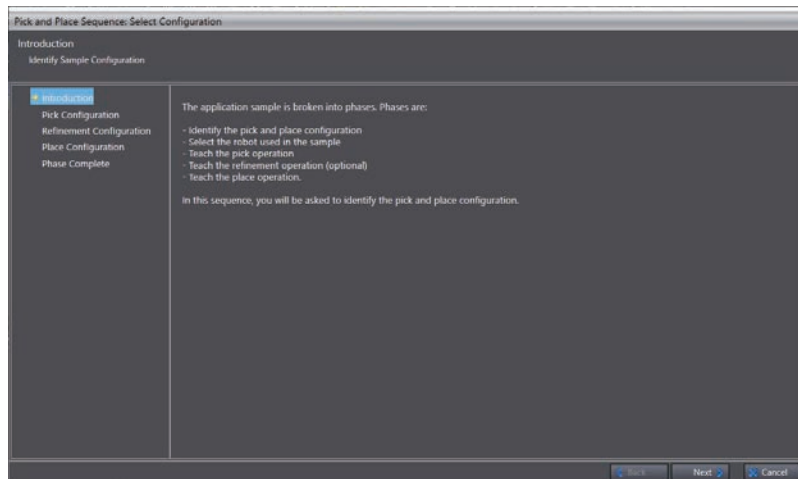

**3** Click the **Next** button at the bottom right of the dialog box.

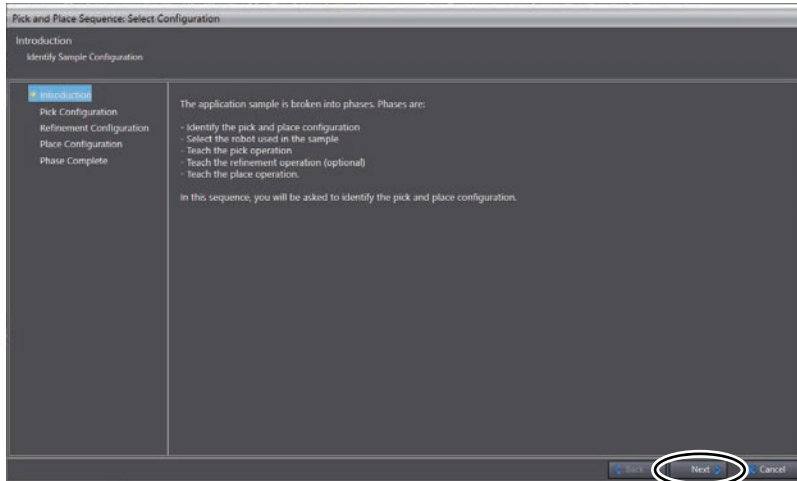

**4** Select **On a belt located with a camera** and click the **Next** button.

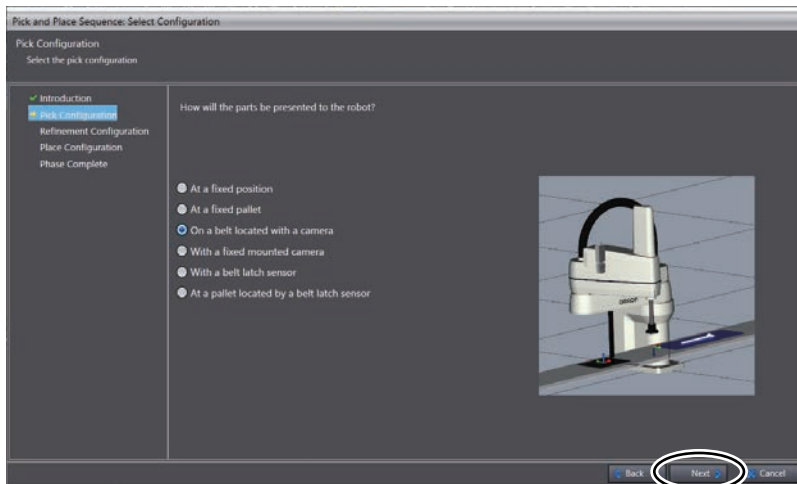

**5** Select **No**, do not refine the position of the part. and click the **Next** button.

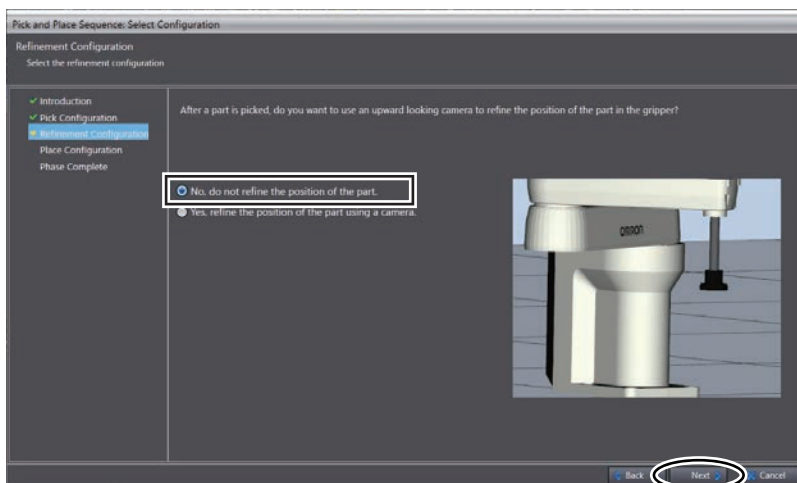

**6** Select **At a fixed position** and click the **Next** button.

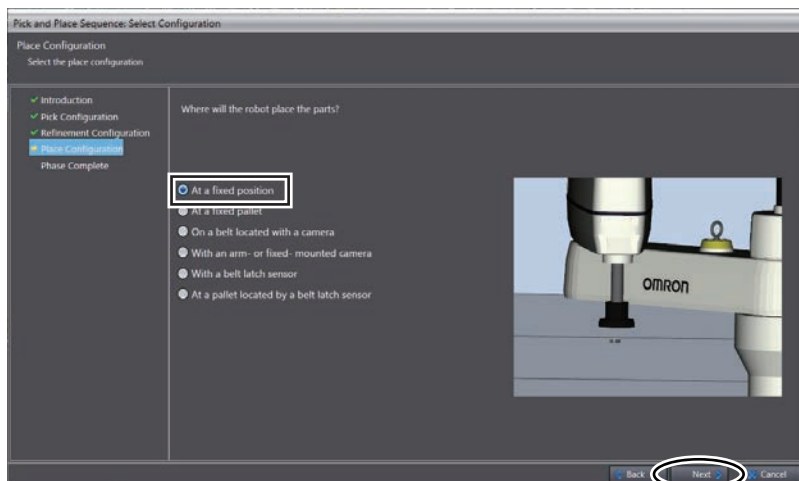

**7** Click the **Finish** button.

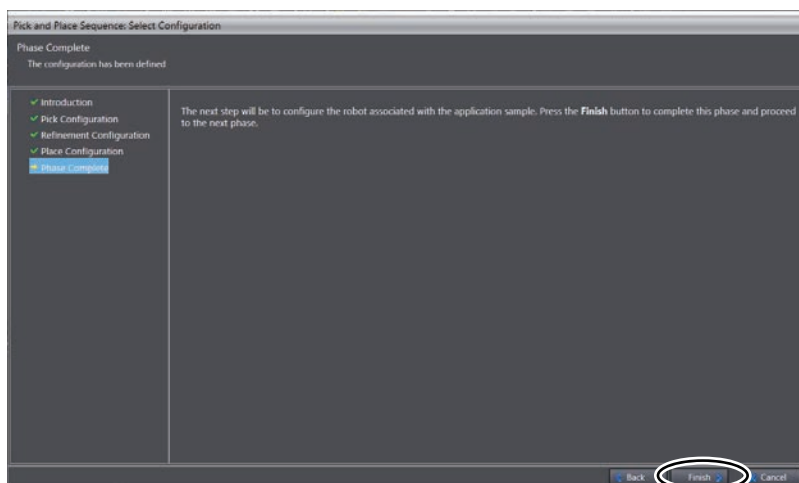

The dialog box closes and **Pick and Place Sequence: Phase 1/3 - Select Robot** dialog box is displayed.

## Configuring the Robot

In this section, select the robot and end effector to use for the Pack Manager and teach the wait positions.

**1** In the **Introduction** page, click the **Next** button.

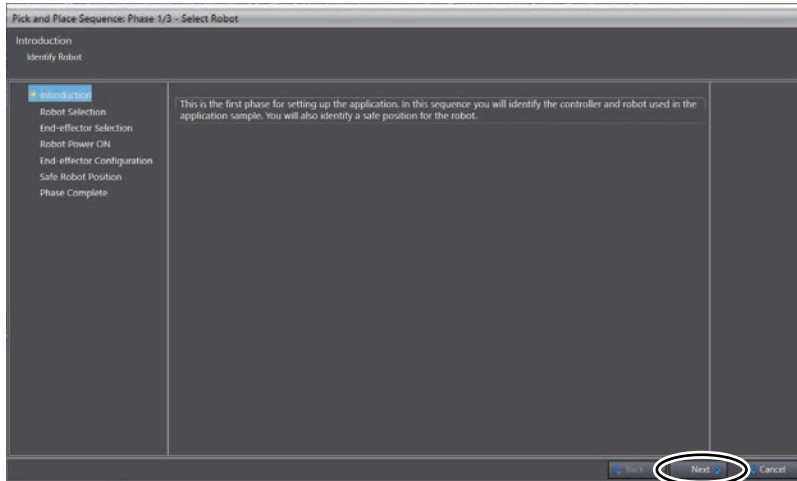

- 2** In the **Select Robot** page, confirm that **R1iX4\_650P30** is selected and click the **Next** button.

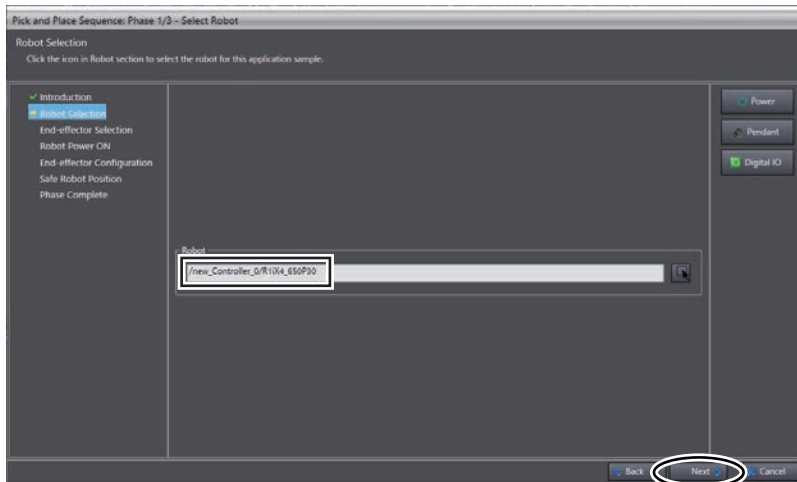

- 3** In the **Select the End-Effector** page, confirm that **IO EndEffector0** is selected and click the **Next** button.

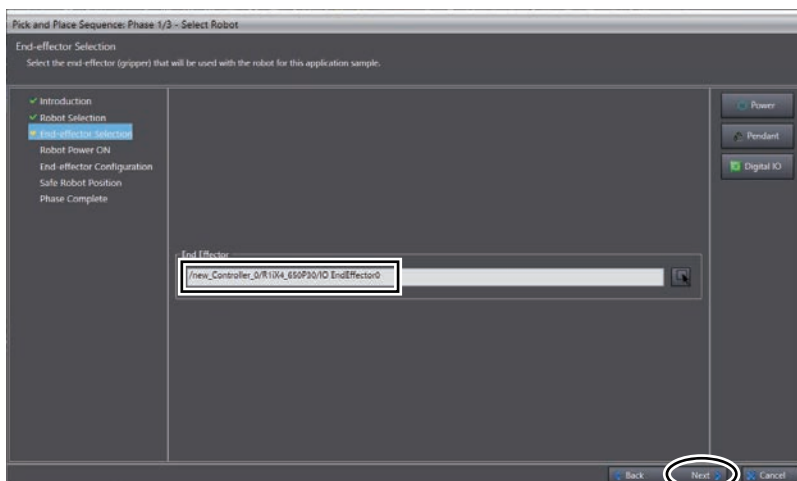

- 4 The **Robot Power ON** dialog box may appear. In that case, click the **Power** button and select the **Next** button at the bottom right of the dialog box.

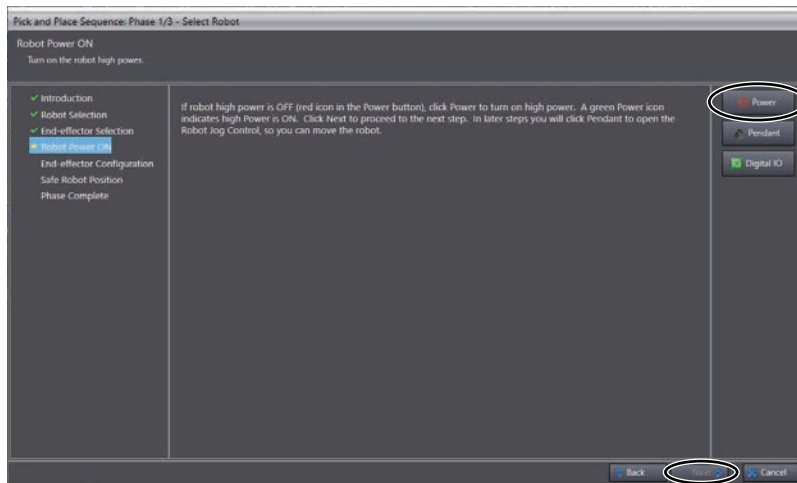

- 5 Register the signal number of the robot built-in I/Os which are used to control the vacuum pad. Enter the value **-4001** to **Open** and **4001** to **Close** in the **Outputs** field of the **Digital I/O Signals**. They are Open signals of the solenoid valve that was allocated in *V+Digital I/O* on page 4-7.

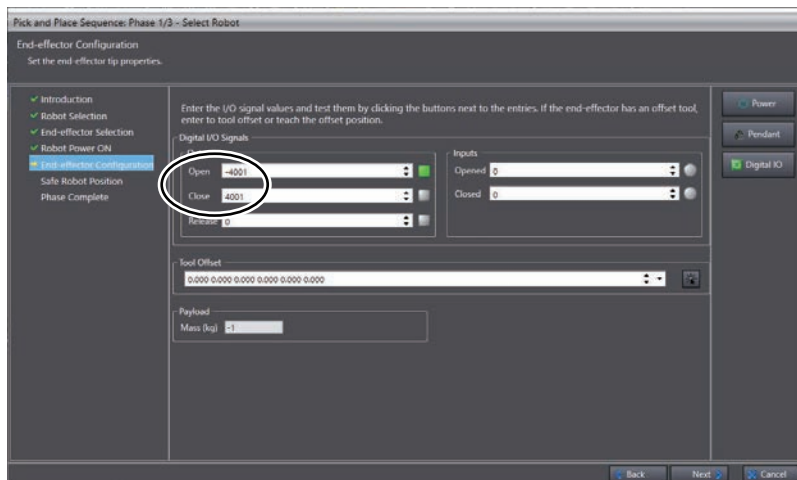

- 6 Set 50mm as the offset value from the TCP to the vacuum pad tip in the Z direction. Enter *0.000 0.000 50.000 0.000 0.000 0.000* in the **Tool Offset**.

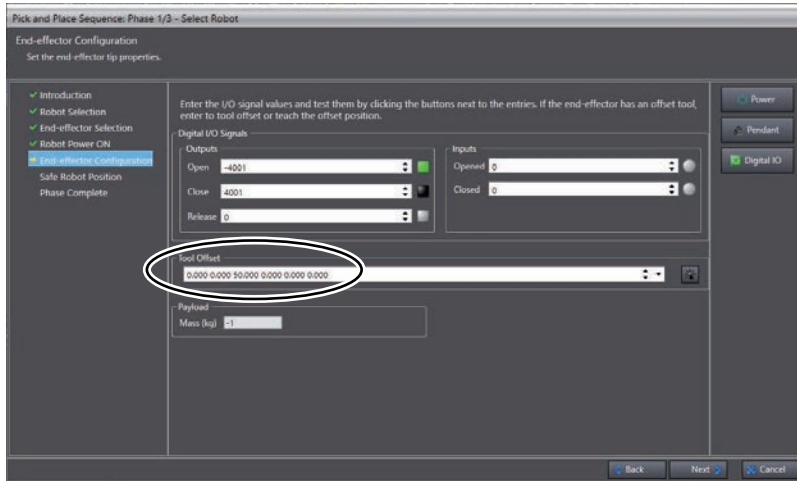

Click the Next button at the bottom right of the dialog box.

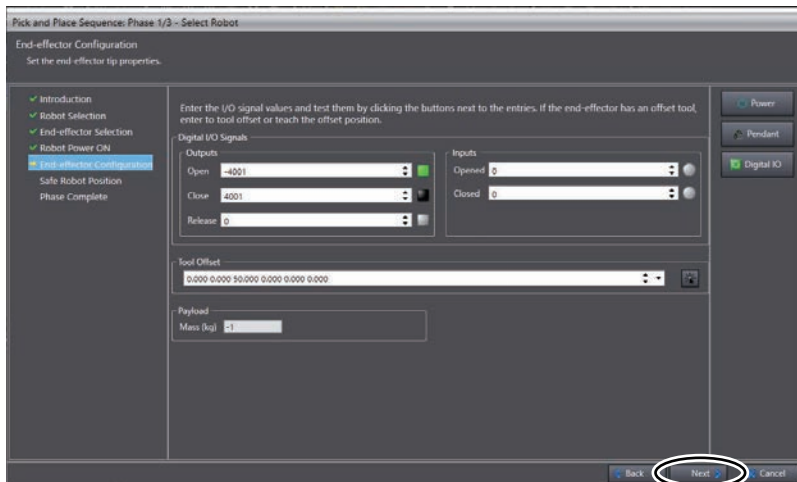

- To temporarily determine the wait position, operate the robot on the **3D Visualizer**. Set the robot's wait position above an approximate pick position on the conveyor.

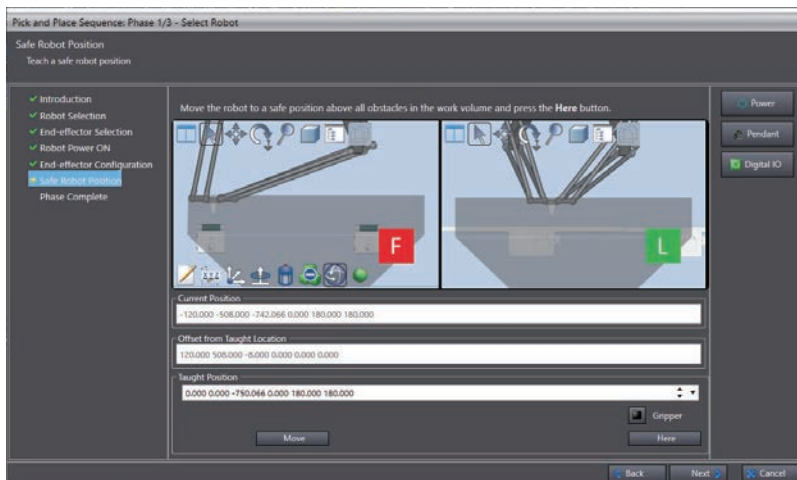



### Precautions for Correct Use

If the wait position is specified out of the belt window set in *Configuring the Camera, Conveyor, and Encoder* on page 4-65, a belt window violation error will occur during tracking and the tracking will fail. Assume the approximate position of the belt window, and determine the wait position above the position that fits within the belt window.

After completing the tentative setting of the wait position, proceed to the next step.

- 8 Click the **Here** button at the bottom right of the dialog box.

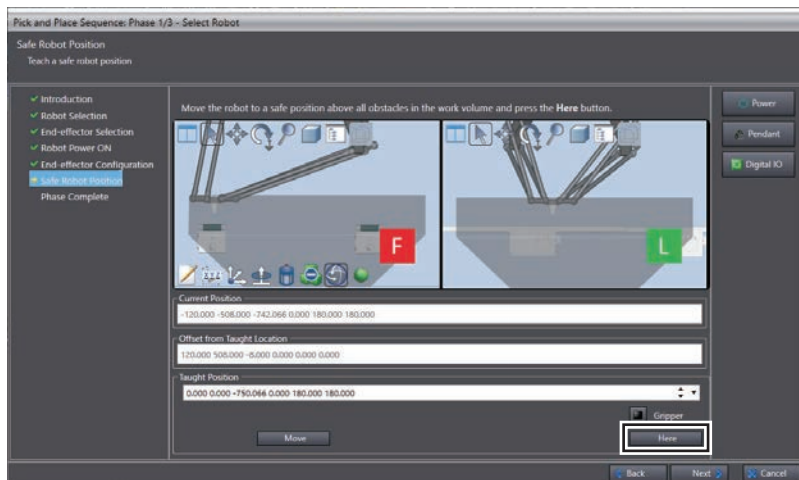

The value in the **Taught Position** is changed to the value of the current position.

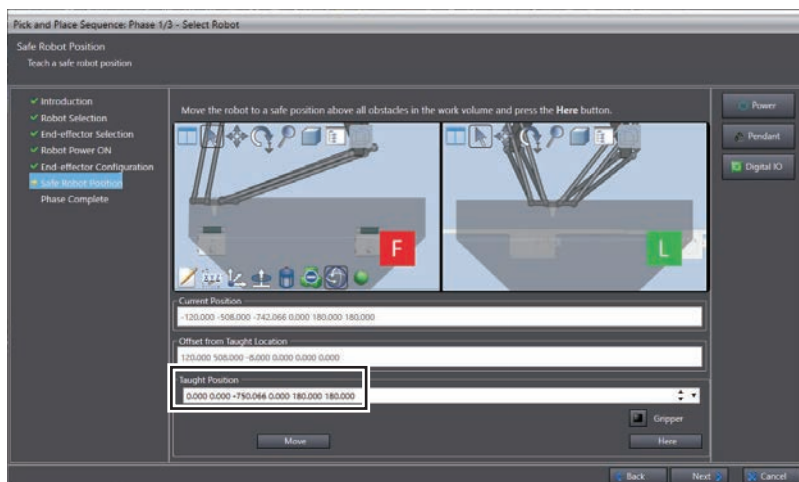

- 9 Click the **Next** button at the bottom right of the dialog box.

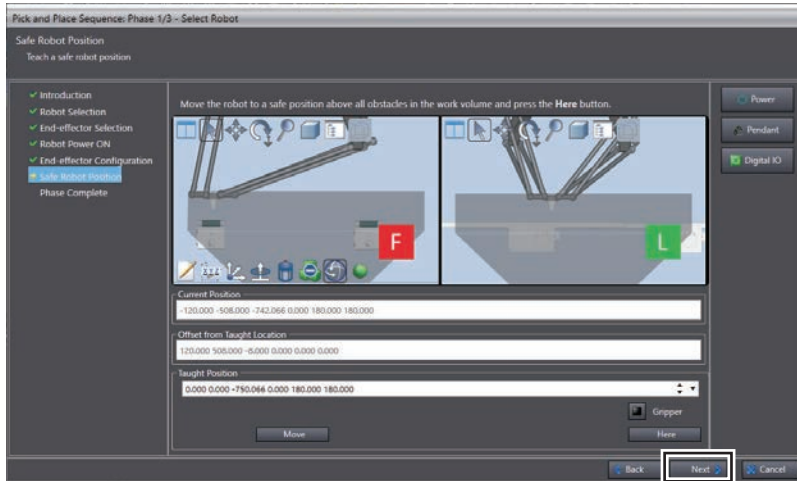

**10** Click the Finish button at the bottom right of the dialog box.

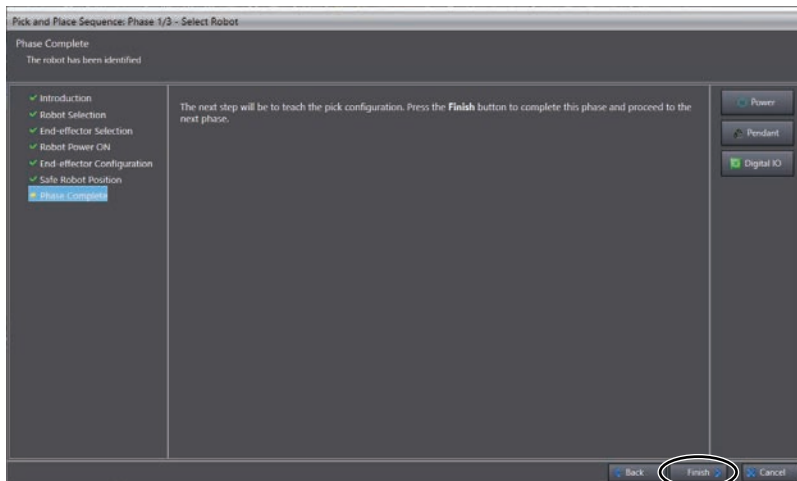

**Pick and Place Sequence: Phase 1/3 - Select Robot** dialog box closes and **Pick Configuration** dialog box pops up.

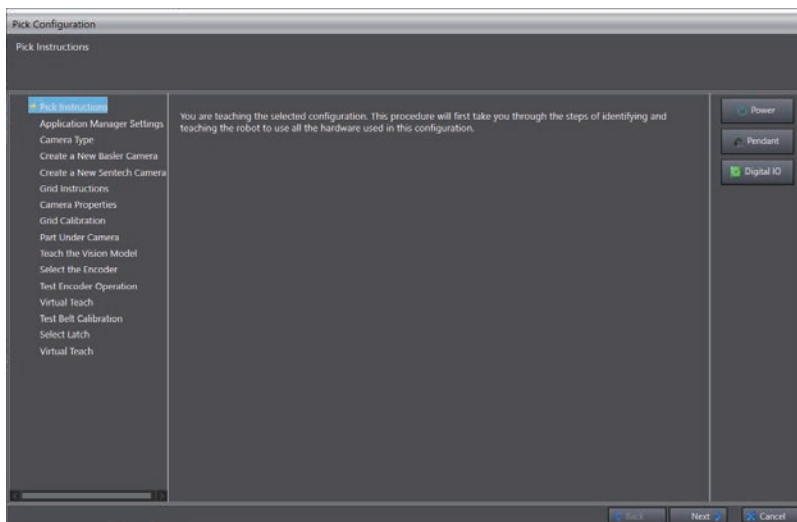



## Configuring the Camera, Conveyor, and Encoder

- 1 Click the **Next** button at the bottom right of the dialog box.

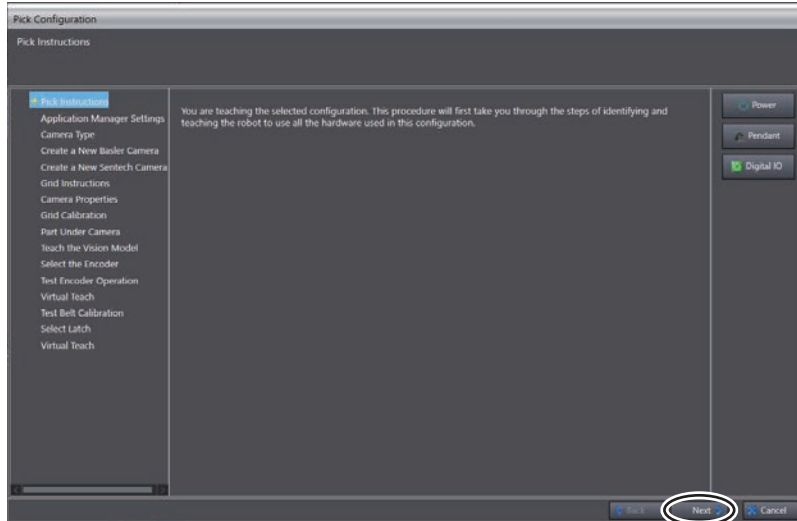

- 2 In the **Application Manager Settings** dialog box, confirm that the **IP Address** is set to **127.0.0.1** and click the **Next** button.

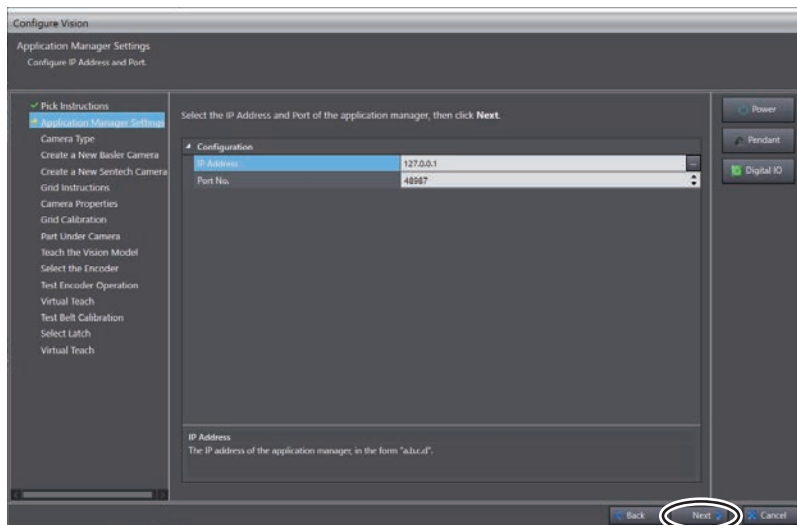

- 3 In the system configuration of this guide, the 24114 Basler camera is used. Make sure that **Basler Camera** is selected and click the **Next** button at the bottom right of the dialog box.

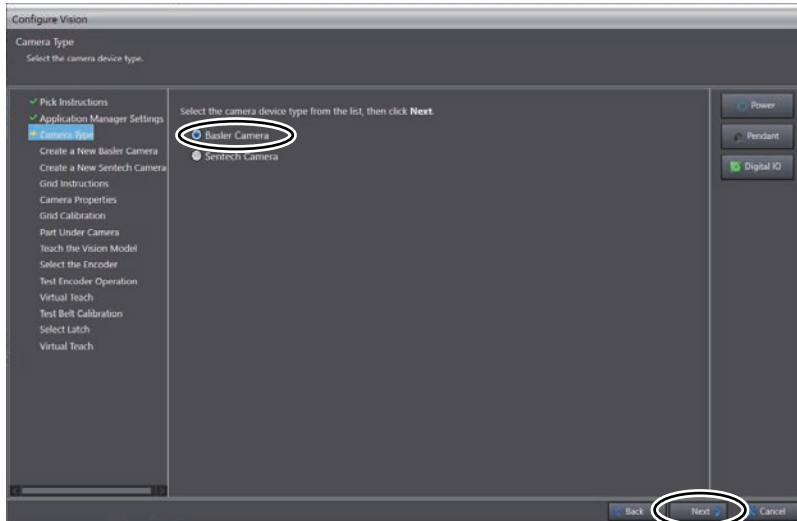

- 4** Click the **Next** button at the bottom right of the dialog box.

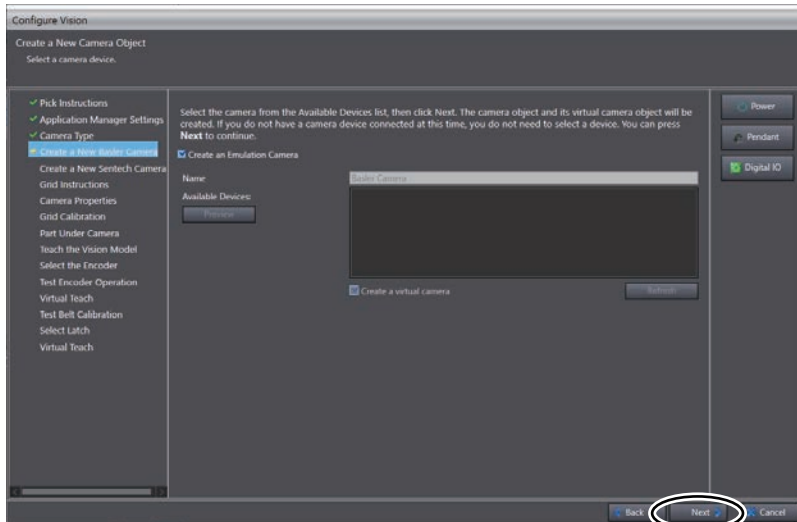

- 5** Select a row for the encoder **0** from the list as determined in this guide. Encoder No. 1 of the wiring connector corresponds to encoder **0** on this dialog box. For information on wiring, refer to the *4-4-8 Wiring the Robot and Encoder* on page 4-98.

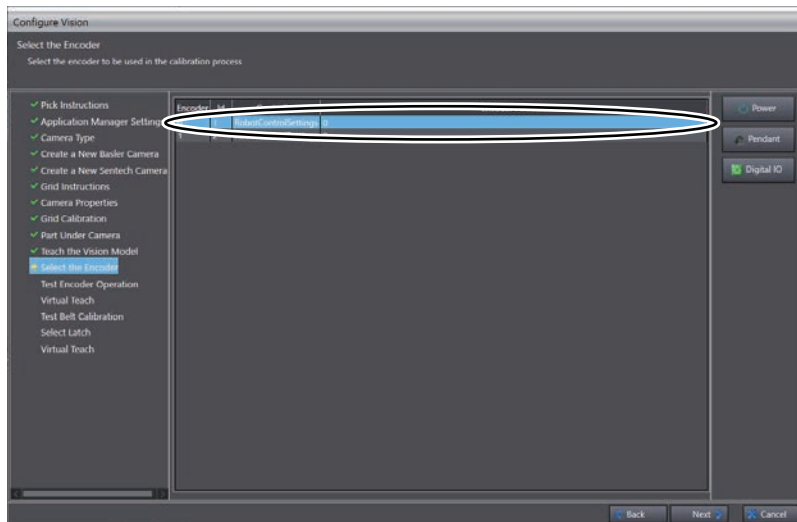

- 6** Click the **Next** button at the bottom right of the dialog box.

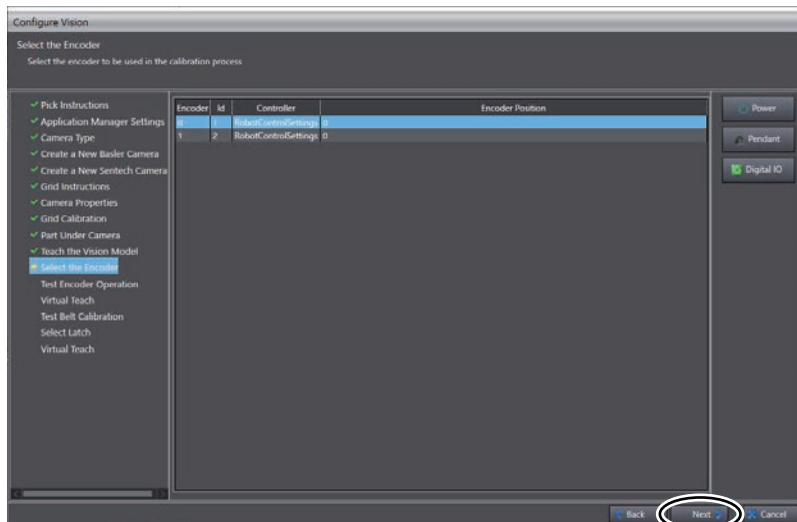

- 7** Allocate the operation signals of the conveyor, assigned by V+ Digital I/O Settings in this guide. Enter values in the **On/Off**, **Fast/Slow**, and **Reverse/Forward** fields in the center of the window. Set 2001 to **On/Off**, 2002 to **Fast/Slow**, and 2003 to **Reverse/Forward**. For allocation of V+ digital I/Os, refer to *V+Digital I/O* on page 4-7.

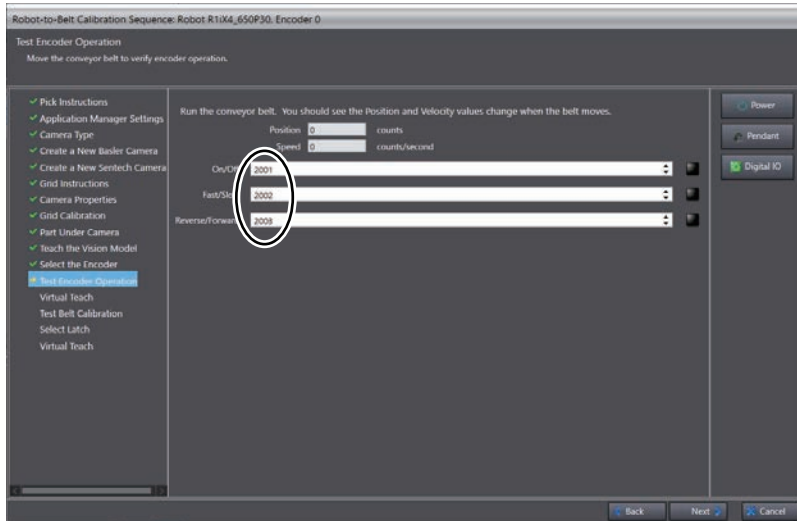

8 Click the **Next** button at the bottom right of the dialog box.

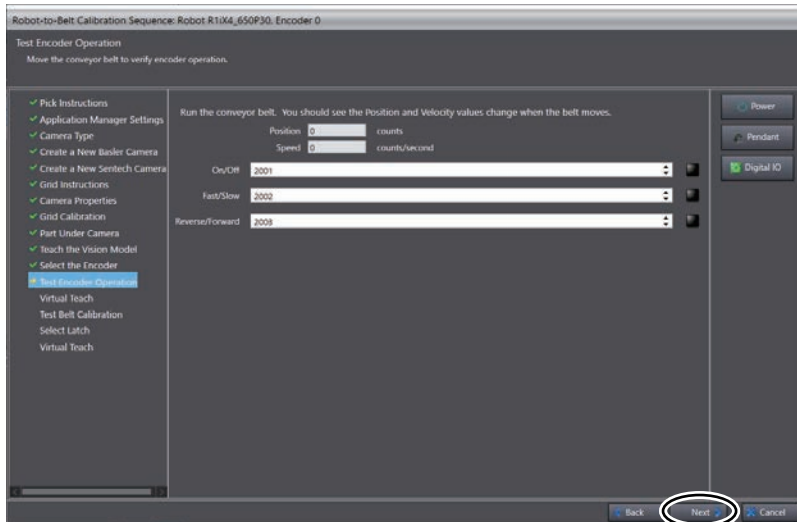

9 Determine the **position of the conveyor, Upstream Limit, Pick Limit, Downstream Limit, and Belt Width.**

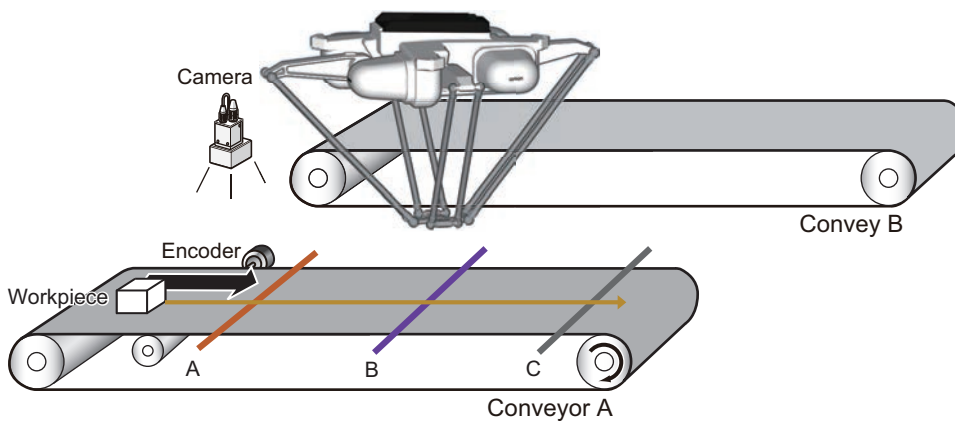

Letter	Item	Description
A	Upstream Limit	The limit position upstream of the conveyor to make a pick operation. The robot does not pick at the conveyor position upstream from the <b>Upstream Limit</b> .
B	Pick Limit	The reference limit position downstream of the conveyor to make a pick operation. When the placement is completed, the robot specifies the next workpiece to pick and calculates the pick position. At that time, workpieces that exist downstream from the <b>Pick Limit</b> are excluded from the pick target.
C	Downstream Limit	The limit position downstream of the conveyor to make pick operation. The robot does not pick at the conveyor position downstream from the <b>Downstream Limit</b> .

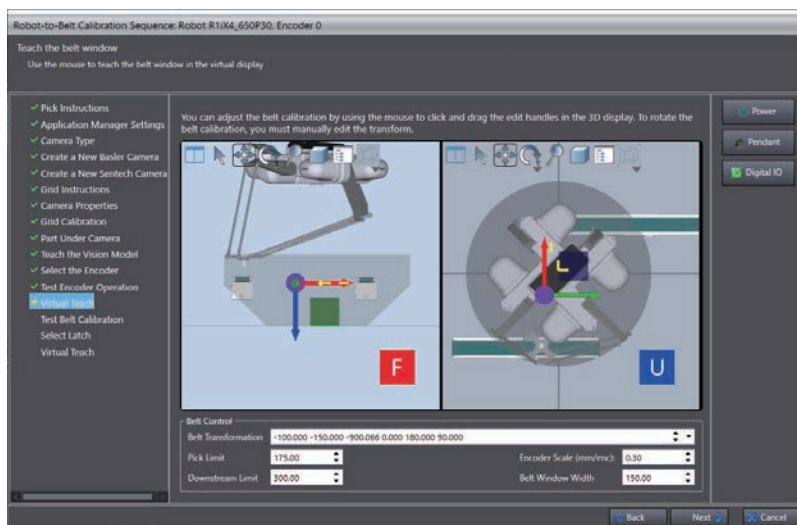

You can set the points by a drag and drop operation on the 3D Visualizer or by directly entering data in numeric entry fields of **Belt Control**. Set the points in either way.

- Dragging and Dropping on the 3D Visualizer

Refer to *A-2 How to Use 3D Visualizer* on page A-21 and the *Sysmac Studio Robot Integrated System Building Function with IPC Application Controller Operation Manual (Cat. No. W621)* for operation procedure of the 3D Visualizer.

The conveyor can be moved by dragging and dropping the green, red, and blue arrows.

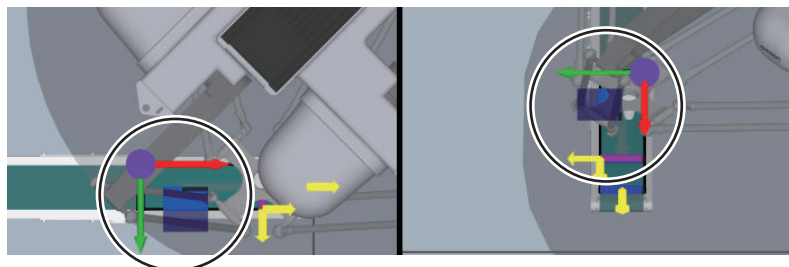

The **Upstream Limit** is the position indicated by the purple point and the green arrow (origin of **Belt Transformation** and Y-axis).

The **Pick Limit** is indicated by a purple line and the **Downstream Limit** by a blue line. The **Pick Limit** and **Downstream Limit** can be moved by dragging and dropping the yellow arrow.

Position them within the operating range of the robot.

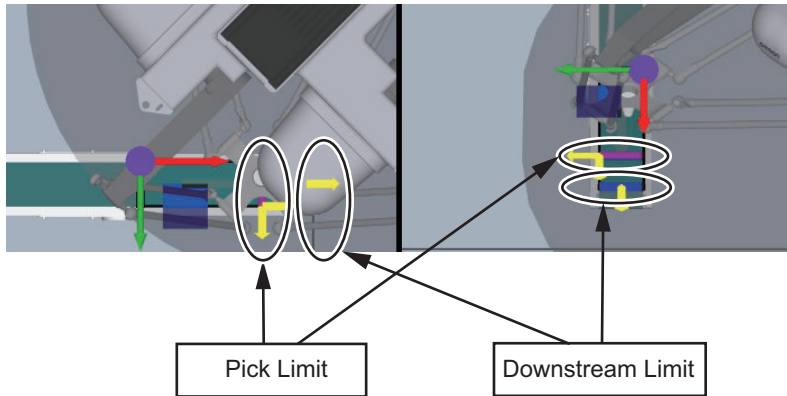

The belt width can be changed with the yellow arrow indicated in the frame in the figure below.

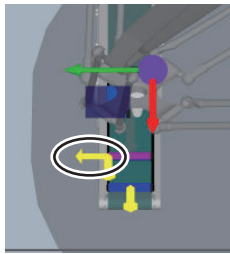

- Directly entering data in the fields of **Belt Control**

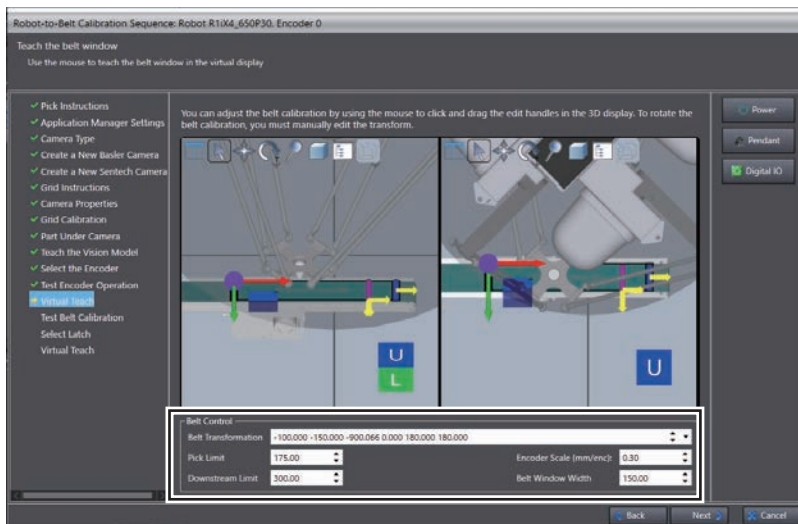

The **Upstream Limit** is the same point as the origin of Belt Transform. Therefore, enter offset distance from the world coordinate in the input fields of **Belt Transformation**.

Enter relative distance from the **Upstream Limit** in mm to **Pick Limit** and **Downstream Limit** input fields.

Input **Belt Width** to the **Belt Window Width** input field in mm.

Enter the value of encoder scale (mm/encoder) in the **Encoder Scale** input field.

- 10** Click the **Next** button at the bottom right of the dialog box.

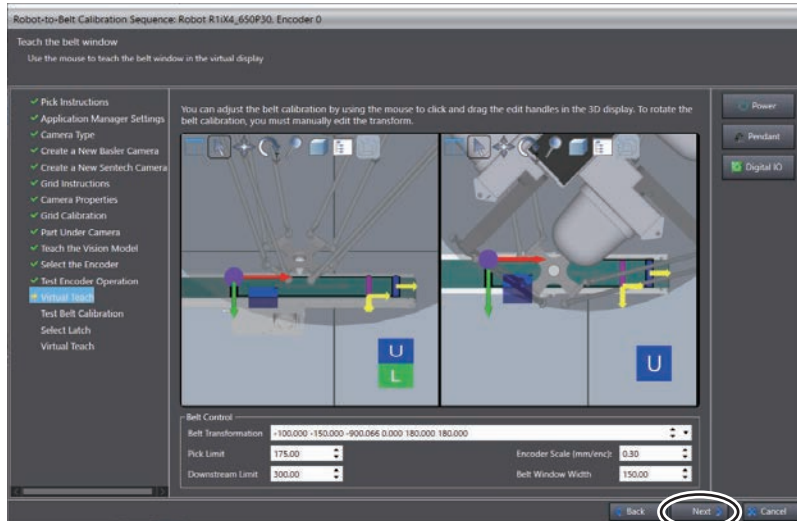

- 11** Click the **ON/OFF** button to turn it ON, and then click the **Start Tracking** button to check that the robot can successfully track along the conveyor. If no problem was found, click the **Next** button at the bottom right of the dialog box.

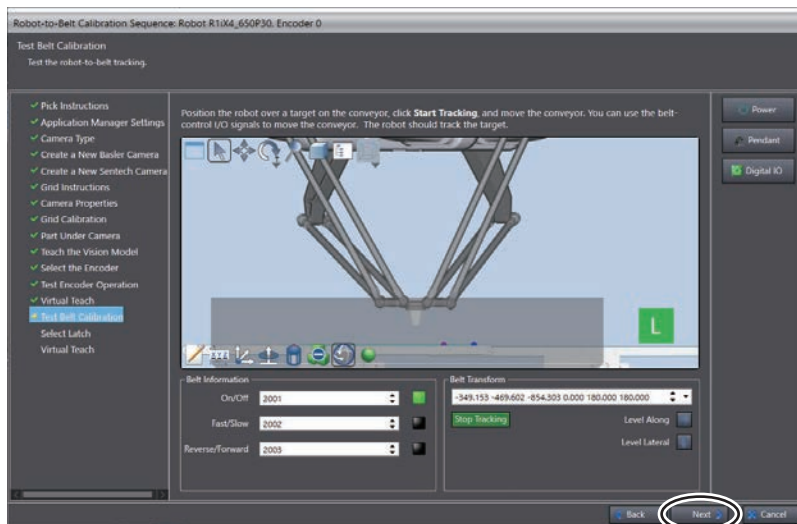

- 12** Make sure that the right latch number has been selected, and then click the **Next** button.

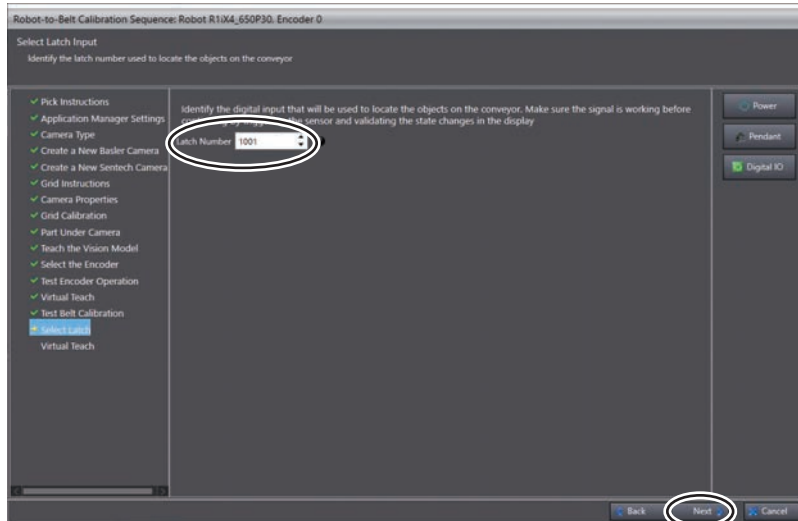

**13** Click the **Finish** button at the bottom right of the dialog box.

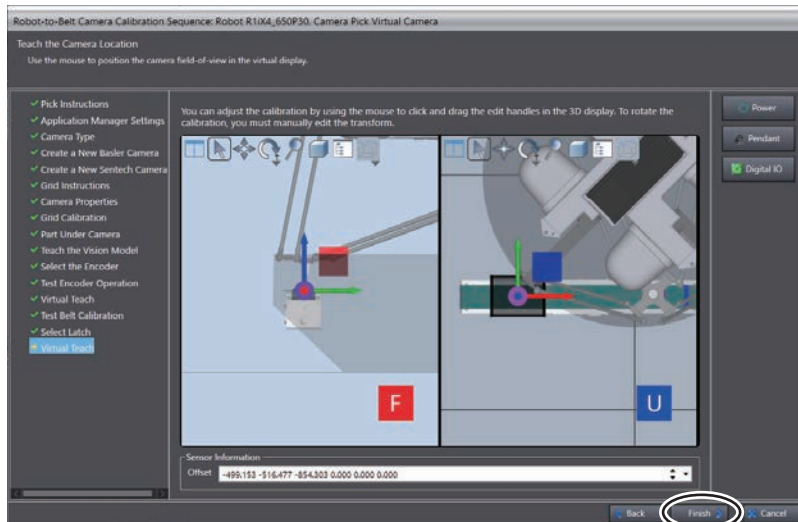

## Teaching Positions

### ● Teaching Robot's Idle Positions

**1** Click the **Move** button at the lower part of the dialog box.



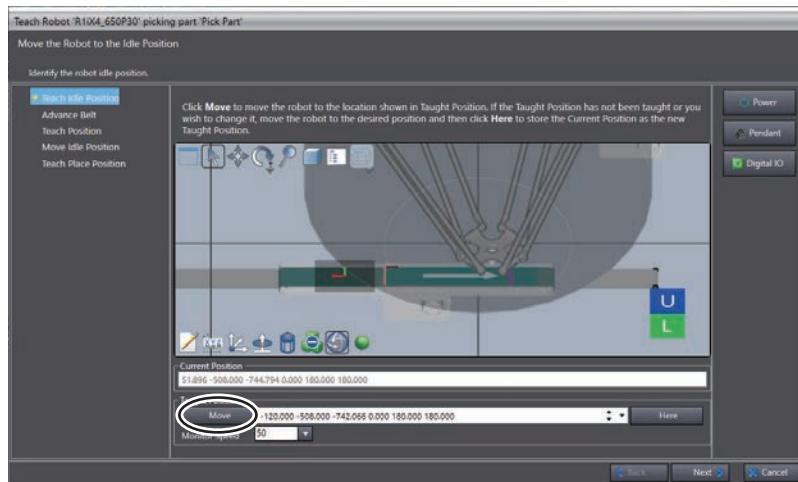

The robot moves to the robot's idle position.

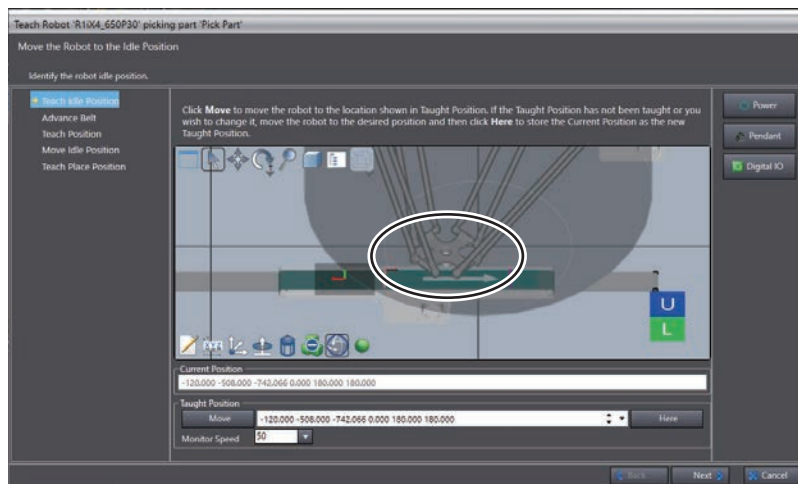

- 2 Adjust it to a position from where the robot can be moved to the pick and place positions in linear interpolation. After the adjustment, click the **Here** button.
- 3 Click the **Next** button at the bottom right of the dialog box.

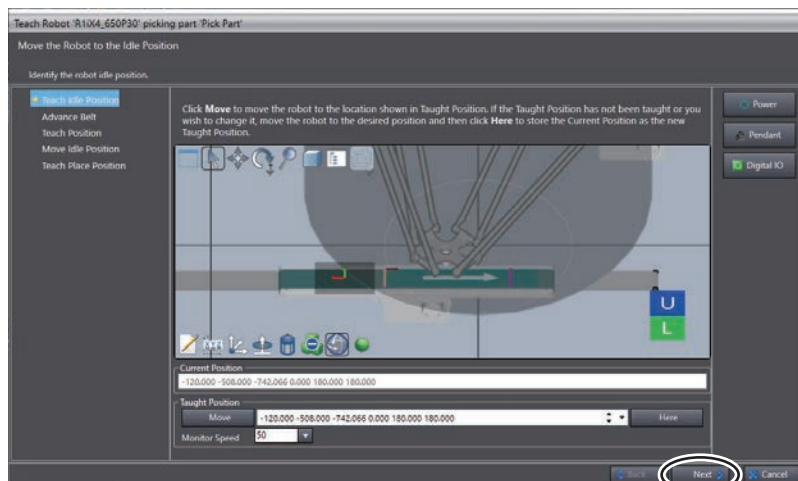

- 4 Move the belt forward to a position where the robot can touch the part.

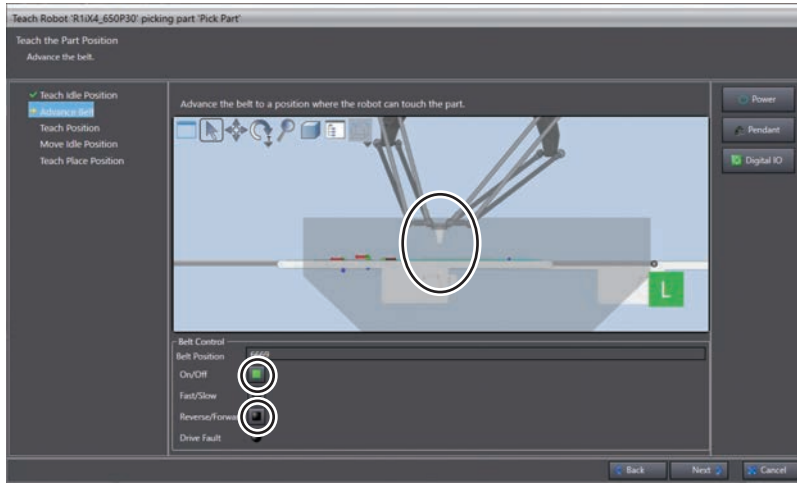

- 5 Click the **Next** button.

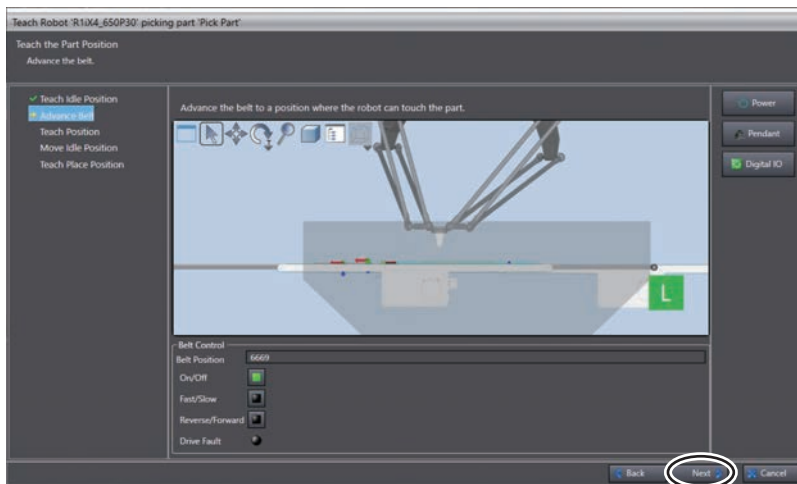

● **Teaching Pick Position, Approach Height, and Depart Height**

- 1 Click the buttons for **ON/OFF** and **Reverse/Forward** in the **Belt Control** box at the lower part of the dialog box to move the green workpiece on the conveyor. After that, once stop the workpiece within the operating range of the robot and in the belt window.

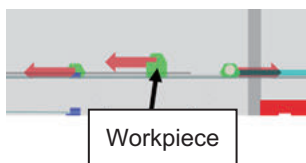

- 2 Click the **Next** button at the bottom right of the dialog box.

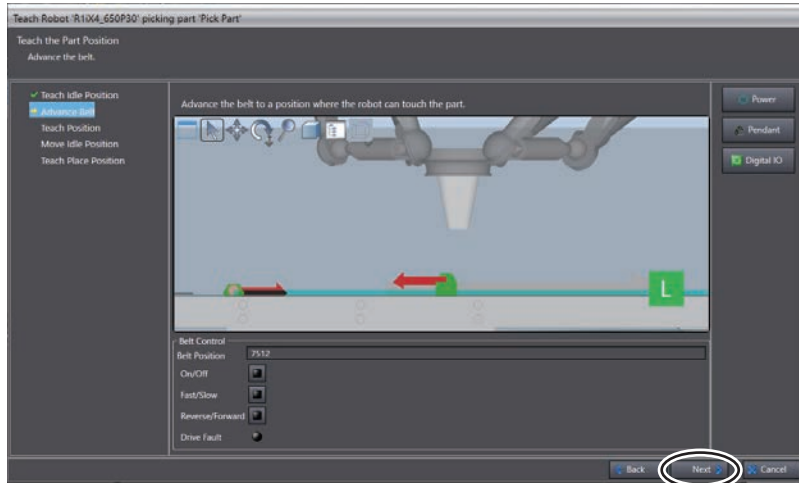

3 Click the **Move** button at the lower part of the dialog box.

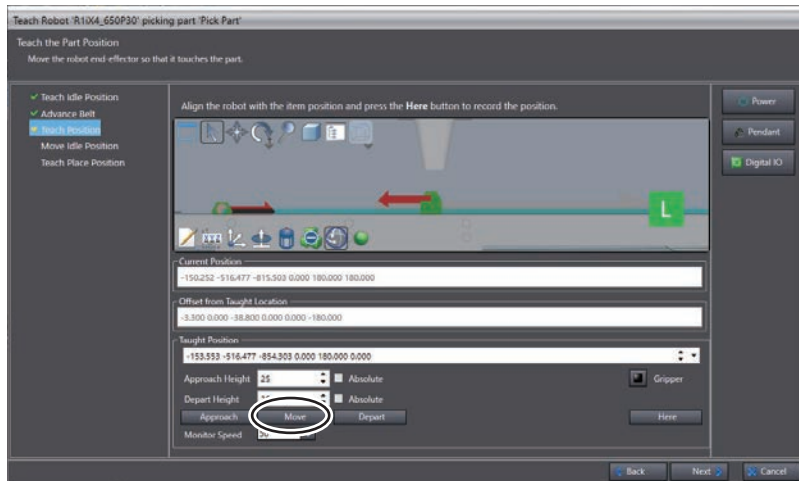

4

The robot moves so that the tool center point is at the lowermost part of the workpiece on the conveyor.

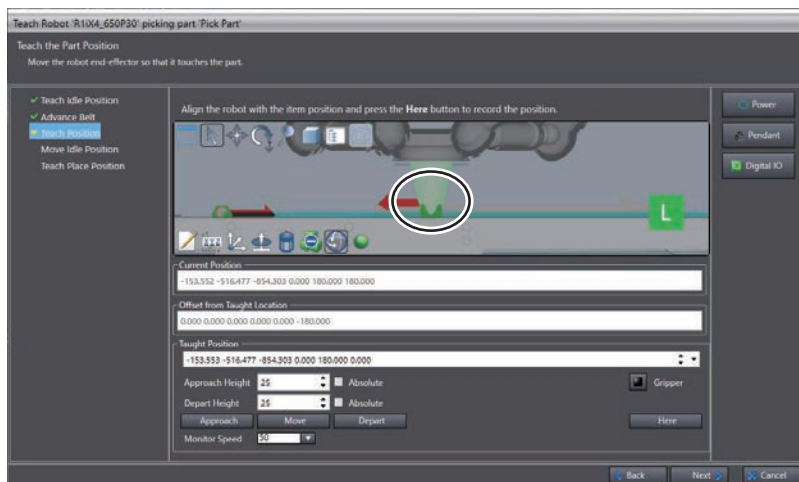

4 Move the robot in the Z-axis direction so that the end-effector tip is on the top of the workpiece.

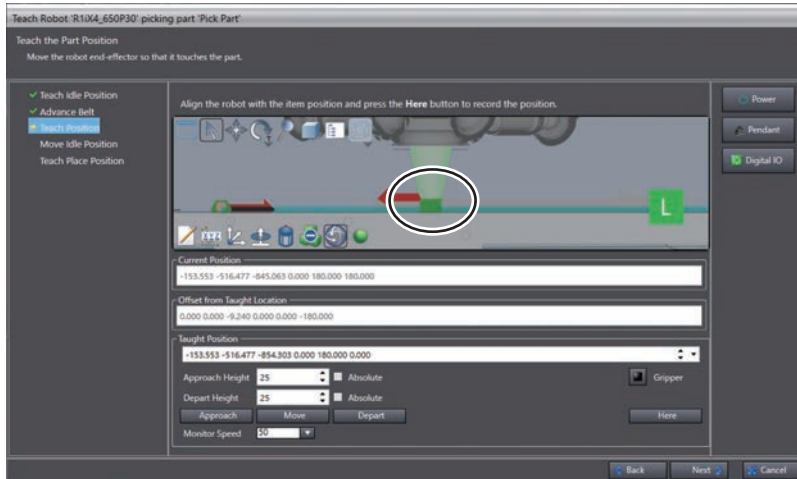

5 Click the **Here** button.

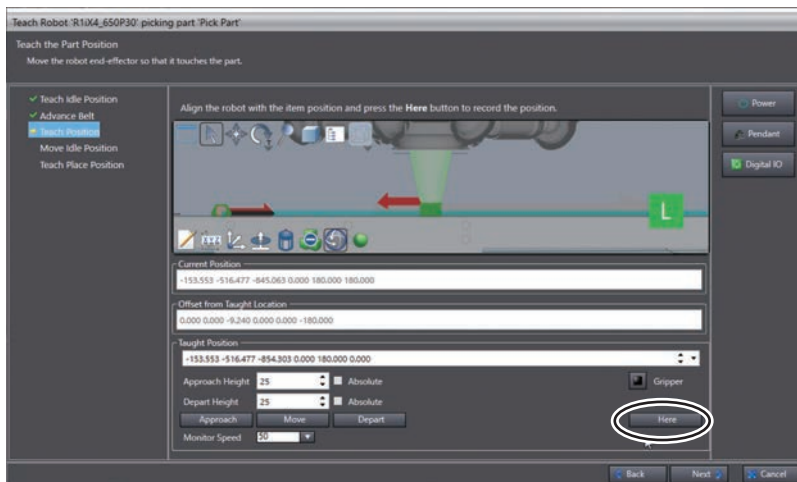

6 Enter the elevation distance that the robot moves to or moves from the workpiece pick-up position in the **Approach Height** and **Depart Height** input fields of **Taught Position**.

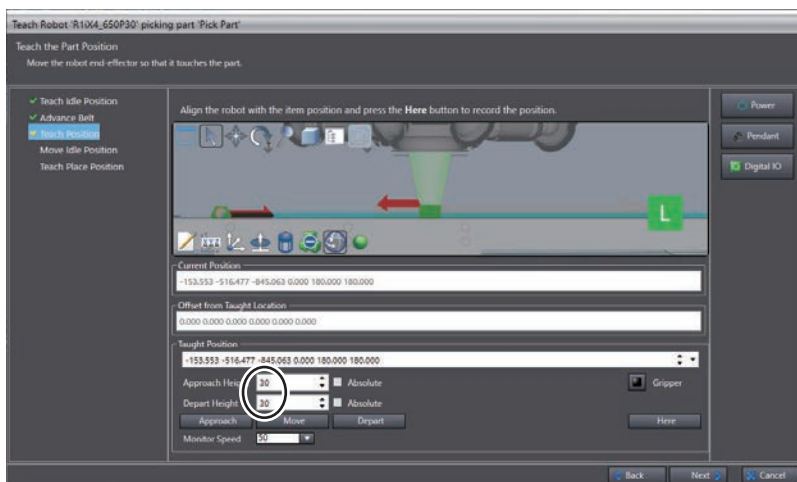

Check the operation by moving the robot to the set heights by pressing the **Approach** and **Depart** buttons.

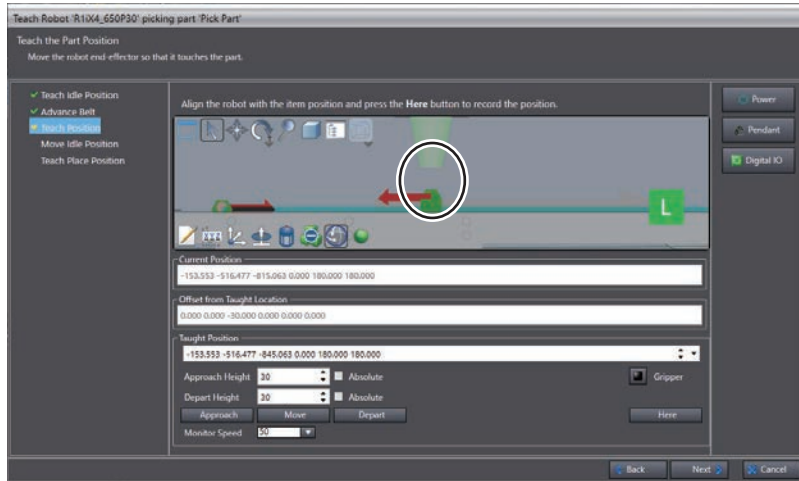

7 Click the **Next** button at the bottom right of the dialog box.

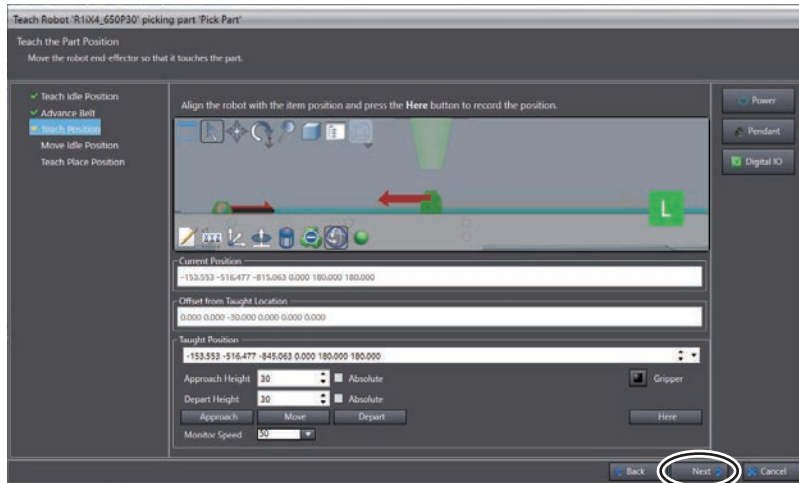

● **Moving the Robot to the Idle Position**

1 Click the **Move** button at the lower part of the dialog box.

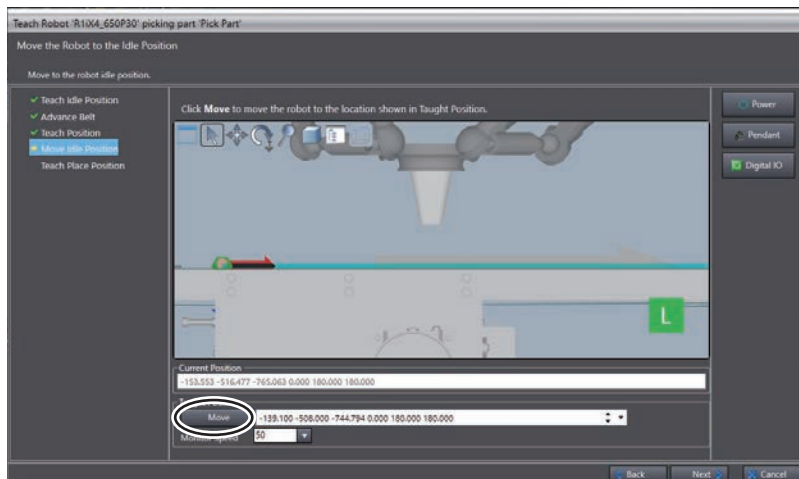

When the robot moves to the idle position, click the **Next** button at the bottom right of the dialog box.

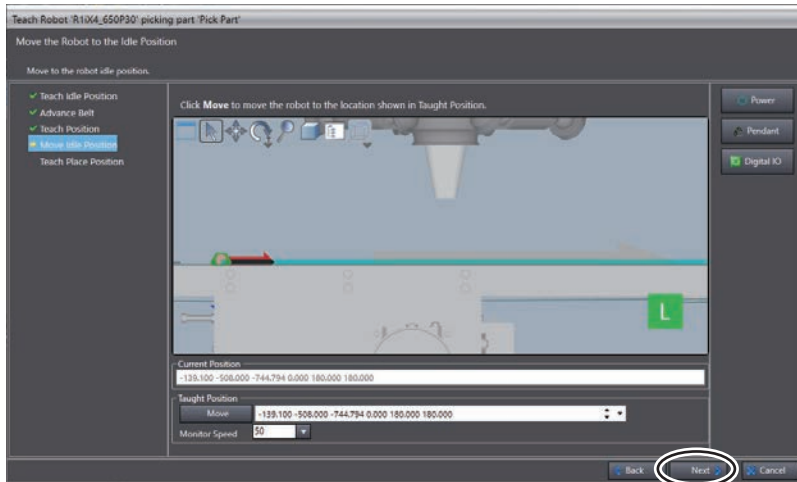

### ● Teaching Place Position, Approach Height, and Depart Height

- 1 Operate the robot in the **3D Visualizer** and move it to the workpiece place position on the conveyor.

If the tool center point and the conveyor come into contact, the outlines of the tool center point and conveyor are highlighted. Determine the place position with reference to the highlighting.

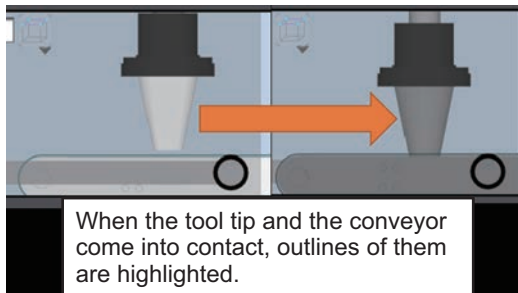

- 2 Click the **Here** button at the bottom right of the dialog box.

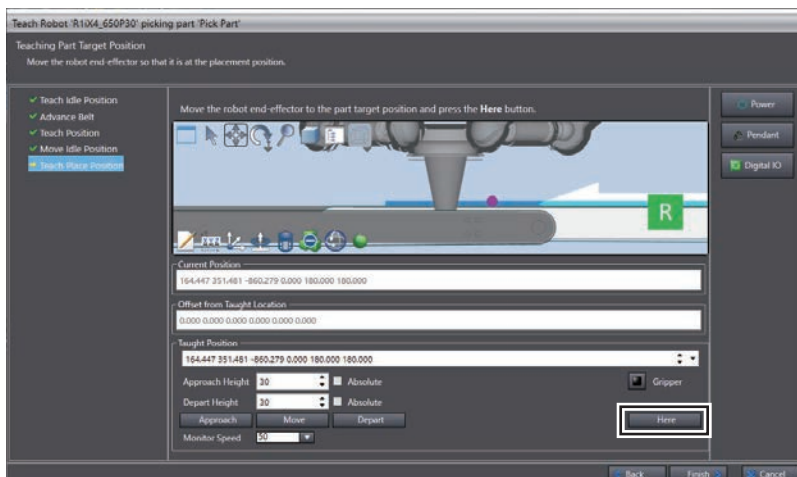

The values of the current position is set to the **Taught Position** box. If you want to fine tune the taught position, modify the value in the **Taught Position** and click the **Move** button to move the robot.

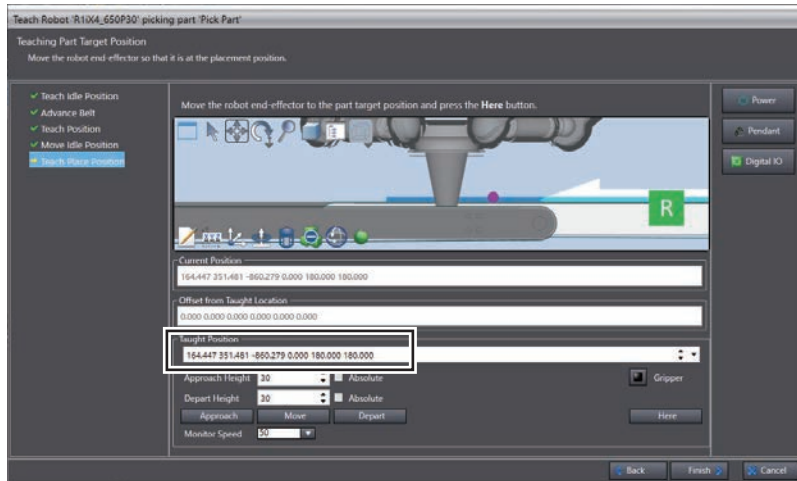

- 3** Enter the elevation distance of the workpiece place approach point in the **Approach Height** and **Depart Height** input fields of **Taught Position**.

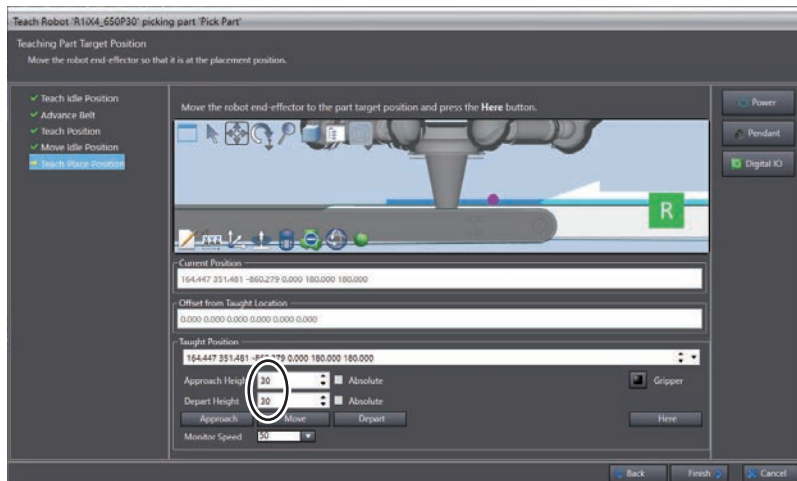

Check the operation by moving the robot to the set heights by pressing the **Approach** and **Depart** buttons.

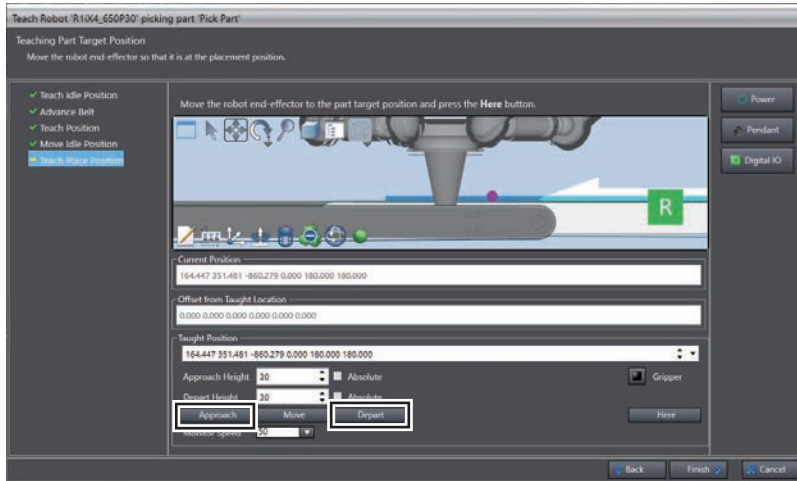

- 4 Click the **Finish** button at the bottom right of the dialog box.

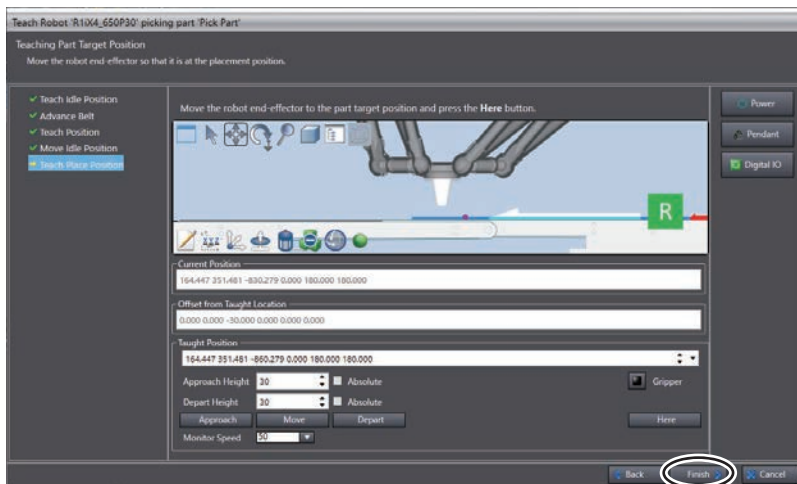

Teaching dialog box closes and **ApplicationManager1** is added to the drop-down list of the Multiview Explorer.

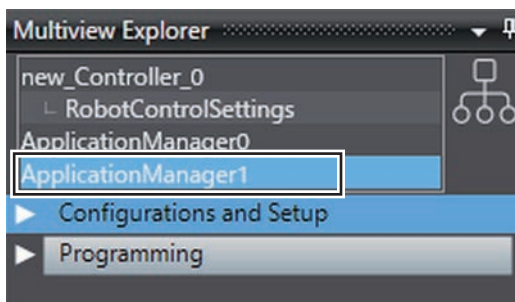

## Additional Settings

### ● Setting for Active Control

To activate the conveyor control from the Pack Manager, perform the following.



- 1 In the Multiview Explorer, select **ApplicationManager1** from the device list.

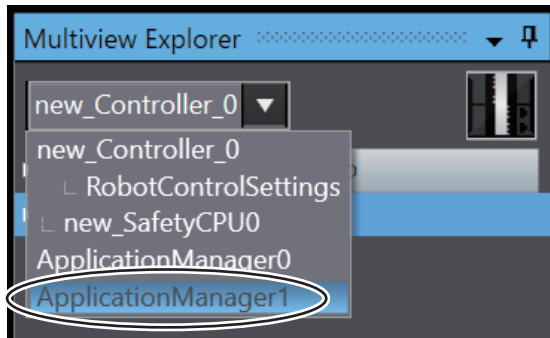

- 2 Select **Configurations and Setup - Processes** in the Multiview Explorer and double-click **Pick Belt**.

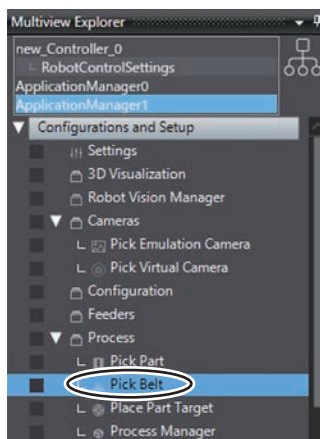

- 3 Select the **Active Control** check box for **Belt Control**.



## 4-3-7 Creating C# Programs

This section describes the procedure to create C# programs. For details on the program to create, refer to *C# Programs* on page 4-10.

- 1 In the Multiview Explorer, select **ApplicationManager1** from the device list.

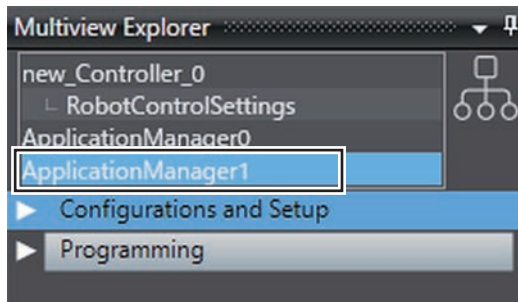

- 2 Right-click **Programs** under **Programming** in the Multiview Explorer. The menu commands are displayed.
- 3 From the menu, select **Add - C# Program**.

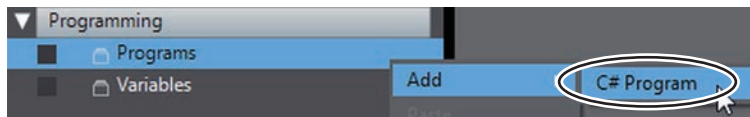

A new program **C# Program0** is added under **Programs**.

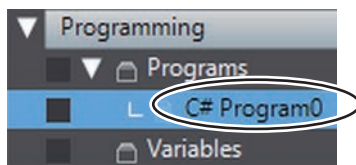

- 4 Right-click the **C# Program0** and select **Rename** from the menu.

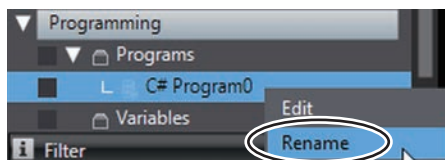

This allows you to edit the name of the **C# Program0**.

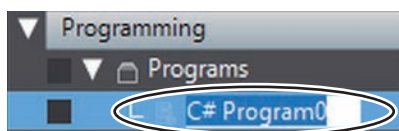

- 5 Enter *PM\_Start* for the program name and press the Enter key. The name of the C# program is changed to "PM\_Start".

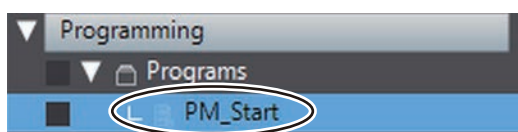

- 6 Double-click the program that was added.

A tab page to edit the program is displayed in the Edit Pane.

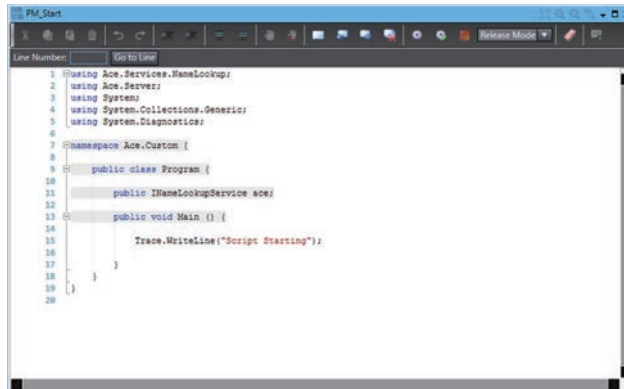

- 7 Repeat the operations from step 3 to step 6 to create the programs PM\_Start and PM\_Stop described in *C# Programs* on page 4-10.



### Precautions for Correct Use

The contents of the text string that represents the Process Manager in each C# program differ depending on the language of OS used when you created the project file. Select **ApplicationManager1** from the device list in the Multiview Explorer, and then select **Configurations and Setup - Process - Process Manager**. Drag and drop it onto the C# editor, and an appropriate text string is automatically entered.

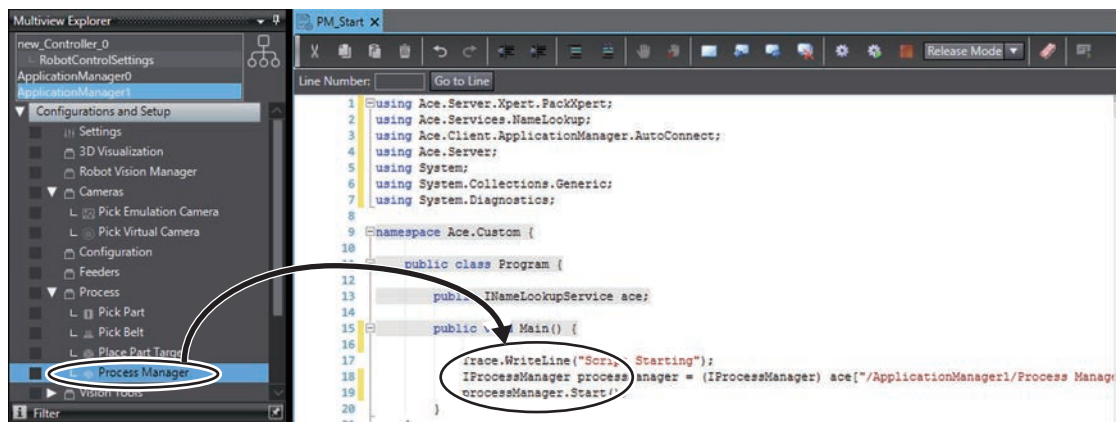

## 4-3-8 Setting up Automatic Loading of V+ Programs and Variables at Power ON

The V+ programs that you created and V+ global variables are not automatically loaded to the Robot Integrated CPU Unit by default settings of the project when power to the Robot Integrated CPU Unit is turned ON.

This section describes the setting procedure for automatically loading the V+ programs and V+ global variables to the Robot Integrated CPU Unit when its power is turned ON.

- 1 Select **RobotControlSettings** from the device list in the Multiview Explorer.

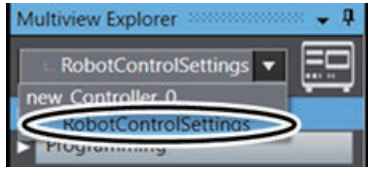

2 Click **Configurations and Setup** in the Multiview Explorer.

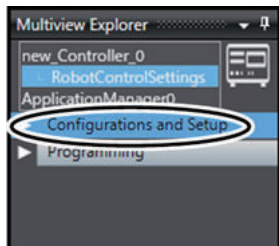

Setting items are displayed under **Configurations and Setup** in the tree.

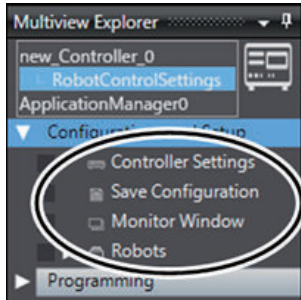

3 Double-click **Save Configuration**.

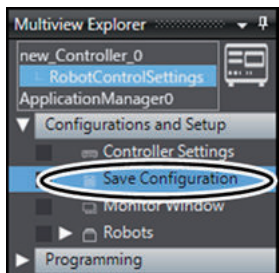

The **Save Configuration** tab page is displayed in the Edit Pane.

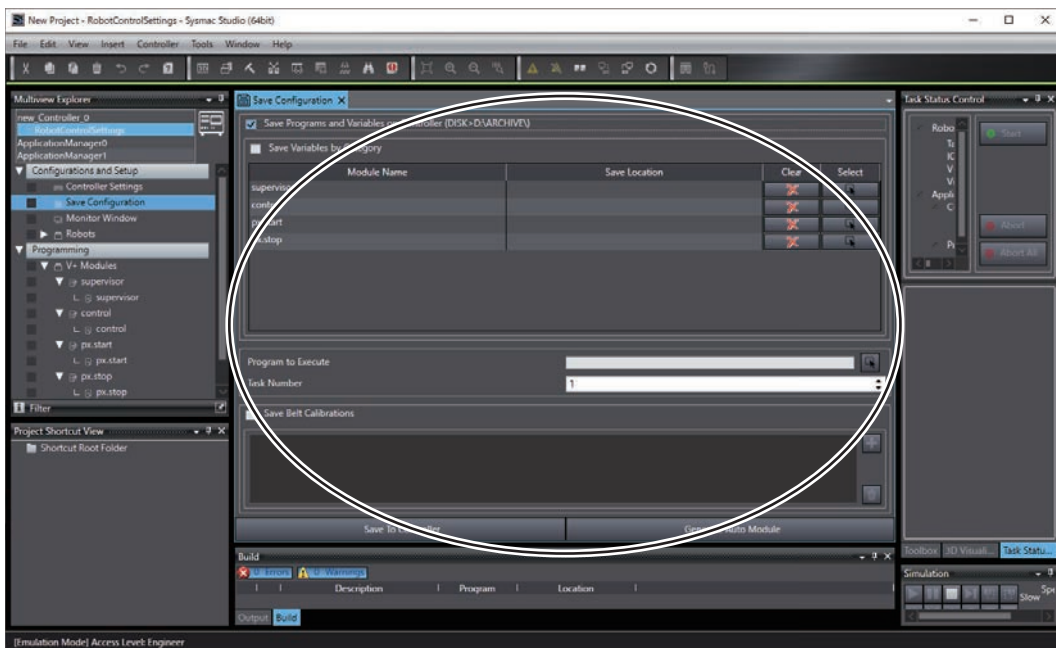

- 4 Make sure that *supervisor* is not selected for **Program to Execute** and click the button on the right.

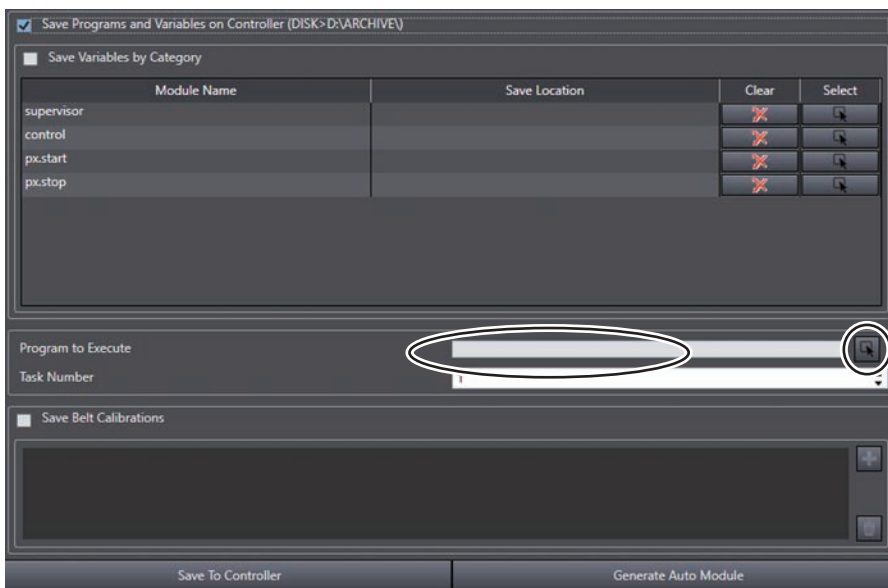

The **Select the startup program** dialog box appears.

- 5 Select **supervisor** under **supervisor** and click the **Select** button.

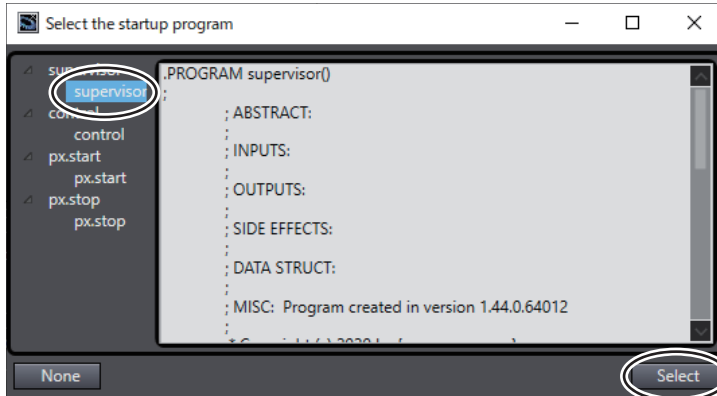

6 Enter 2 to Task Number.

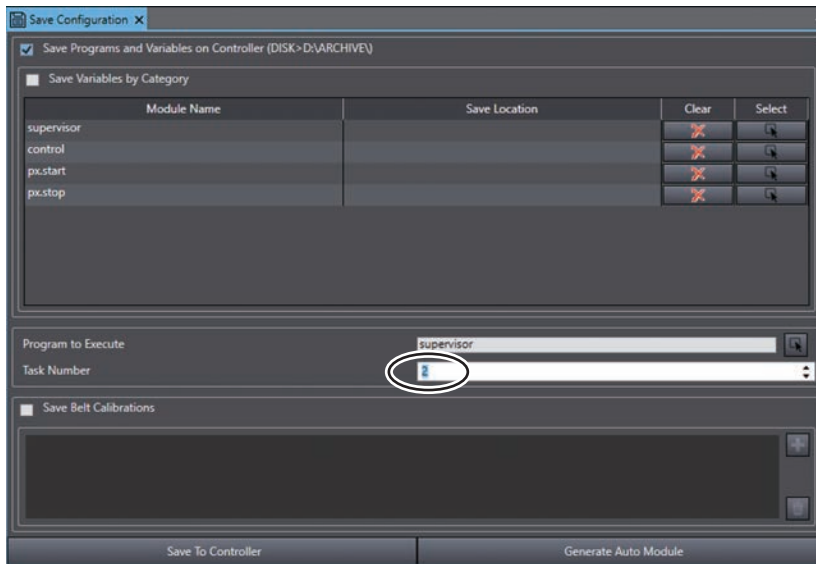

7 Click the **Generate Auto Module** button in the **Save Configuration** tab page.

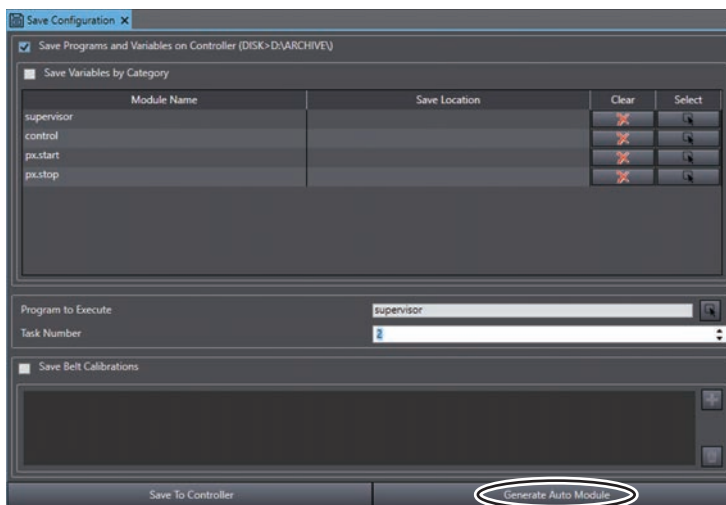

The module name **auto** is added to the module list in the **Save Configuration** tab page. In the tree of the Multiview Explorer, **V+ Modules - auto** are added under **Programming**.

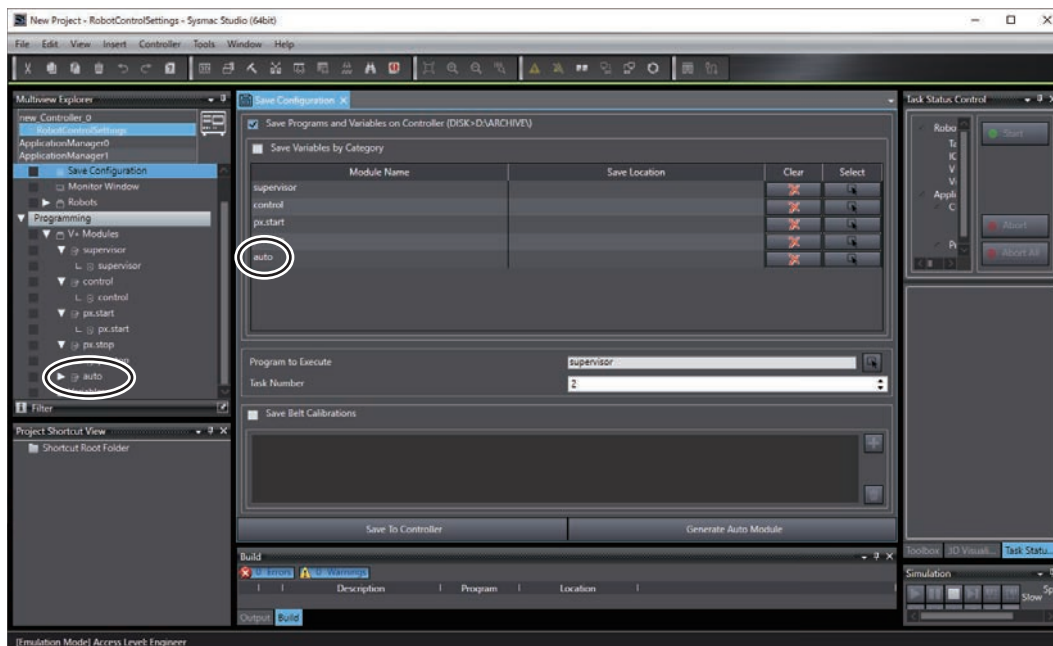

- 8 Click **File - Save** from the menu bar.

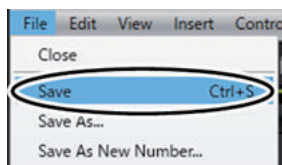

The Robot Integrated CPU Unit is now configured to automatically load the V+ programs and V+ global variables when it is powered ON. The program **auto** starts automatically when the Robot Integrated CPU Unit is powered ON and reads the saved V+ programs and V+ global variables.

The program **auto** is created in a form called command program, which is different from the V+ program. For details about the command program, refer to the *eV+3 User's Manual (Cat. No. 1651)*.

### 4-3-9 Executing Program to Check Operation

This section describes the procedure to run and simulate the sequence control program created in *4-3-4 Writing a Sequence Control Program* on page 4-23.

You can run the program by changing the global variable *gStart* in the sequence control program from FALSE to TRUE in the Watch Tab Page.

The V+ program is called from the sequence control program executed in this procedure.



#### Precautions for Correct Use

When you perform this procedure, check that the project file has been opened in EMULATION mode. Refer to *Enabling Robot Simulation Function* on page 3-65 for the checking procedure.



**Additional Information**

Refer to the *Sysmac Studio Version 1 Operation Manual (Cat. No. W504)* and *Sysmac Studio Robot Integrated System Building Function with Robot Integrated CPU Unit Operation Manual (Cat. No. W595)* for details on the debugging function of the program.

- 1 Select **RobotControlSettings** from the device list in the Multiview Explorer.

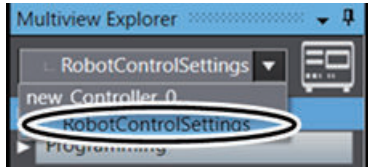

- 2 Select **Task Status Control** from the **View** menu on the main window.

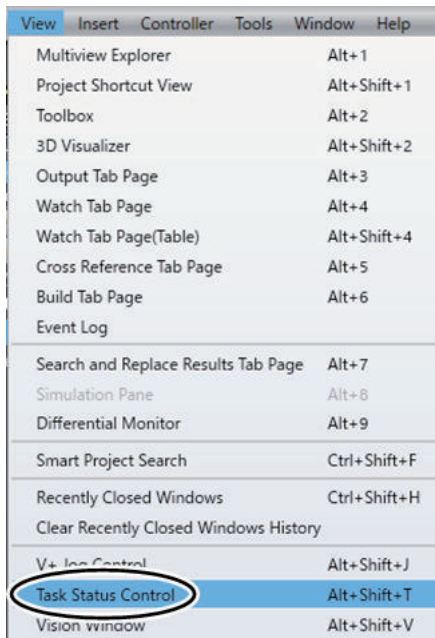

The **Task Status Control** pane appears on the right side of the main window.

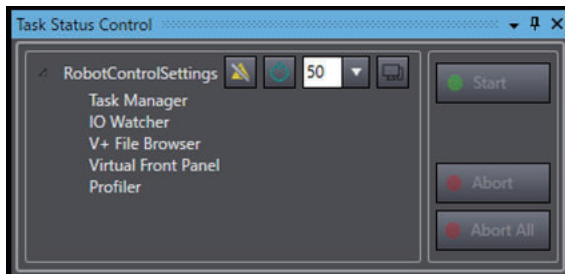

- 3 On the Multiview Explorer, select **Programming - V+ Modules - supervisor - supervisor** and right-click on it, and then select **Execute on Task – Task 2**.



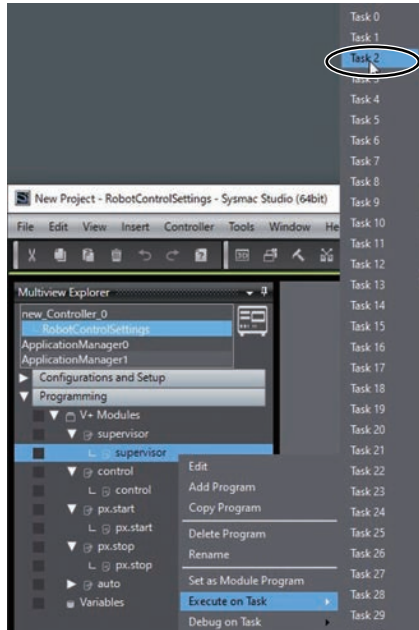

The V+ program supervisor starts to run in Task 2 and the control launches in Task 3.

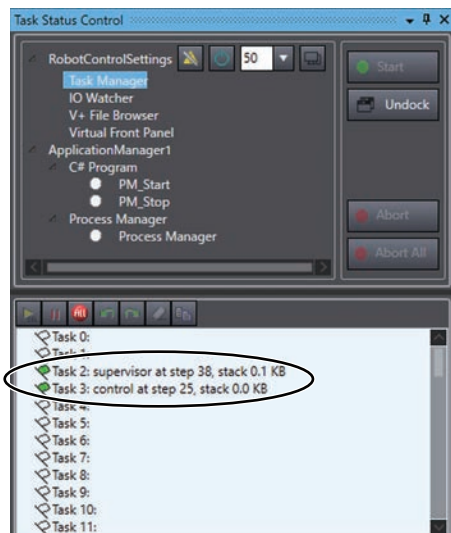

- 4 In the Multiview Explorer, select **new\_Controller\_0** from the device list.

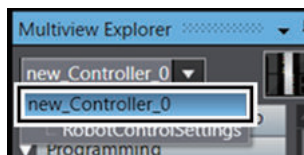

- 5 Select **3D Visualizer** from the **View** menu on the main window of the Sysmac Studio.

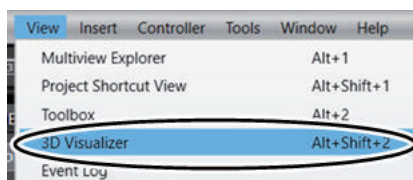

The 3D Visualizer is displayed on the right side of the main window.

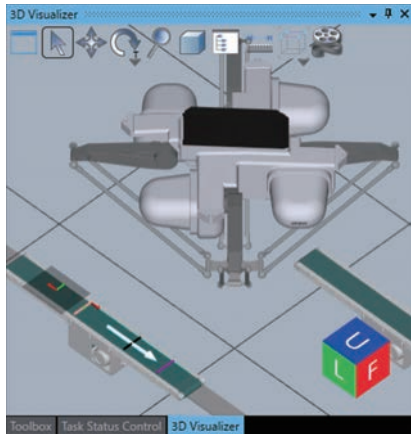

**6** Select **Watch Tab Page** from the **View** menu on the main window.

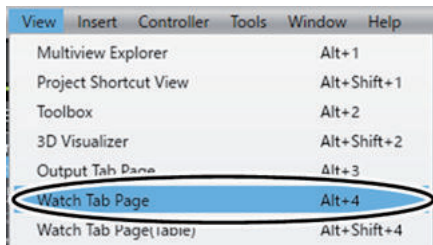

The **Watch (Project)1** tab page appears at the bottom of the main window.

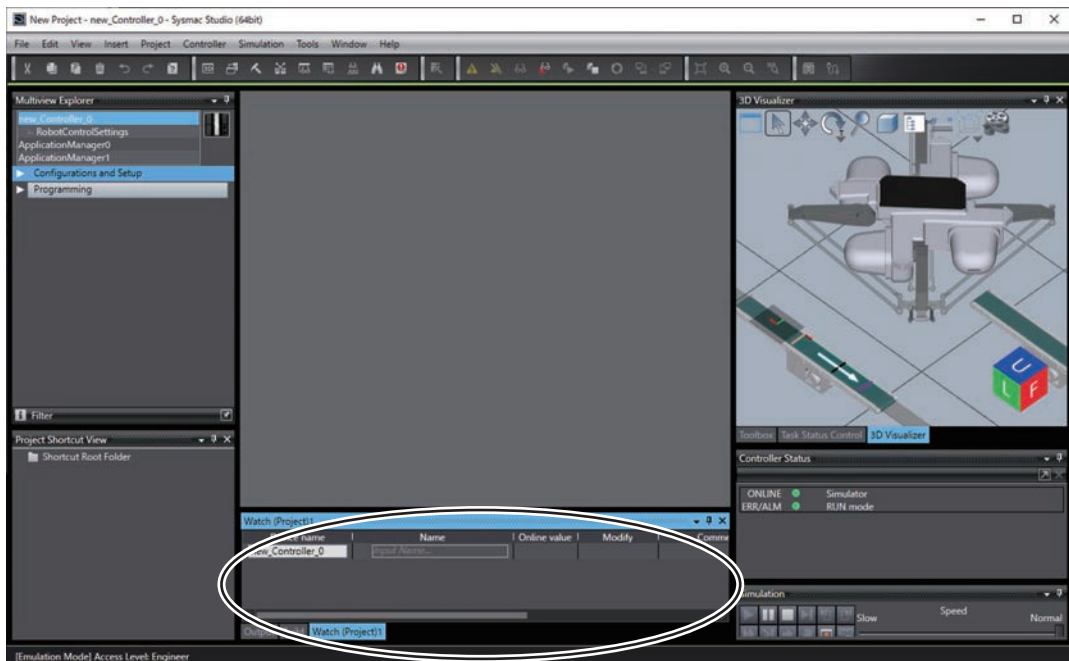

**7** Type **gStart** in the **Name** column on the *Watch (Project)1* tab page. The **Online value** column shows the current value **False** for the internal variable **gStart** in **Program0**.

Watch (Project)1						
Device name	Name	Online value	Modify		Comment	D
new_Controller_0	lgStart	False	TRUE	FALSE	Auto start Button	BC
new_Controller_0	Input Name...					

- 8 Click the **TRUE** button in the **Modify** column for the variable **gStart** in the **Watch (Project)1** tab page.

Watch (Project)1						
Device name	Name	Online value	Modify		Comment	D
new_Controller_0	lgStart	False	TRUE	FALSE	Auto start Button	BC
new_Controller_0	Input Name...					

The robot starts operating and picks the part in the 3D Visualizer.

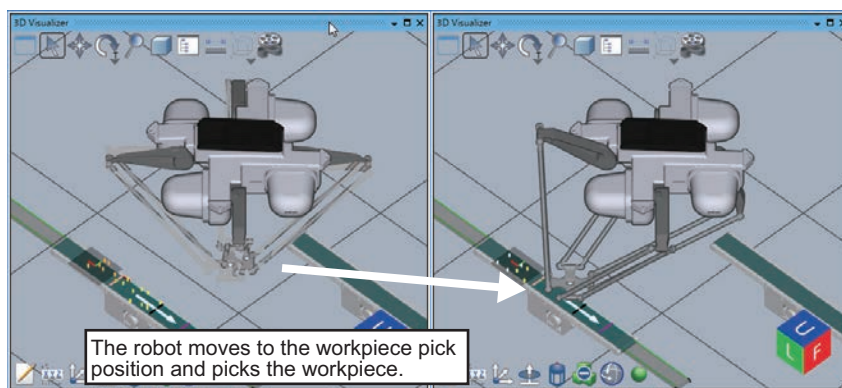

After that, the robot moves to the robot wait position via the workpiece place position, and performs pick and place operation repeatedly.

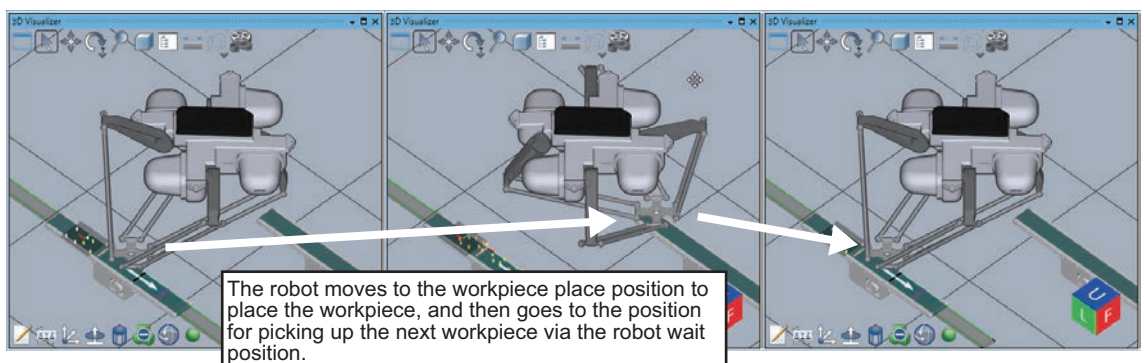

During operation, check that the robot does not turn gray in locations other than the workpiece pick-up position and workpiece place position. If the color changes to gray, the robot and the conveyor are interfering with each other. In that case, refer to *Teaching Pick Position, Approach Height, and Depart Height* on page 4-74 and move the workpiece pick-up approach point or the workpiece place approach point to a higher position by teaching.

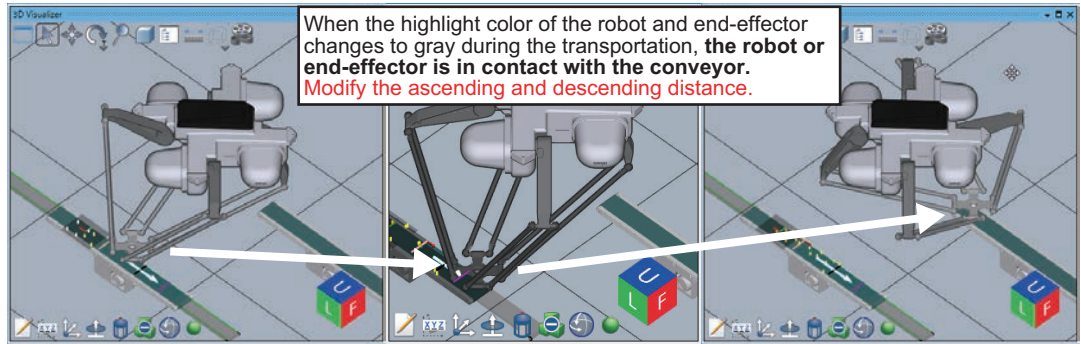

Now you can run the sequence control program on the actual equipment.

## 4-4 Installing and Wiring the System

In the system configuration, you must wire the signal lines covered in the colored areas in the figure below and set the node address of the robot.

- Wiring between the Robot Integrated CPU Unit (A), EtherCAT Digital I/O Terminal (O), EtherCAT communications unit of the Inverter (T), and robot (X)
- Wiring between the Robot Integrated CPU Unit (A), industrial Ethernet switch (D), computer (F), and IPC Application Controller (H).
- Wiring between the robot (X), T20 pendant (Y), front panel (AA), and encoder (AD)
- Wiring between the IPC Application Controller (H), display (J), and camera (L).
- Wiring between the EtherCAT Digital I/O Terminal (O) and robot (C)
- Wiring between the camera (L) and robot (X)
- Wiring between the EtherCAT Digital I/O Terminal (O) and solenoid valve (P)

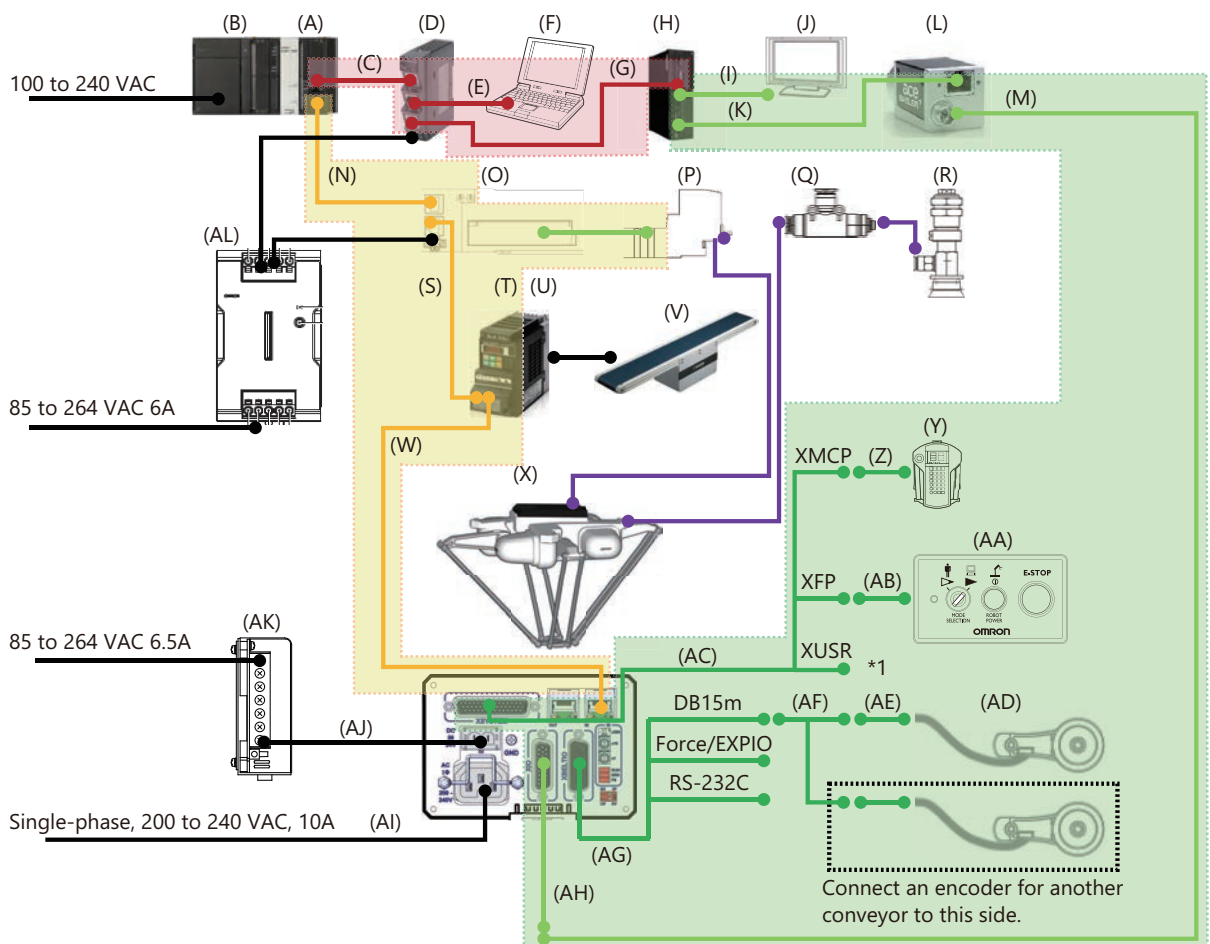

Refer to *1-5 System Configuration for Dynamic Pick-and-place Equipment* on page 1-8 for information on the parts used in the system configuration.

Refer to the manual for the specific product for details on power lines not covered in the colored area as well as for ducting from the robot.

### 4-4-1 Wiring the Robot Integrated CPU Unit and the EtherCAT Digital I/O Terminal

You must wire the Robot Integrated CPU Unit and the EtherCAT Digital I/O Terminal.

- 1 Connect the EtherCAT port of the Robot Integrated CPU Unit and the EtherCAT IN port of the EtherCAT Digital I/O Terminal with an Ethernet cable.

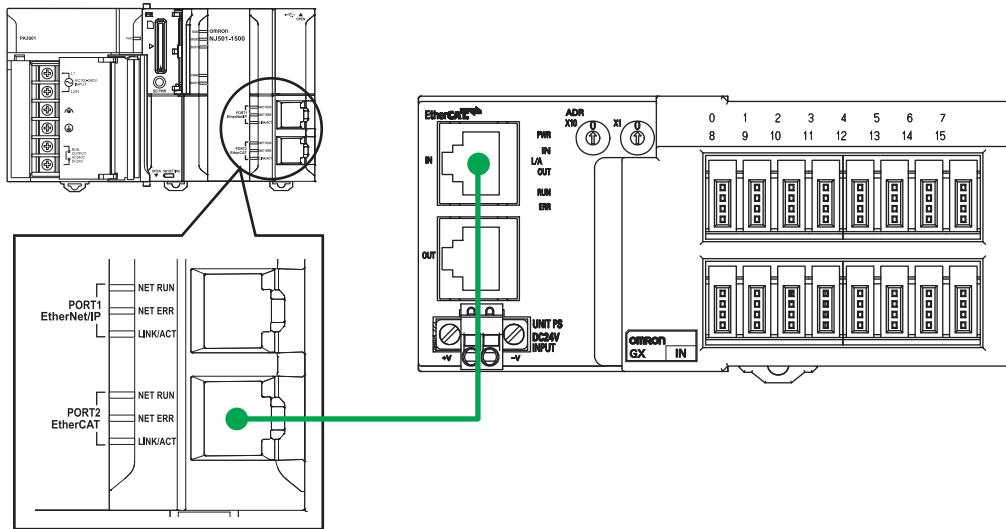

### 4-4-2 Setting the Node Address of the EtherCAT Digital I/O Terminal

You must set the EtherCAT node address of the EtherCAT Digital I/O Terminal.

- 1 Use the switches on the EtherCAT Digital I/O Terminal to set the EtherCAT node address. To set the node address to 1, set the x10 switch to 0 and the x1 switch to 1.

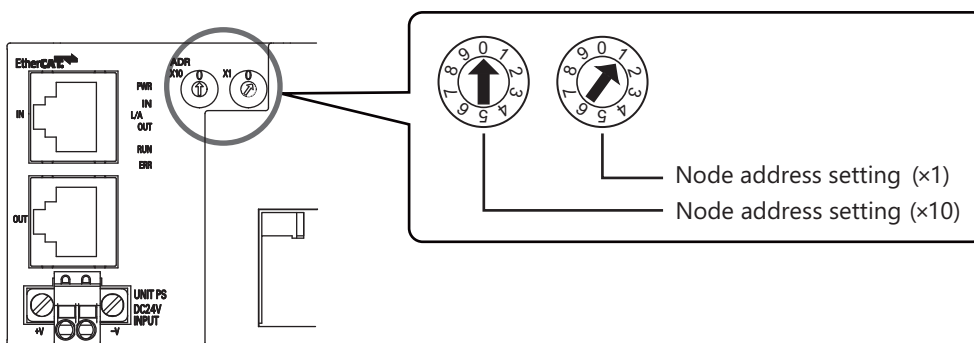

#### Precautions for Correct Use

Set the EtherCAT node address of the EtherCAT Digital I/O Terminal to be the same as the node address set in 3-3-2 *Creating the EtherCAT Network Configuration* on page 3-20.

### 4-4-3 Wiring the EtherCAT Digital I/O Terminal and Inverter's EtherCAT Communications Unit

Wire the EtherCAT Digital I/O Terminal and EtherCAT Communications Unit of the Inverter.

- 1 Connect the EtherCAT OUT port of the EtherCAT Digital I/O Terminal and the EtherCAT IN port on the EtherCAT Communications Unit with an Ethernet cable.

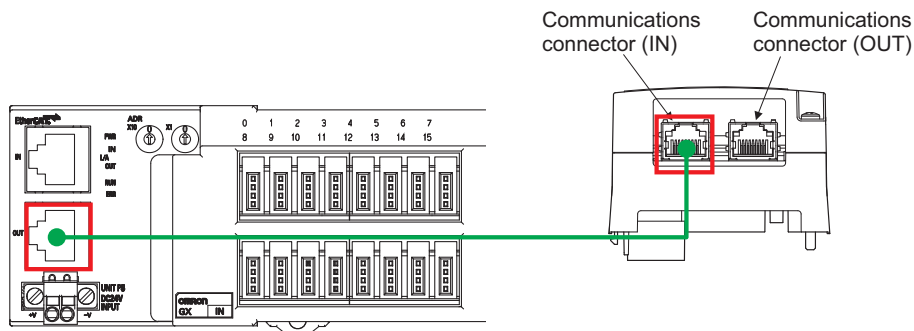

### 4-4-4 Setting the Node Address of Inverter's EtherCAT Communications Unit

This section describe the settings of the EtherCAT node address of the EtherCAT Communications Unit of the inverter.

- 1 Set the switches for the EtherCAT node address on the EtherCAT Communications Unit of the inverter.  
To set the node address to 2, set the x10 switch to 0 and the x1 switch to 2.

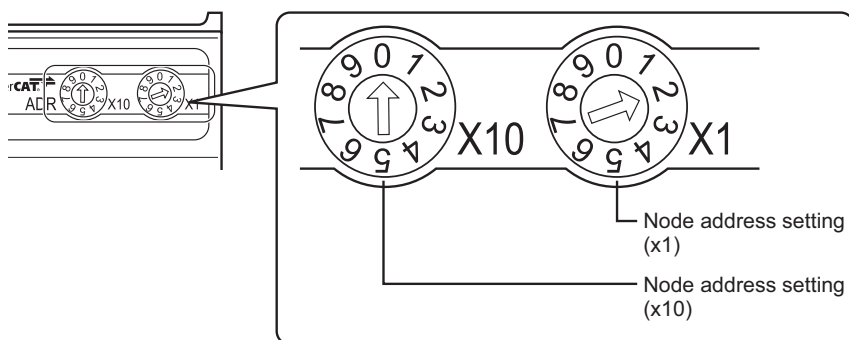

#### Precautions for Correct Use

Set the EtherCAT node address of the inverter to be the same as the node address set in 3-3-2 *Creating the EtherCAT Network Configuration* on page 3-20.

### 4-4-5 Wiring the Inverter's EtherCAT Communications Unit and Robot

In this section, wire the EtherCAT communications unit of the inverter and the robot.

- 1 Connect the EtherCAT OUT port of the EtherCAT Communications Unit and the EtherCAT IN port on the interface panel of the robot with an Ethernet cable.

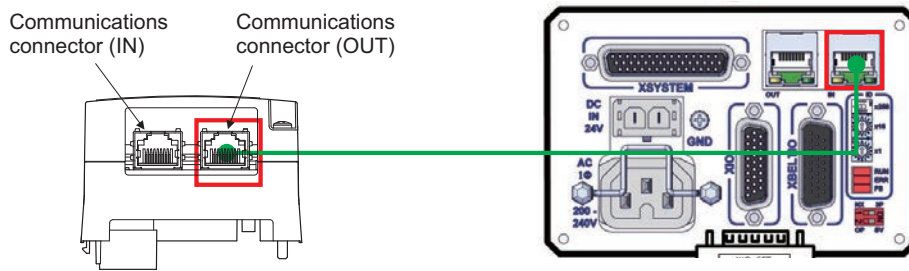

### Precautions for Correct Use

Refer to the *NJ/NX-series CPU Unit Built-in EtherCAT Port User's Manual (Cat. No. W505)* for details on the Ethernet cable to be used.

## 4-4-6 Setting the EtherCAT Node Address of the Robot

Set the EtherCAT node address of the robot.

- 1 Set the EtherCAT node address with the switches on the interface panel of the robot. To set the node address to 3, set the x256 switch to OFF, the x16 switch to 0, and the x1 switch to 3.

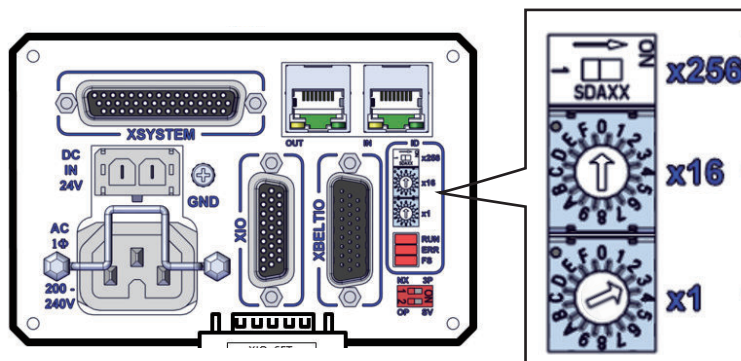

### Precautions for Correct Use

Set the EtherCAT node address of the robot to be the same as the node address set in *4-3-2 Creating the EtherCAT Network Configuration* on page 4-16.

Refer to the manual for your robot on how to set the node address.

## 4-4-7 Wiring the Robot, T20 Pendant and the Front Panel

You must wire the robot and the T20 pendant, as well as the robot and the front panel. Use an XSYSTEM cable assembly, a T20 adapter cable, and a front panel cable for wiring.

- 1 Connect the robot and the XSYSTEM cable assembly.



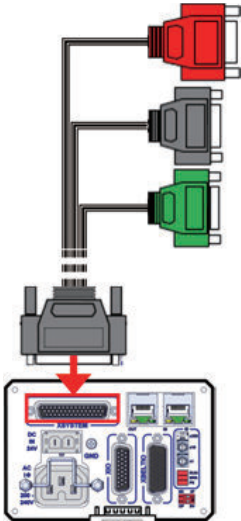

**2** Connect the XMCP connector (Red) of the XSYSTEM cable assembly and the T20 adapter cable.

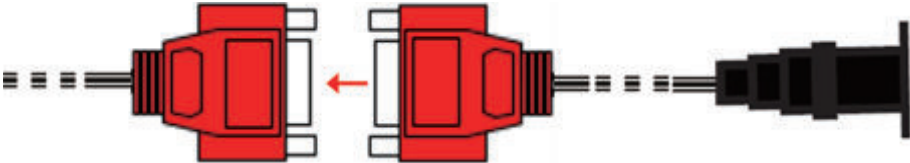

**3** Connect the T20 adapter cable to the T20 pendant.



**4** Connect the XFP connector (Green) of the XSYSTEM cable assembly and the front panel cable.

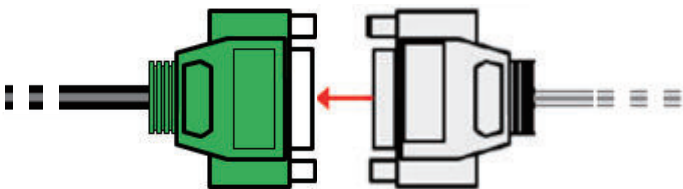

**5** Connect the front panel cable and the front panel.

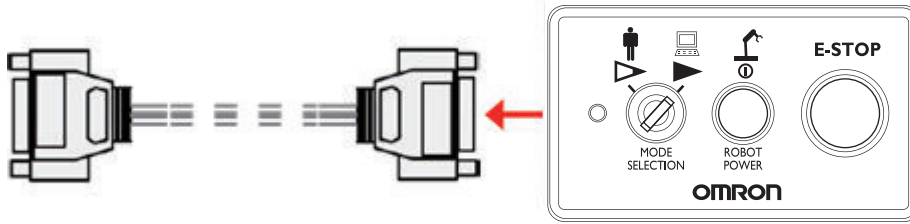

### 4-4-8 Wiring the Robot and Encoder

Wire the robot and the encoder. Use a XBELTIO cable, a Y-adapter cable, and an encoder extension cable for wiring.

- 1 Connect the XBELTIO cable to the robot.

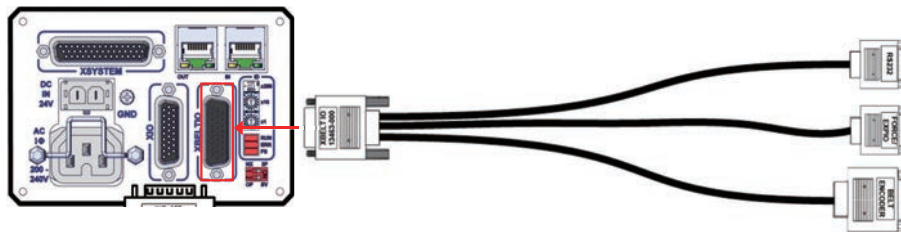

- 2 Connect the XBELTIO cable's DB connector and the Y-adapter cable.

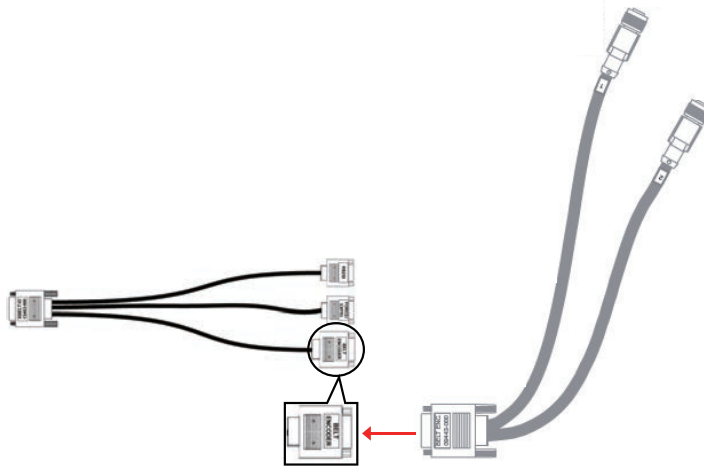

- 3 Connect the encoder extension cable to the connector labeled [1] of the Y-adapter cable.

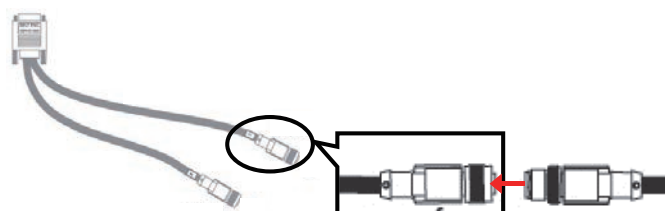

- 4 Connect the encoder and the encoder extension cable.



### 4-4-9 Wiring the EtherNet/IP Port on the Robot Integrated CPU Unit

Wire between the Robot Integrated CPU Unit and the industrial Ethernet switch, between the industrial Ethernet switch and the computer, and between the industrial Ethernet switch and the IPC Application Controller. Use Ethernet cables for connection.

- 1 First, wire the Robot Integrated CPU Unit and the industrial Ethernet switch.

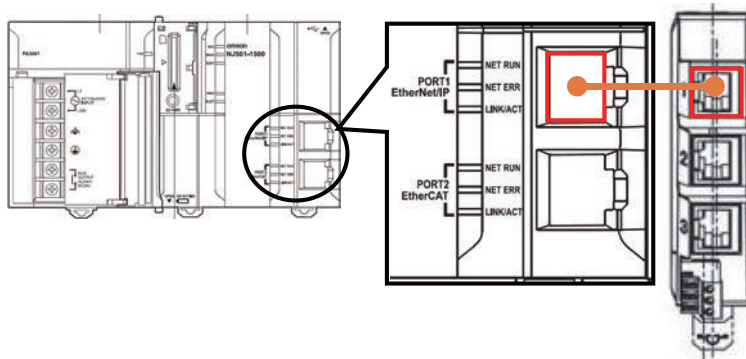

- 2 Connect the industrial Ethernet switch and the computer.

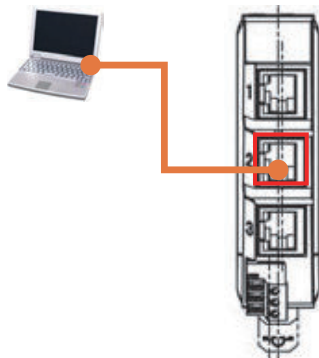

- 3 Connect the industrial Ethernet switch and the IPC Application Controller.

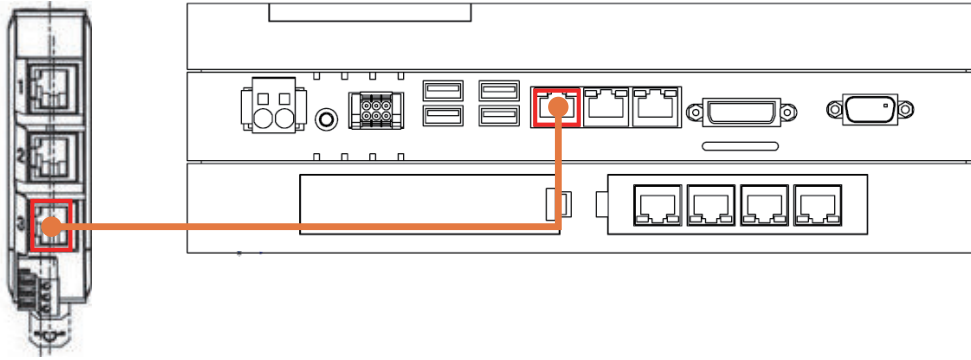

#### 4-4-10 Wiring Between the IPC Application Controller, Display, and Camera

Wire between the IPC Application Controller and the display, and between the IPC Application Controller and the camera. Use a DVI cable and a camera cable for wiring.

- 1 Connect the DVI ports on the IPC Application Controller and the display with a DVI cable.



##### Precautions for Correct Use

Refer to the *IPC Application Controller User's Manual (Cat. No. I632)* for information on the DVI cable.

- 2 Connect the PoE ports on the IPC Application Controller and the camera with a camera cable.

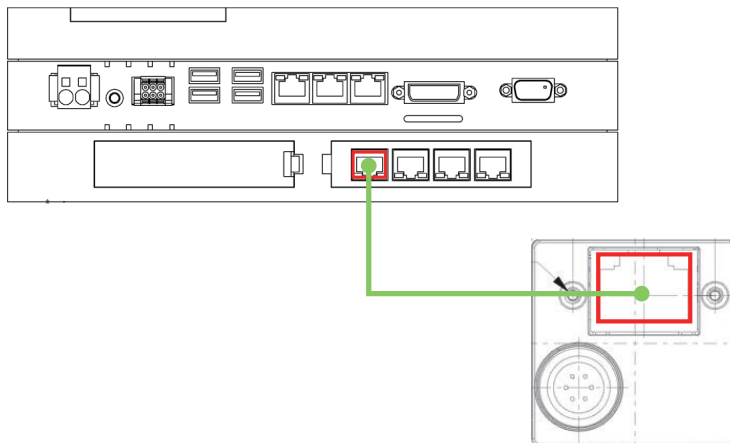

#### 4-4-11 Wiring the Camera and Robot

Wire the camera and the robot. Use a power I/O cable and a XIO breakout cable for wiring.

- 1 Connect the camera and the power I/O cable.

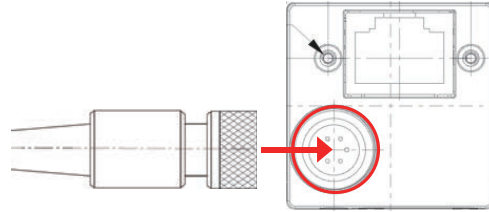

- 2 Wire the power I/O cable and the XIO breakout cable. Make a connector or relay with a terminal block as shown in the following wiring diagram.

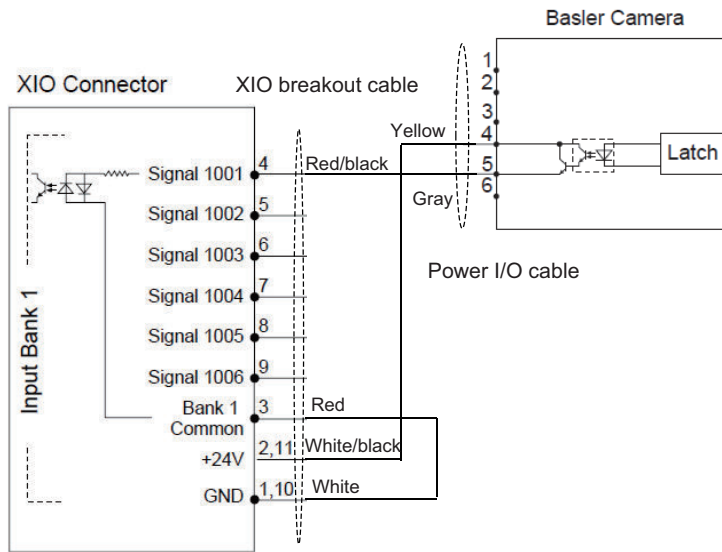

- 3 Connect the XIO breakout cable and the robot.

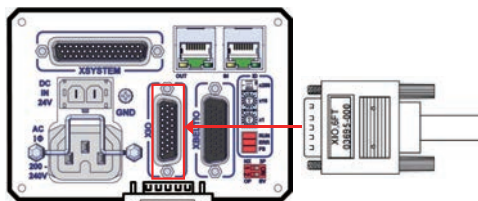

**Precautions for Correct Use**

Refer to *Configuring the Camera, Conveyor, and Encoder* on page 4-65 for the installation location of the camera. You must install the camera between the upstream limit set by the software and the entrance of the conveyor.

**4-4-12 Wiring the EtherCAT Digital I/O Terminal and Solenoid Valve**

You must wire the EtherCAT Digital I/O Terminal and the solenoid valve. Refer to the manuals for the EtherCAT Digital I/O Terminal and the solenoid valve for details on the cable wiring, and make the cable appropriately in accordance with the wiring diagrams and specifications.

- 1 Make the cable so that the solenoid valve will behave as shown in the table below.

Output value of Digital I/O Terminal	Solenoid valve behavior
FALSE	Duct is closed
TRUE	Duct is open

**2** Wire the EtherCAT Digital I/O Terminal and the solenoid valve.

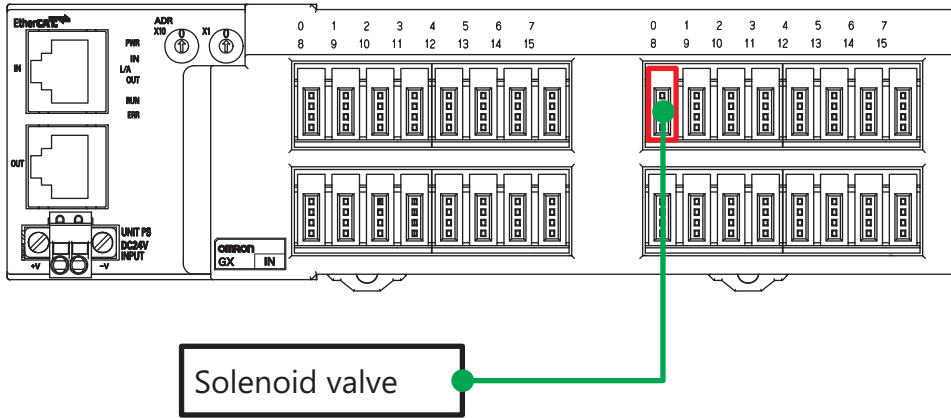

## 4-5 Operation Check on the Actual System

This section describes the procedures for checking operation and adjusting the system on the actual system.

Check operation with the simulation function before you check operation on the actual system.



### Precautions for Correct Use

When you operate the robot in MANUAL mode with the T20 pendant, you must plug the iCS Commissioning Jumper into the XBELTIO connector and change the setting for the Teach Restrict. Refer to *iX4 650 H/H/S and 800 H/H/S Robot with EtherCAT User's Guide (Cat. No. I656)* for details.

### 4-5-1 Communications Setup

#### Setting Up Sysmac Studio to Communicate with the Robot Integrated CPU Unit

Set up Sysmac Studio installed on your PC to communicate with the Robot Integrated CPU Unit.

In this section, IP address of the EtherNet/IP port on the Robot Integrated CPU Unit to connect to the computer is set to 192.168.250.1.

Also set the IP address of the camera to the IPC Application Controller in advance. For procedure to set the IP address of the camera to the IPC Application Controller, refer to Appendix A of the *Automation Control Environment (ACE) Version 4 User's Manual (Cat. No. I633)*.

- 1 Boot up the Sysmac Studio.
- 2 Clear the **Open in Emulation Mode** check box at the bottom left of the start page.



- 3 Click the **Open Project** tab.



A list of created projects is shown in the **Projects** window.

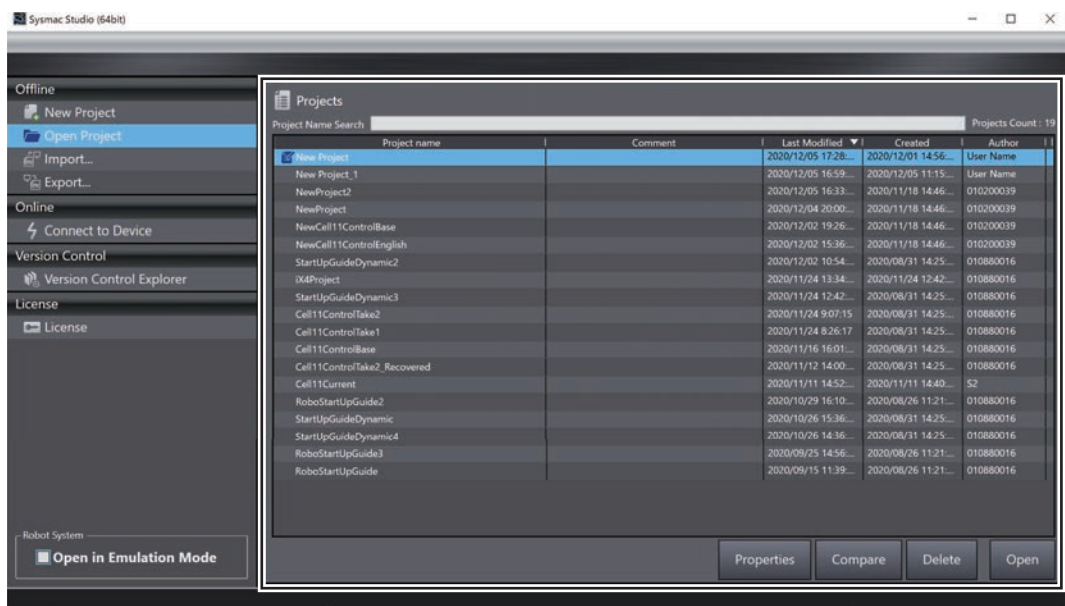

- 4 Click the **New Project** on the project list, which you have created in 4-3-1 *Creating a Project File* on page 4-15.



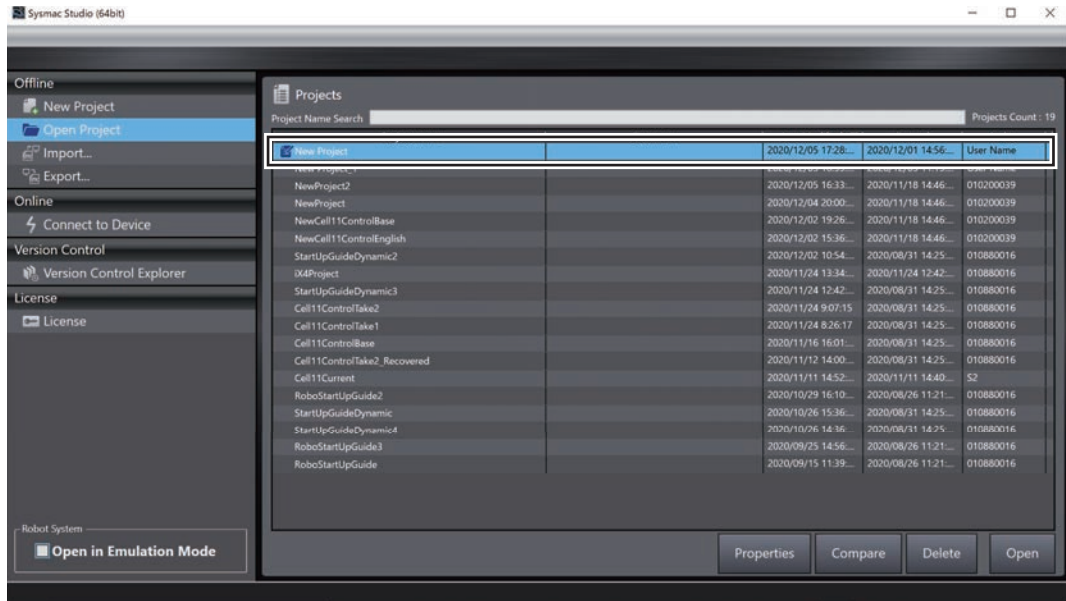

The clicked row is highlighted.

## 5 Click the **Open** button in the **Projects** window.

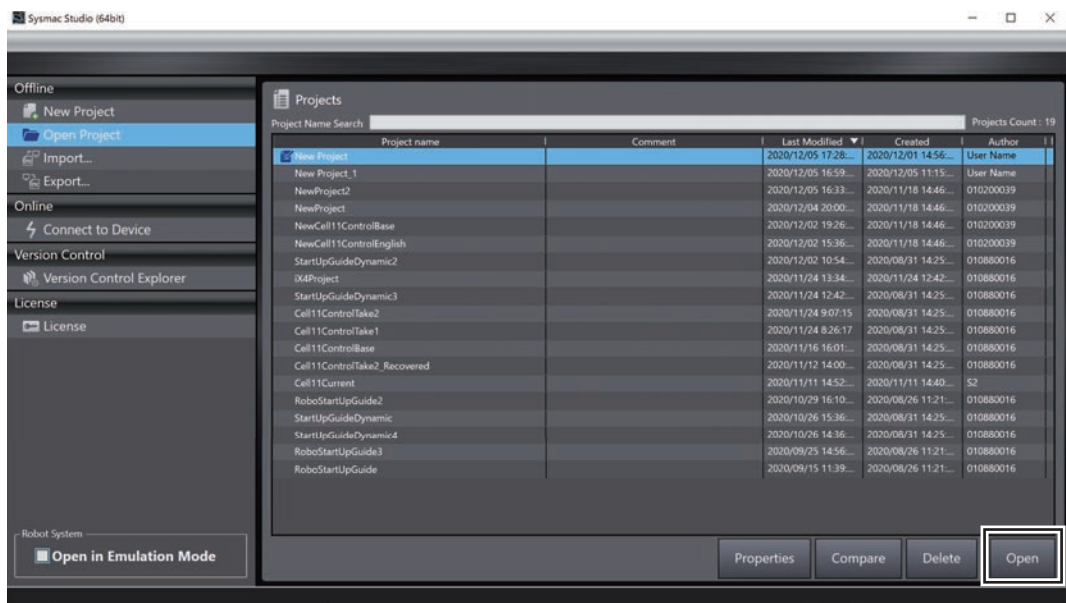

The main window of Sysmac Studio is displayed.

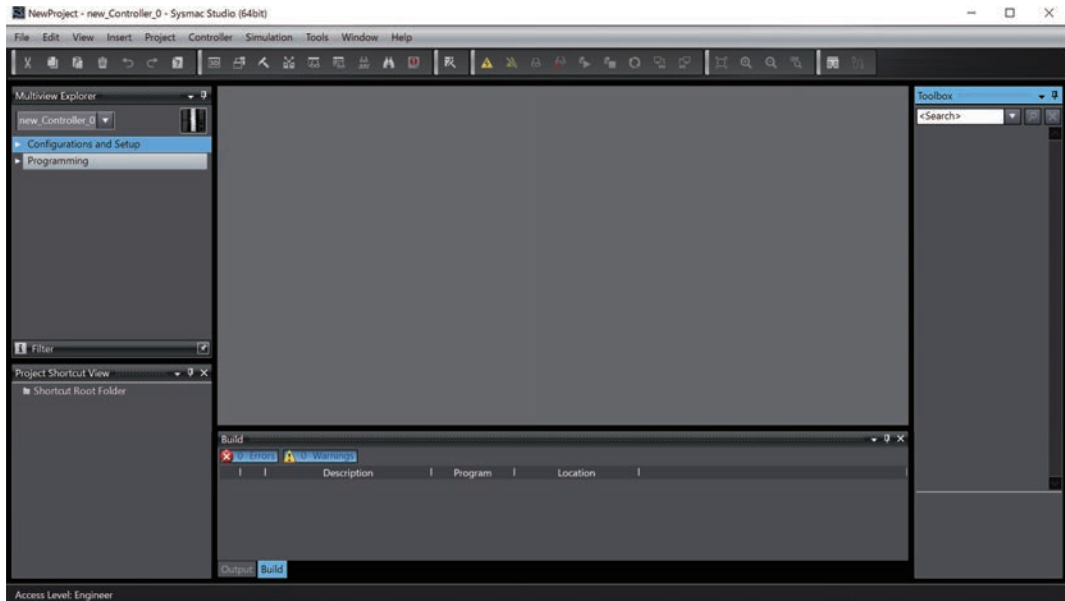

- 6** Select **Controller - Communications Setup** from the menu bar in the main window.

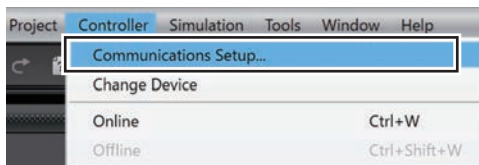

The **Communications Setup** dialog appears.

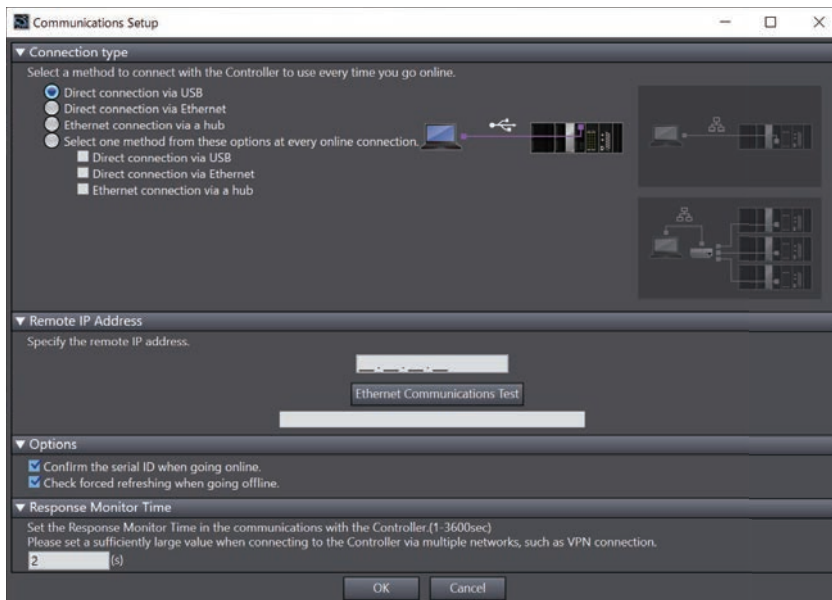

- 7** Click the **Ethernet connection via a hub** button in the Connection type field.

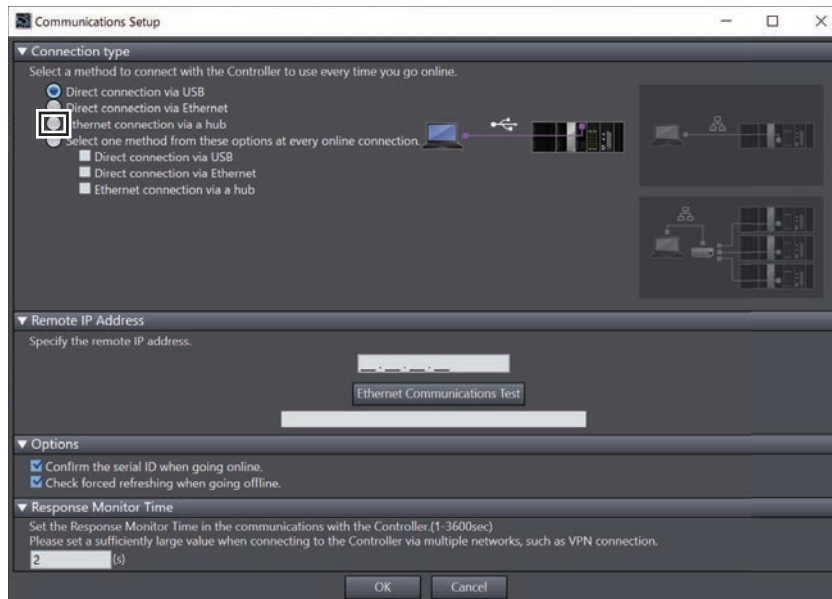

- 8 Enter *192.168.250.1*, the IP address of the Robot Integrated CPU Unit, in the **Remote IP Address** box

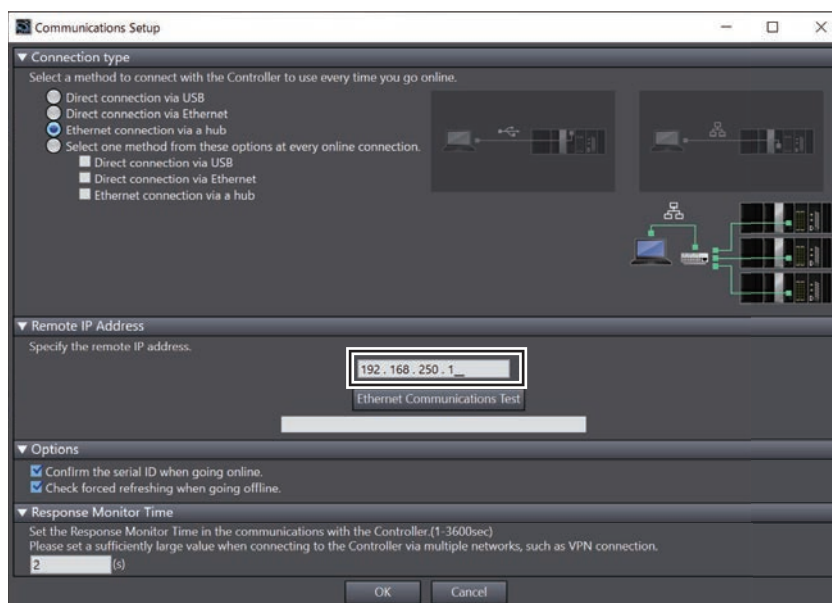

- 9 Click the **OK** button at the bottom

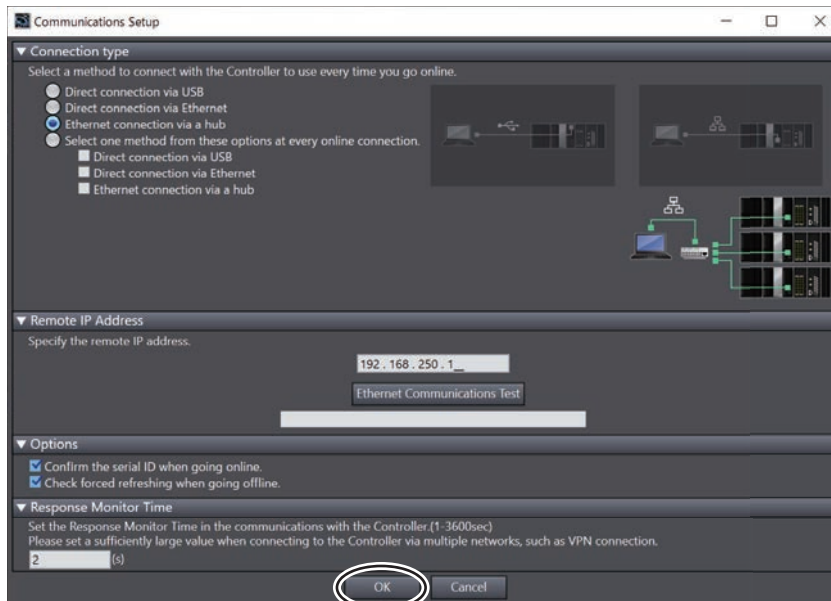

The **Communications Setup** dialog is closed.

## Selecting the IPC Application Controller

Select the IP address of the IPC Application Controller you use.

In this section, the IP address for the IPC Application Controller is 192.168.250.201. Set the IP address of the IPC Application Controller before starting the following procedure.



### Precautions for Correct Use

ACE must have been running as a server in the IPC Application Controller in advance. Refer to *Automation Control Environment (ACE) Version 4 User's Manual (Cat. No. I633)* for the ACE server instance.

- 1 Select **ApplicationManager1** from the device list in Multiview Explorer.

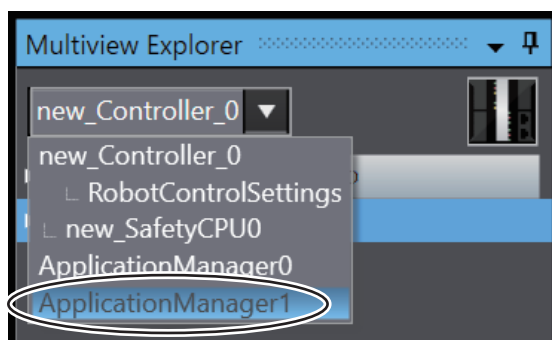

- 2 Double-click **Settings** under **Configurations and Setup** in Multiview Explorer.

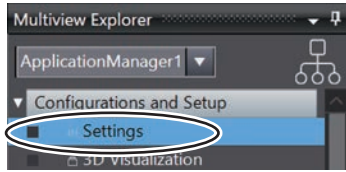

The **Settings** tab page is displayed.

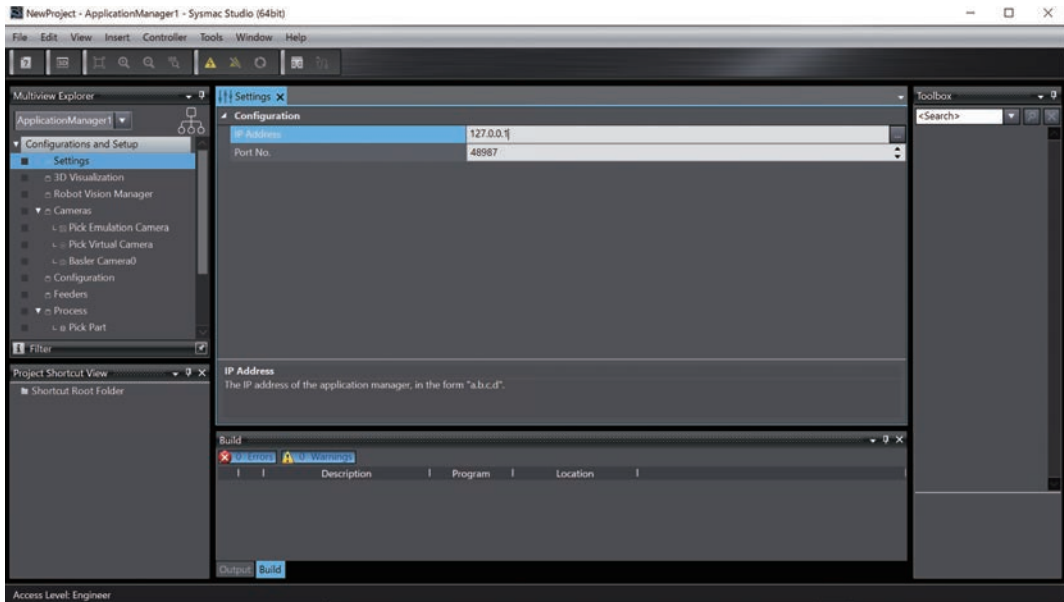

**3** Click the ... button on the right of the **IP Address** row.

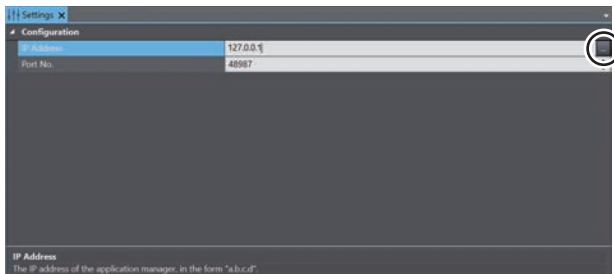

The **Select a controller address** dialog appears.

**4** Click the row where the IP Address of the IPC Application Controller is listed.

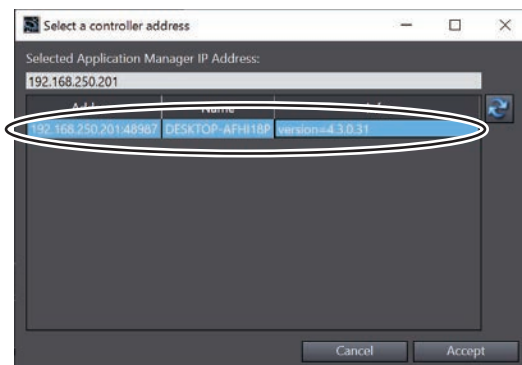

- 5 Click the **Accept** button.

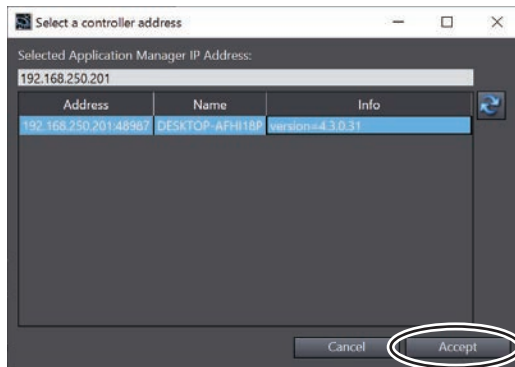

The **Select a controller address** dialog is closed.

## 4-5-2 Online Connection

### Connecting Sysmac Studio to the Robot Integrated CPU Unit Online

Establish an online connection between Sysmac Studio and the Robot Integrated CPU Unit.

- 1 In the Multiview Explorer, select **new\_Controller\_0** from the device list.

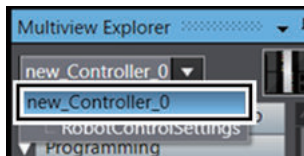

- 2 Click **Controller - Online** from the menu bar.

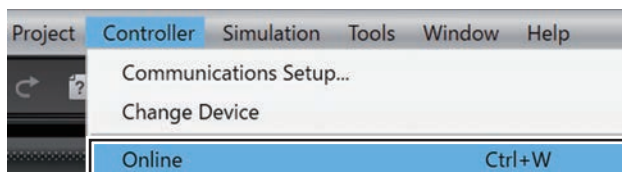

#### Additional Information

Depending on the status of the connected Robot Integrated CPU Unit, the dialog box for writing the CPU Unit name or checking the serial number is displayed. Refer to *Sysmac Studio Version 1 Operation Manual (Cat. No. W504)* for details.

When it is online, the yellow line is displayed on the top of the Edit Pane.



## Going Online with the IPC Application Controller

Connect the IPC Application Controller and Sysmac Studio online.

- 1 Select **ApplicationManager1** from the device list in Multiview Explorer.

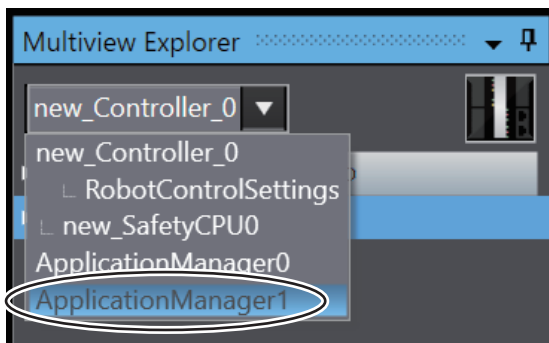

- 2 Click **Controller - Online** from the menu bar.

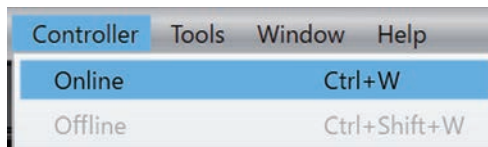

When it is online, the yellow line is displayed on the top of the Edit Pane.



### 4-5-3 Transferring Settings and Programs

To operate a conveyor belt programmatically, download programs and settings in the Sysmac Studio project file to the Robot Integrated CPU Unit.

- 1 In the Multiview Explorer, select **new\_Controller\_0** from the device list.



- 2 Click **Controller - Mode - PROGRAM Mode** from the menu bar.

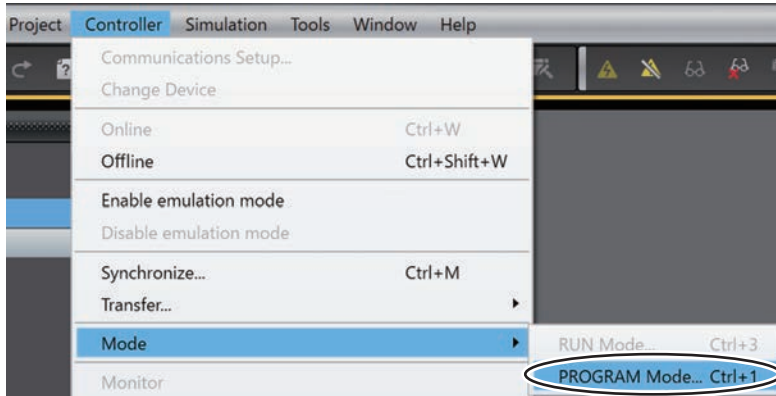

- 3 Follow the instructions in the confirmation dialog, then click the **Yes** button.

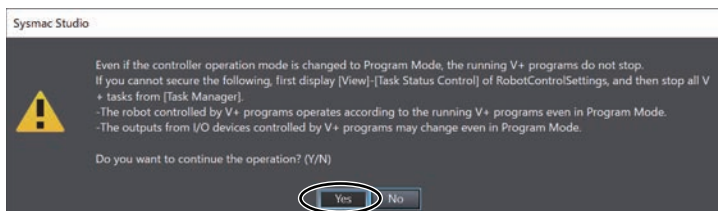

- 4 Select **Controller - Synchronization** from the menu bar on the Sysmac Studio.

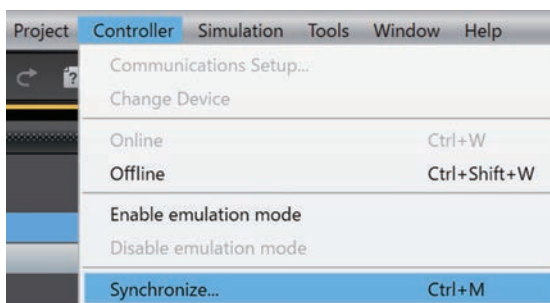

Comparison of programs and settings in Sysmac Studio and the Controller starts. When the comparison is completed, the Synchronization dialog box is displayed.

- 5 Select the check box for **NJ501**.



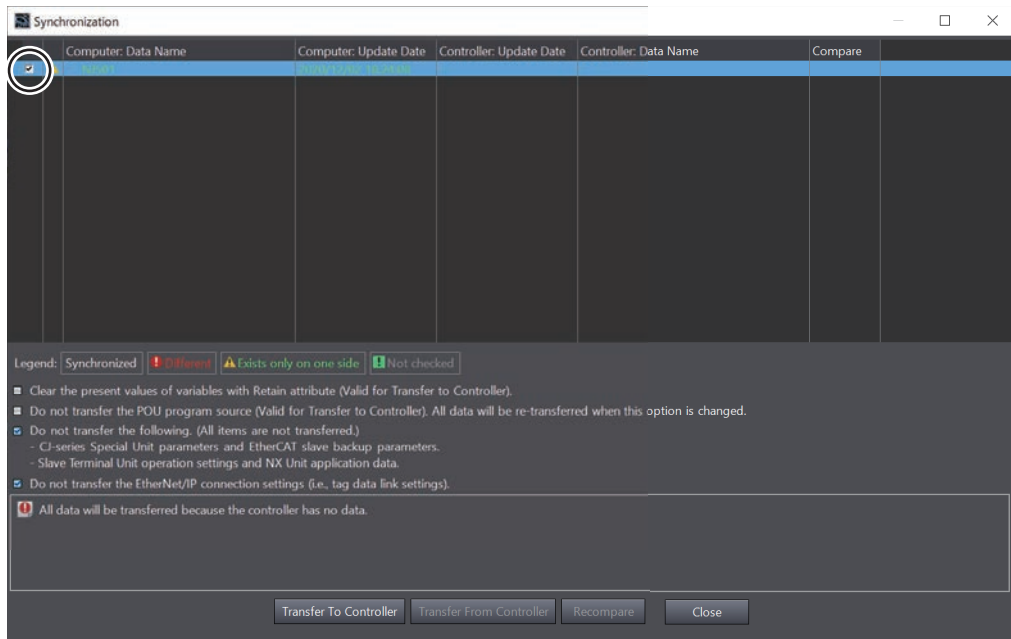

**6** Click the **Transfer to Controller** button.

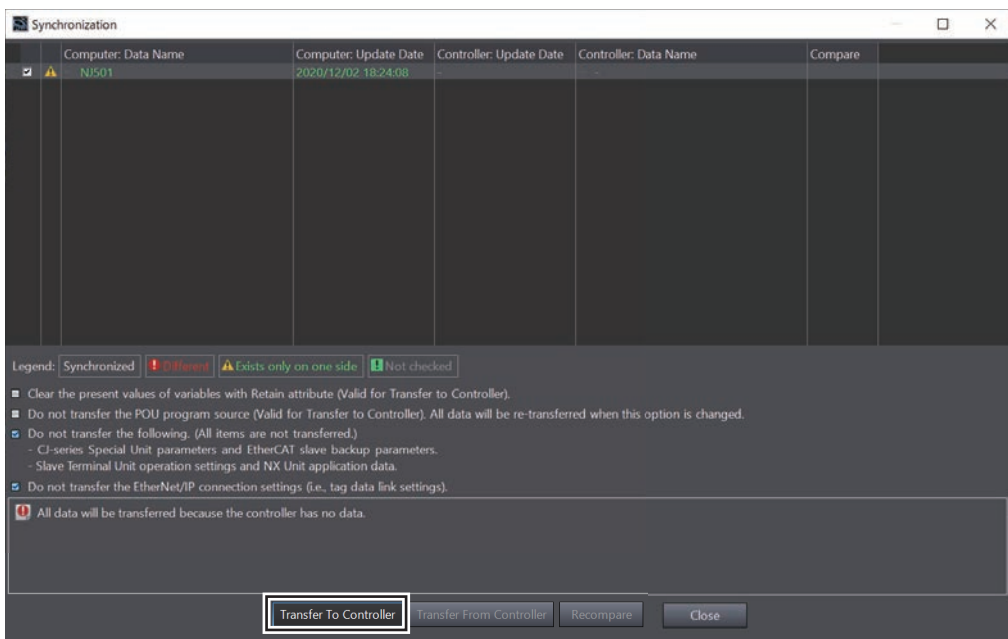

**7** The following confirmation dialog box appears. Click the **Yes** button.

**8** Confirm that the message "The Synchronization process successfully finished" is displayed. Then click the **Close** button.

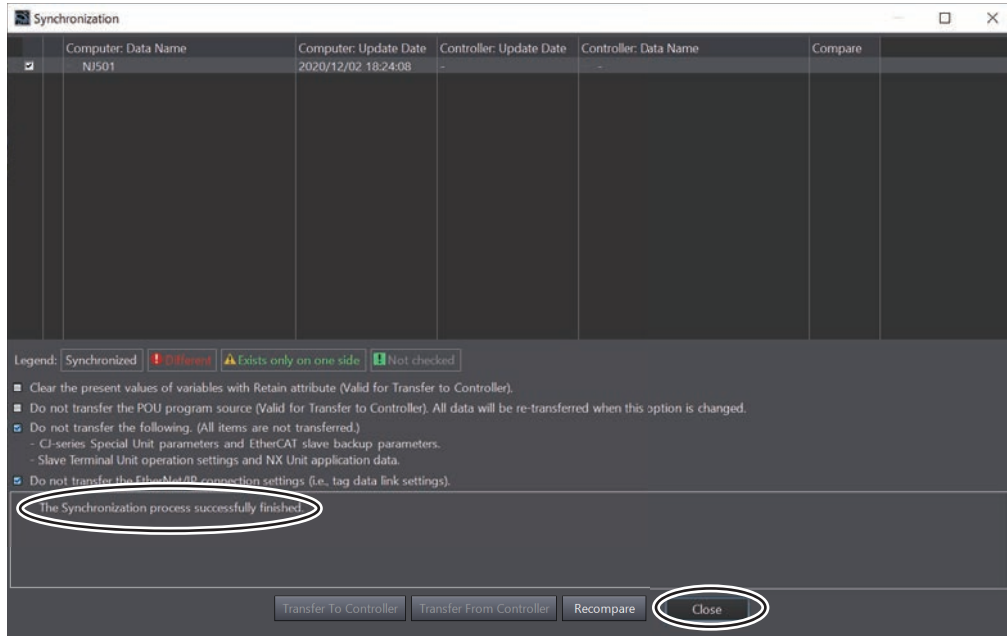

**9** Confirm that the Robot Integrated CPU Unit has started normally. Indicator statuses under a normal operation are given below.

Indicator	Status
RUN indicator	Lit in green
ERROR indicator	Off
NET RUN	Lit in green
NET ERR	Off
LINK/ACT	Blinking

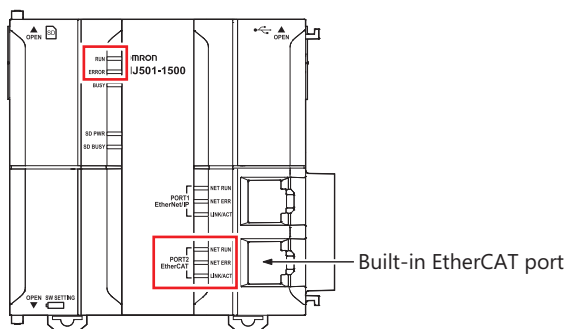

**10** Confirm that the robot has started normally. Indicator statuses under a normal operation are given below.

Indicator	Status
RUN indicator	Lit in green
ERR indicator	Off

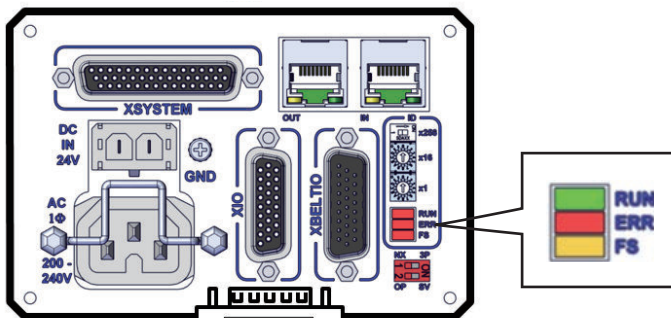

**11** Confirm that the IPC Application Controller has started normally. Indicator statuses under a normal operation are given below.

Indicator	Status
PWR indicator	Lit in green
ERR indicator	Off

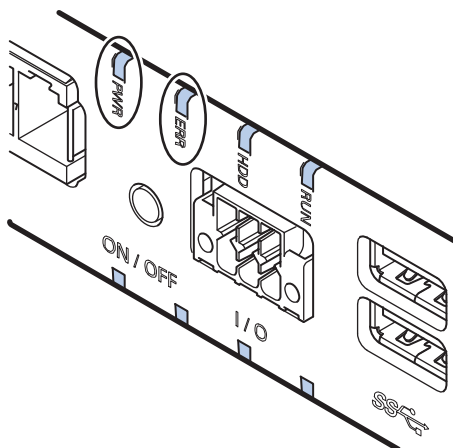

### 4-5-4 Setting up the Camera

#### Adding a Camera to Use

**1** Select **ApplicationManager1** in Multiview Explorer.

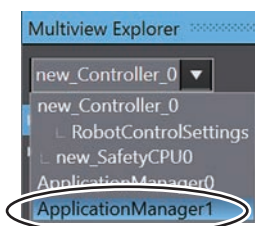

**2** Select a camera type.

- 1) Click **Configurations and Setup** to expand.
- 2) Right-click **Cameras** to display the context menu.

### 3) Select **Add - Basler Camera**.

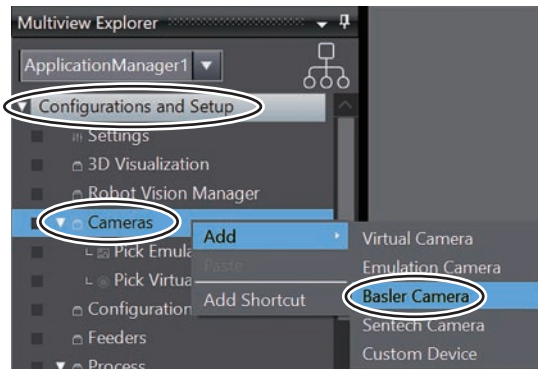

The **Create Basler Device** wizard appears.

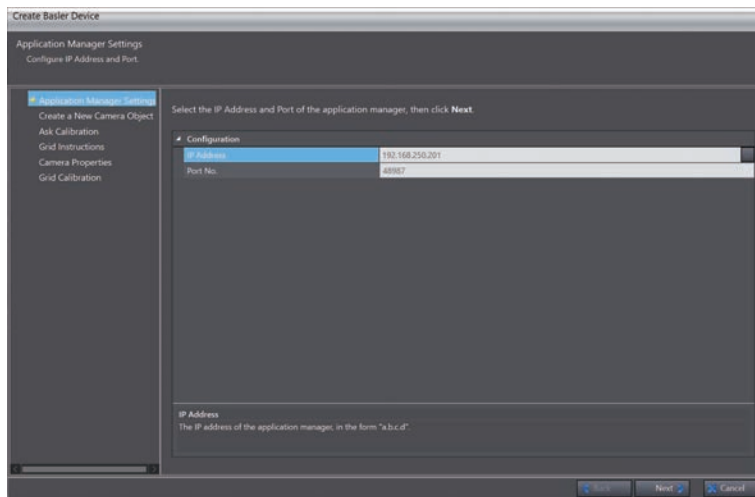

### 3 Make sure that **IP Address** is set to the IP address of the IPC Application Controller and click the **Next** button.

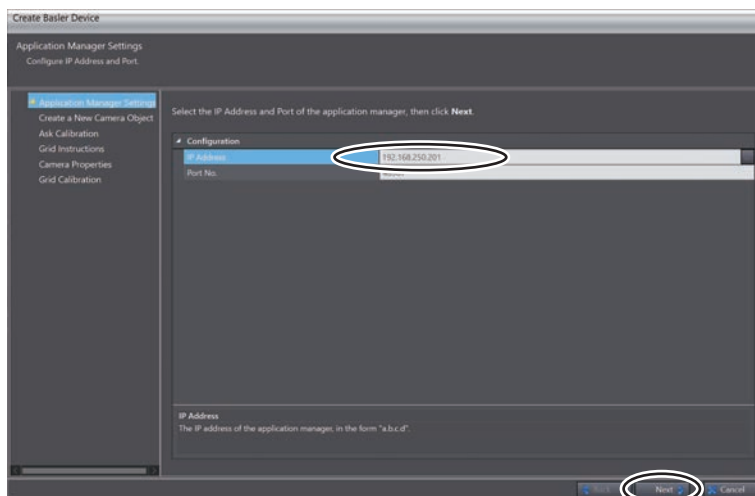

### 4 Select the camera you use from the device list.

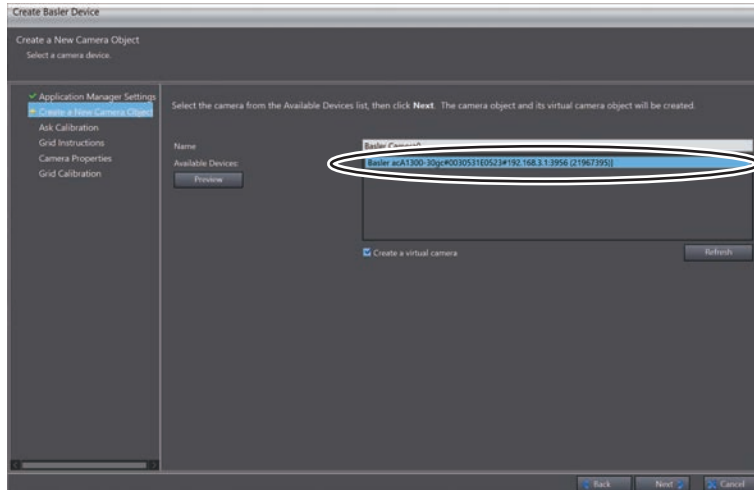

## 5 Clear the **Create a virtual camera** check box.

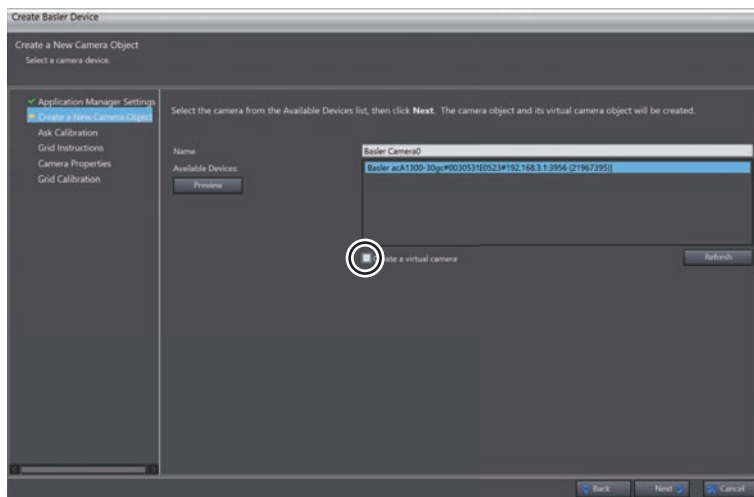

## 6 Click the **Next** button.

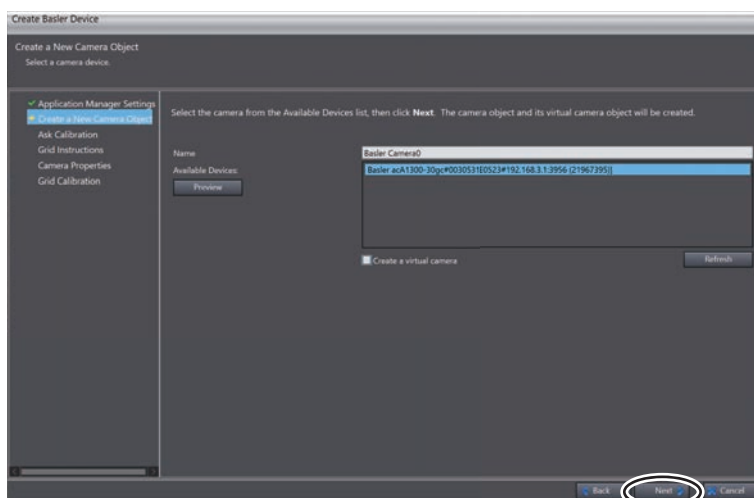

The **Create Basler Device** wizard is closed. **BaslerCamera0** has been added under **Configurations and Setup - Cameras** in Multiview Explorer.

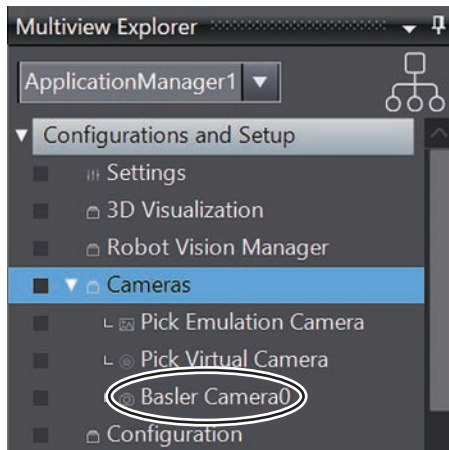

### Designating a Default Device for the Virtual Camera

- 1 Double-click **Pick Virtual Camera** under **Configurations and Setup - Cameras** in Multiview Explorer.

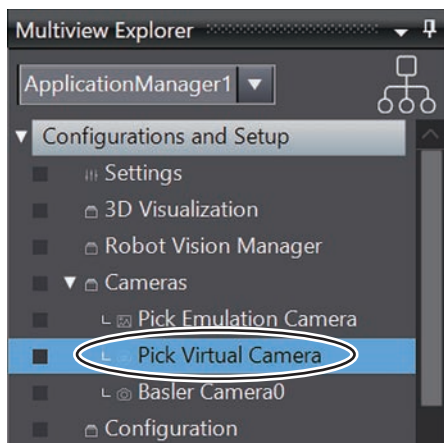

The **Pick Virtual Camera** window is displayed.

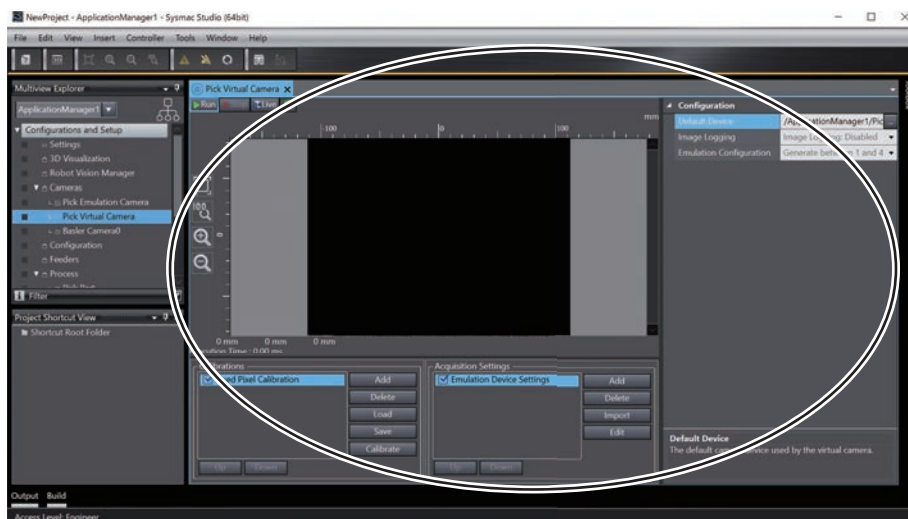

- 2 Click the ... button on the right side of **Default Device** under **Configuration**.

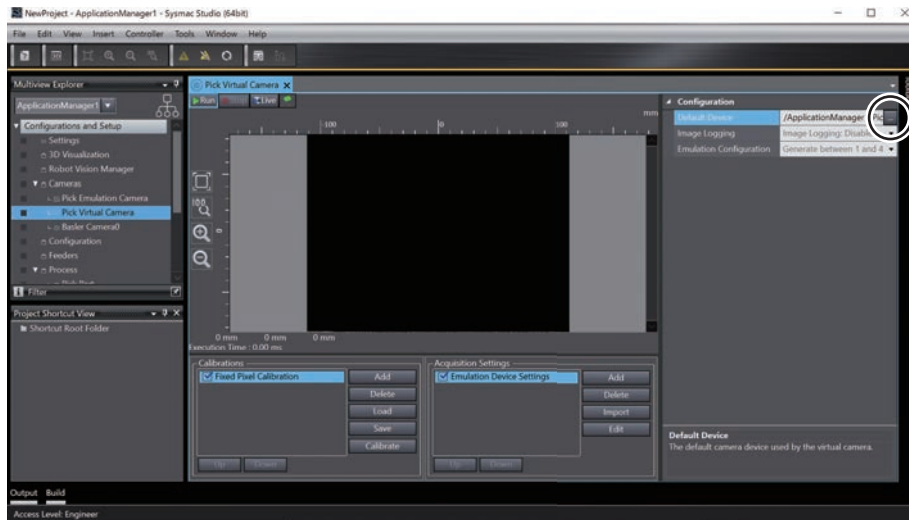

The **Select a Reference** dialog appears.

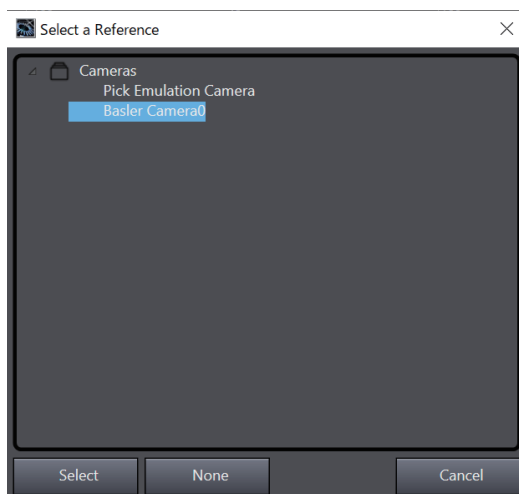

- 3 Click **Basler Camera0**.

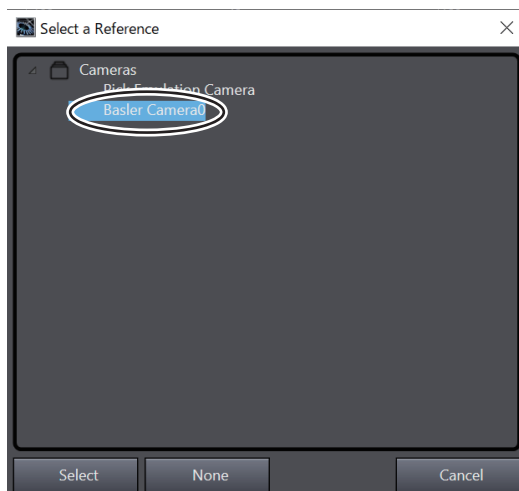

#### 4 Click the **Select** button.

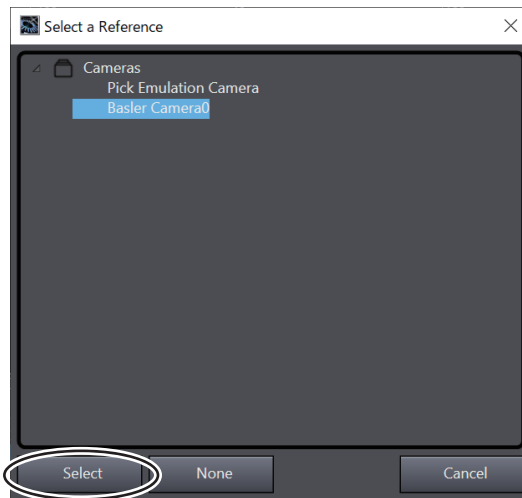

The **Select a Reference** dialog is closed, then **Basler Camera0** is shown in **Default Device** under **Configuration**.

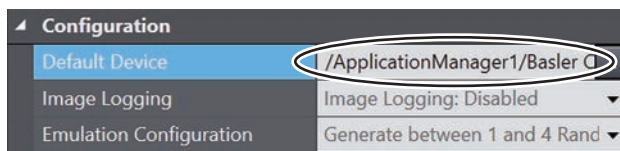

## Adding Acquisition Settings

#### 1 Click the **Add** button in the **Acquisition Settings** area.

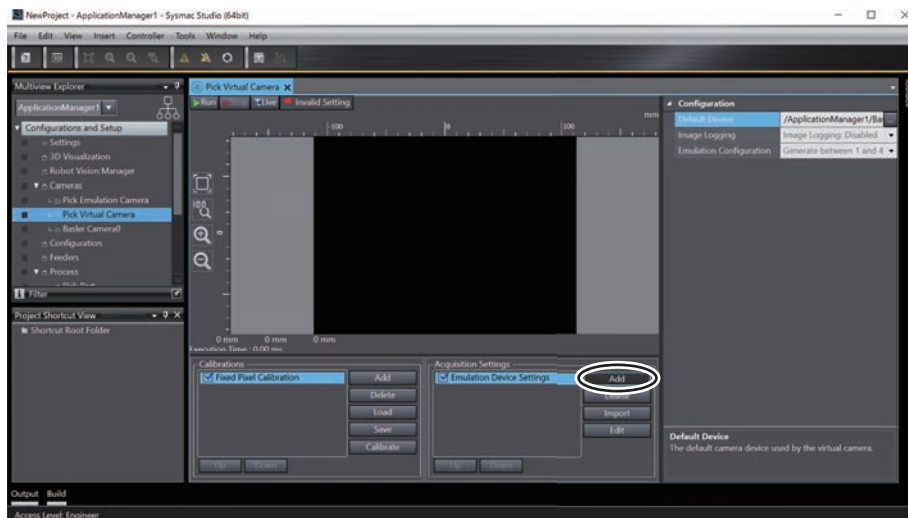

The **Camera Properties** dialog box is displayed.

#### 2 Click the **Accept** button.



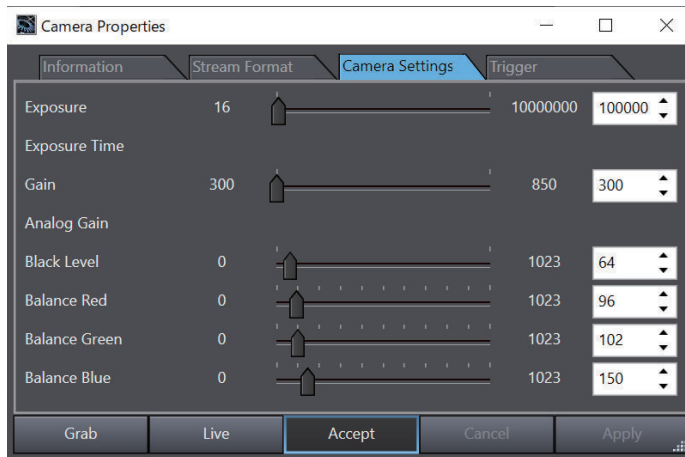

Basler Pylon acA1300-30gc Device Settings is added.

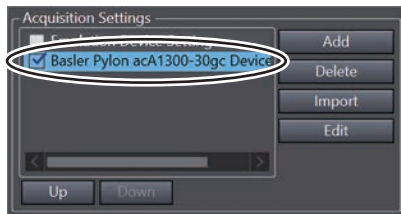

An image taken by the camera can be shown.

For example, the display is seen as illustrated below when the calibration grid is in the shooting range.

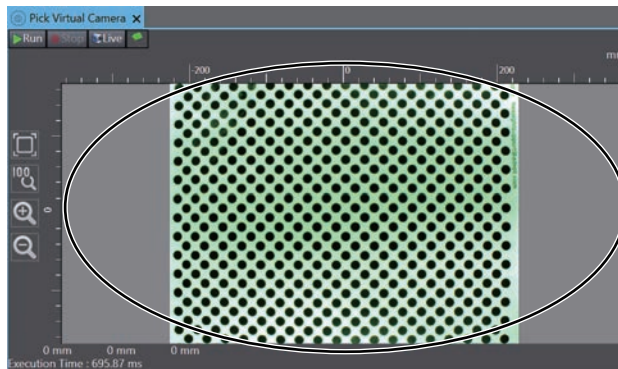

## Adding the Grid Calibration

- 1 Click the **Add** button in the **Calibration** area.

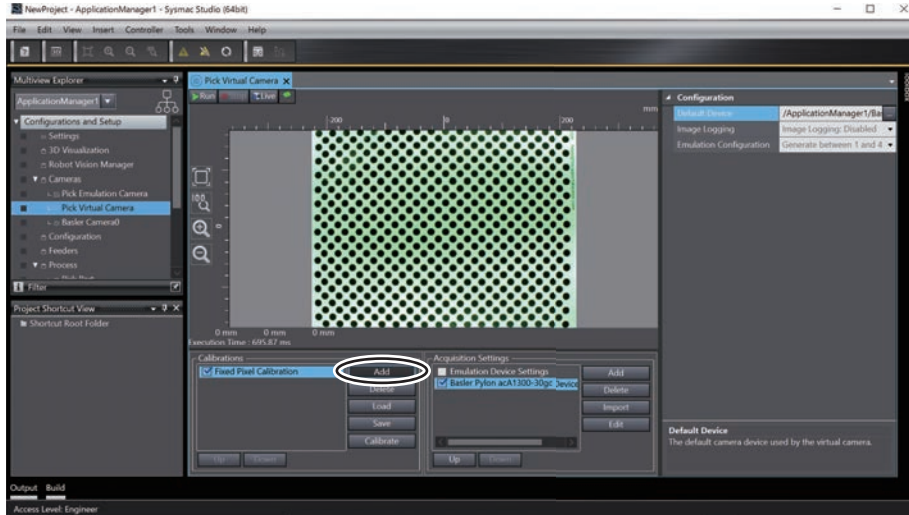

The **Select A New Calibration Type** dialog appears.

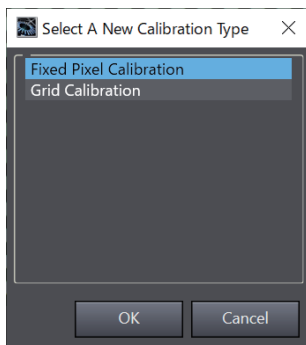

**2** Select **Grid Calibration** and click the **OK** button.

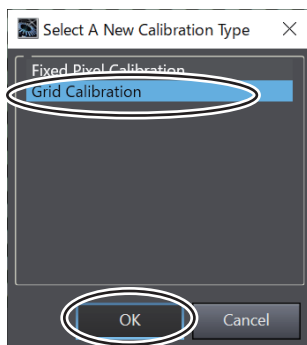

The **Grid Pixel Calibration** dialog is displayed.

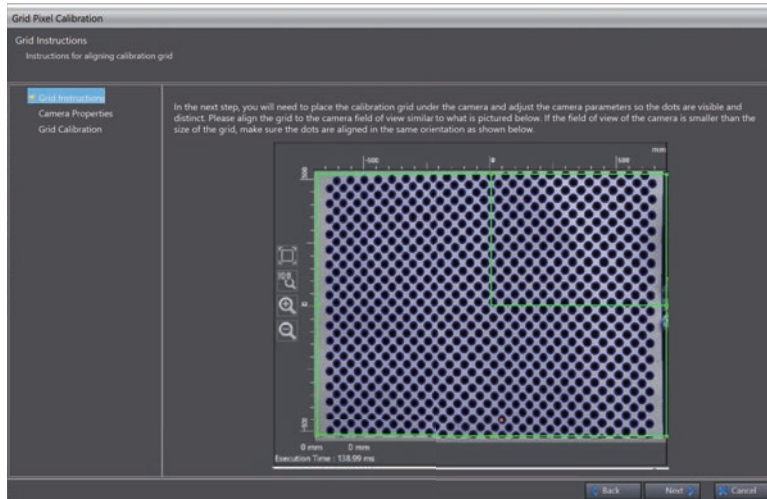

**3** Click the **Next** button.

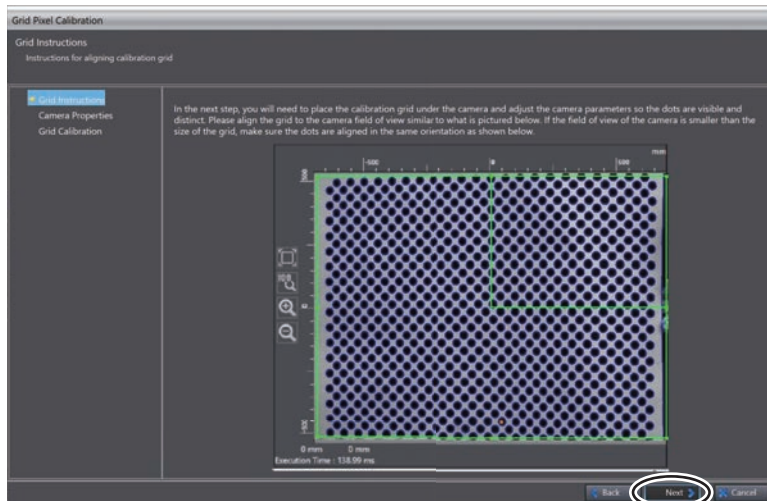

The calibration grid taken by the camera is shown.

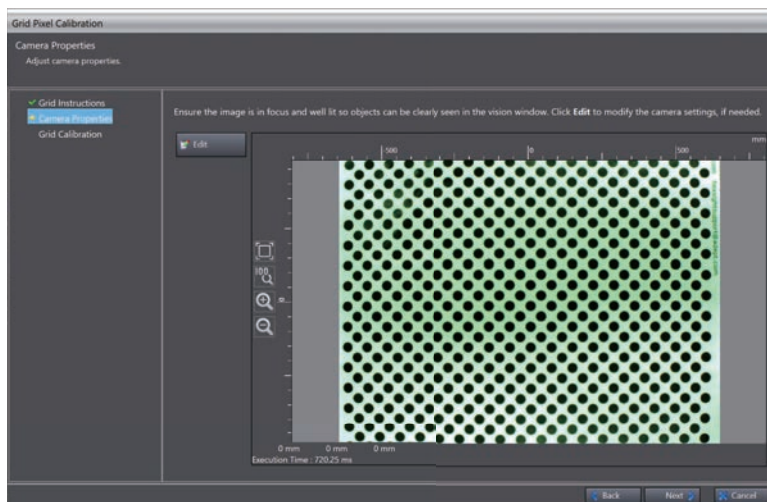

**4** Check the calibration position, focus, and light. If necessary, adjust each element.

**4**

5 Click the **Edit** button if dots are not clearly displayed.

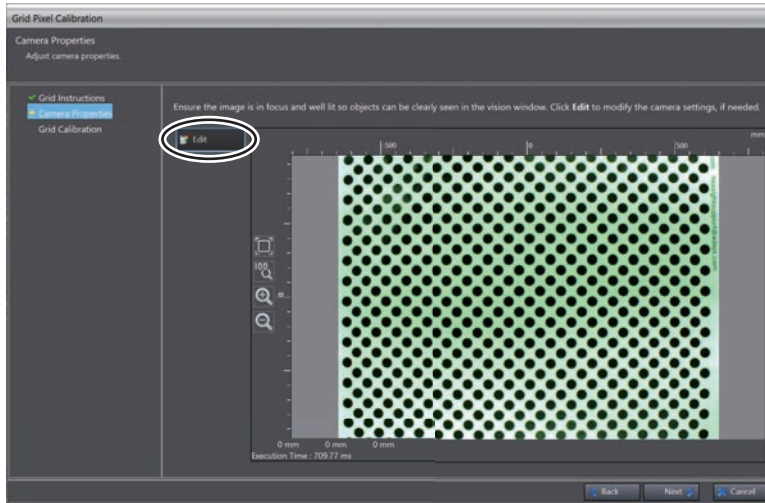

The **Camera Properties** dialog is shown. Configure properties so that dots get clear. Then click the **Accept** button to close the **Camera Properties** dialog.

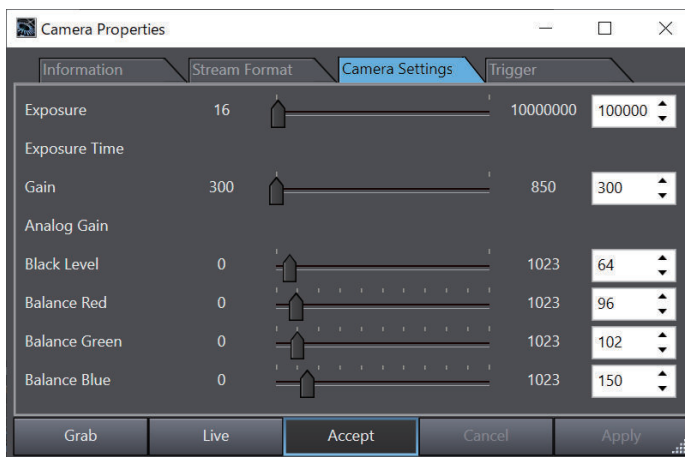

6 Click the **Next** button.

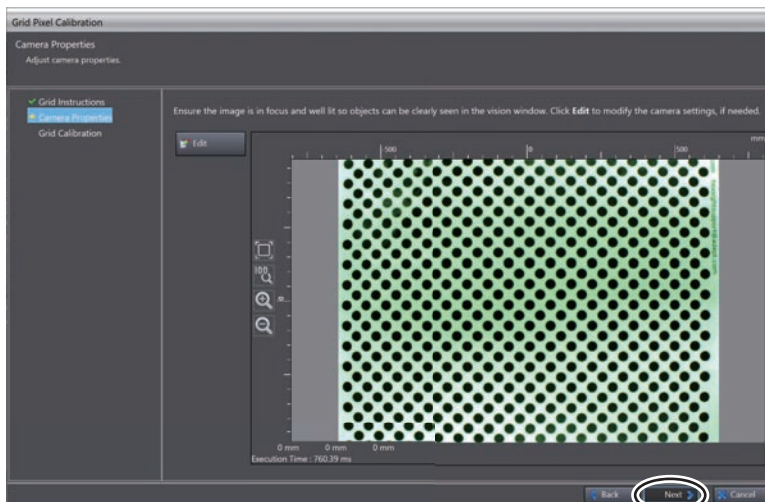

The dialog for grid calibration is displayed.

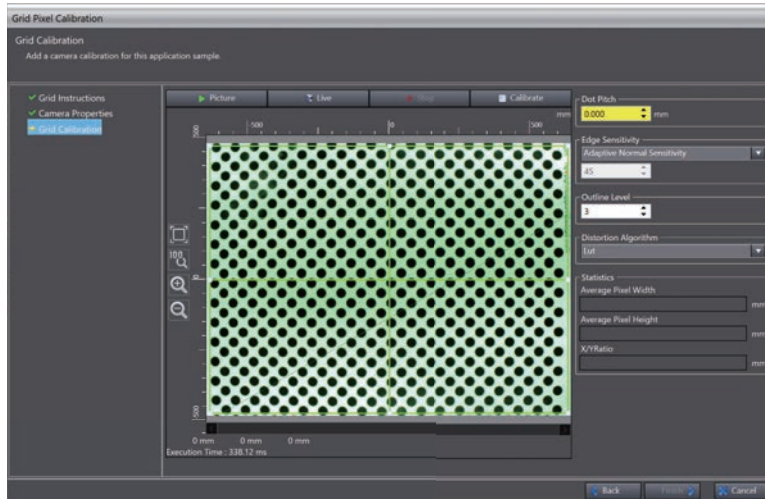

- 7 Enter a dot pitch value of the calibration grid in use into the **Dot Pitch** box.

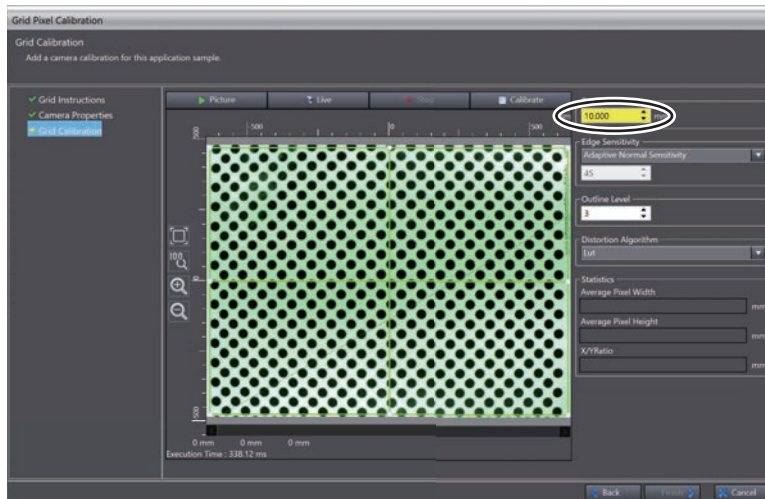

In this manual, 10.00 is entered in the box because the calibration grid whose dot pitch is 10 mm is used to explain the procedure.

- 8 Click the **Calibration** button.

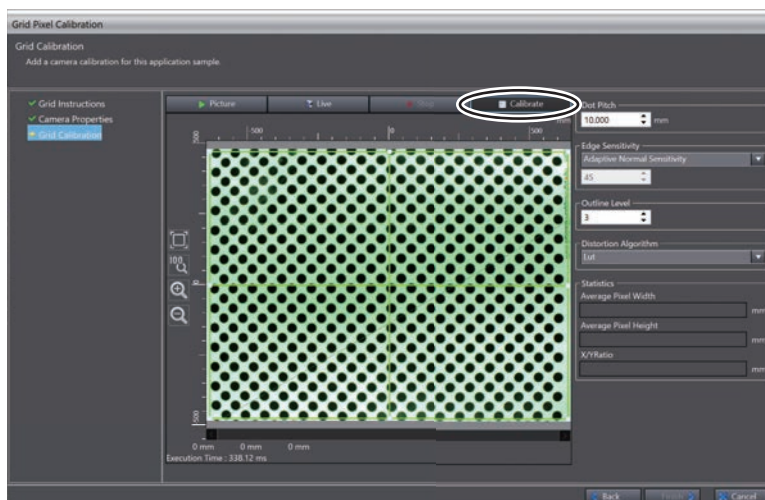

Calibration is performed.

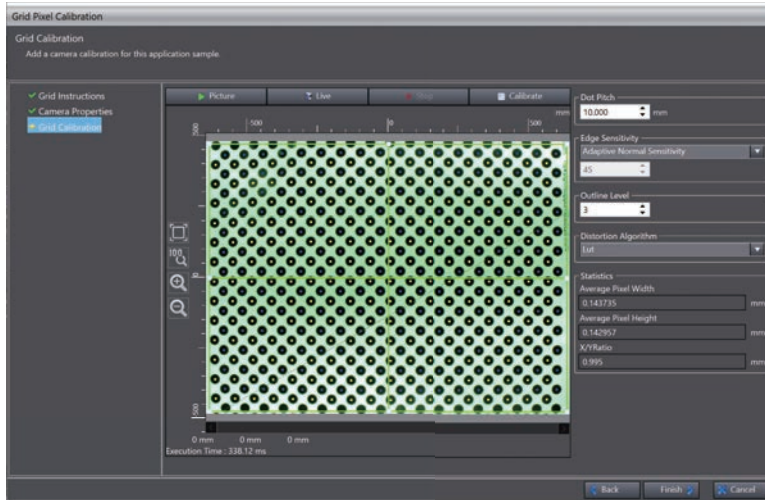

Yellow points in the black dots mean the calibration has been successfully done. If yellow points are not shown, click the **Back** button to return to Step 4, then re-adjust properties so that the dots get clear.

### 9 Click the **Finish** button.

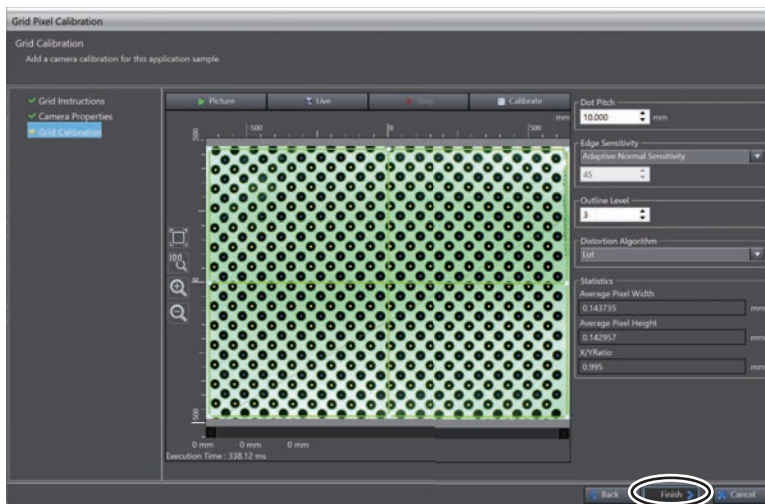

The **Grid Pixel Calibration** dialog is closed.

## 4-5-5 Running a Sequence Control Program and V+ Program

To operate the conveyor belt for a calibration, run a sequence control program and V+ program.

- 1 Select **Operation Mode - RUN Mode** from the **Controller** menu.
- 2 Select **View - Task Status Control** from the menu bar.

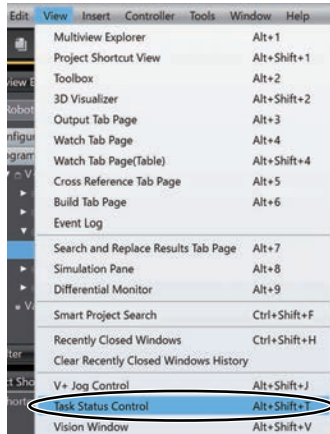

The **Task Status Control** pane is displayed.

- 3 Select **RobotControlSettings** from the device list in the Multiview Explorer.

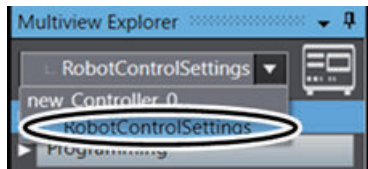

- 4 Right-click **Programming - V+ Modules - supervisor - supervisor**, then click **Execute on Task - Task 2**.

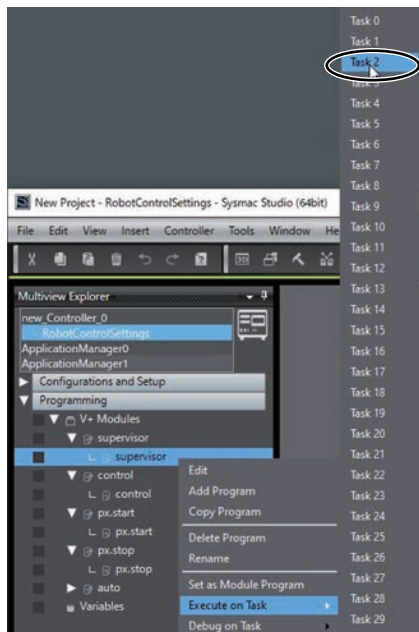

The supervisor and control of the V+ program is executed in Task2 and Task 3 respectively.

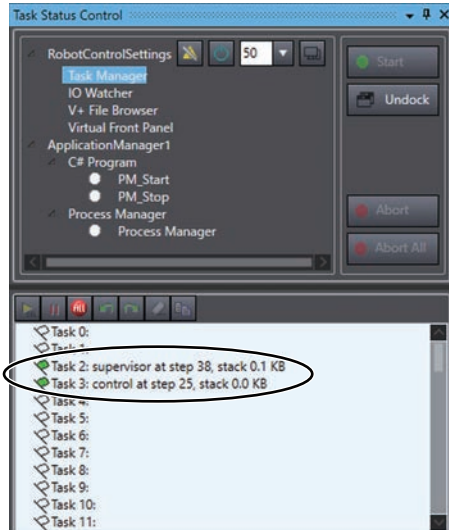

- 5 Select **Watch Tab Page** from the **View** menu on the main window.

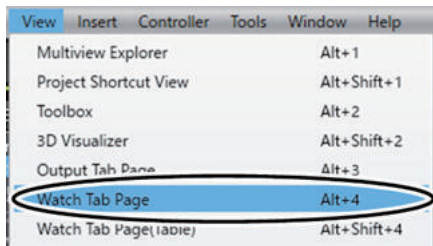

The **Watch (Project)1** tab page appears at the bottom of the main window.

- 6 Click the **TRUE** button in the **Modify** column for the variable **gStart** in the **Watch (Project)1** tab page.

Watch (Project)1					
Device name	Name	Online value	Modify	Comment	D
new_Controller_0	gStart	False	<b>TRUE</b> FALSE	Auto start Button	BC
new_Controller_0	Input Name...				

The program runs.

### 4-5-6 Turning Robot High Power ON

The robot high power is turned ON.

- 1 Change the operating mode switch on the front panel to Manual Mode.



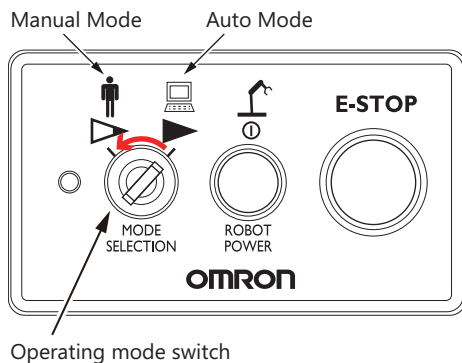

- 2** Press the enable switch on the T20 pendant to Position 2 (half-way).



- 3** Press the Robot Power button while the enable switch is kept in Position 2 (half-way).



The Robot Power button on the front panel flashes.

- 4** Press the Robot Power button on the front panel.  
The robot high power is turned ON and the Robot Power button is lit.

If you release the enable switch (Position 1) or press the enable switch further from Position 2 (half-way) to Position 3, the robot high power will be turned OFF.



**Precautions for Correct Use**

If it is necessary to move the robot, follow the procedure above to turn ON the high power.

**4-5-7 Calibrating the Belt**

Calibrate the belt.

- 1 Select **ApplicationManager1** from the device list in Multiview Explorer.



- 2 Double-click **Process Manager** under **Configurations and Setup - Process** in Multiview Explorer.

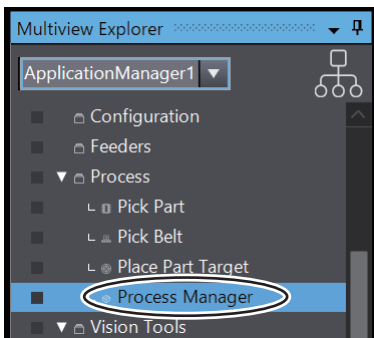

The **Process Manager** tab page is displayed.

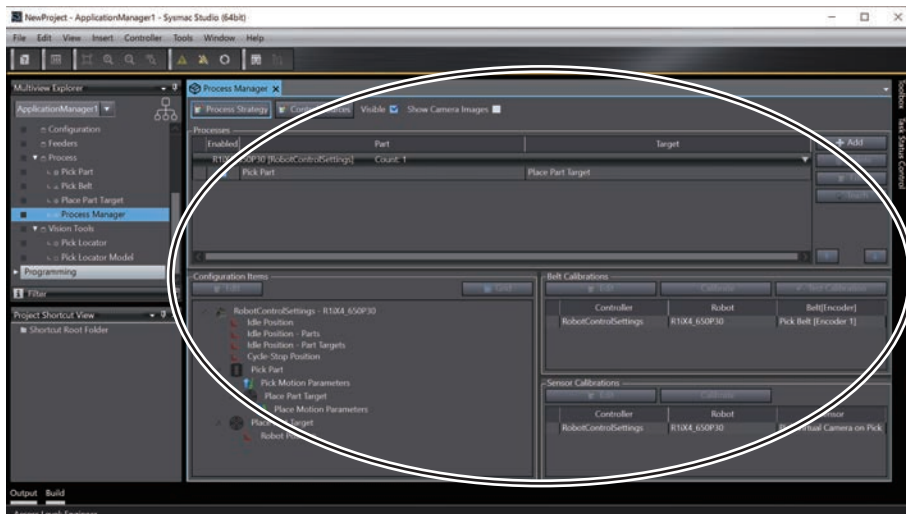

- 3 In the **Belt Calibrations** pane, click the row where the belt you calibrate is.

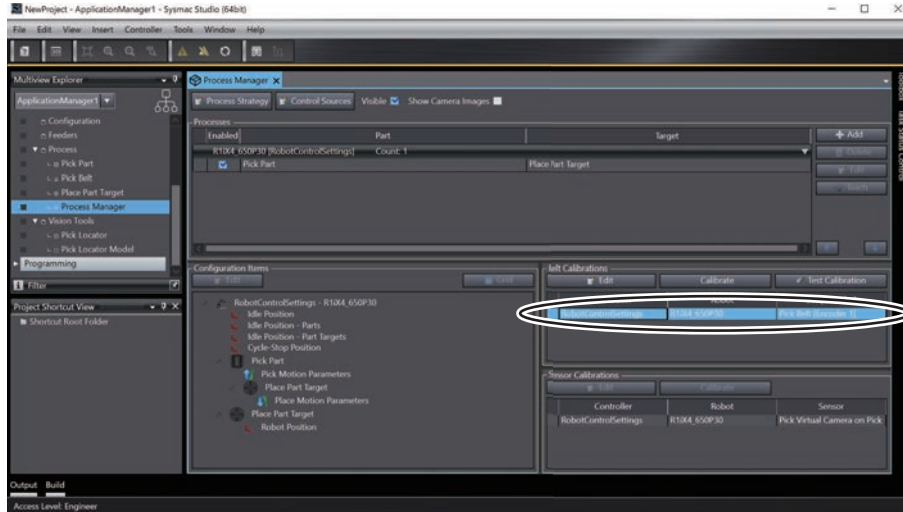

4 Click the **Calibrate** button in **Belt Calibrations**.

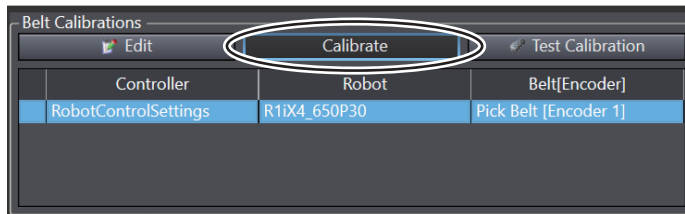

The **Robot-to-Belt Calibration Sequence** dialog is displayed.

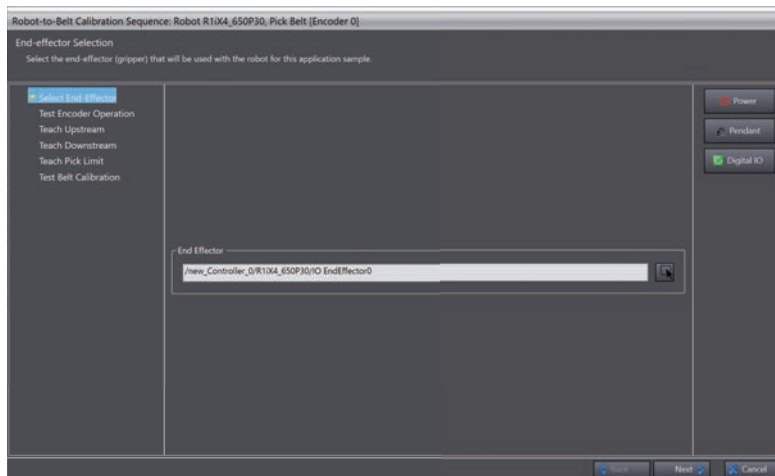

5 Make sure that the right end effector has been selected , and then click the **Next** button.

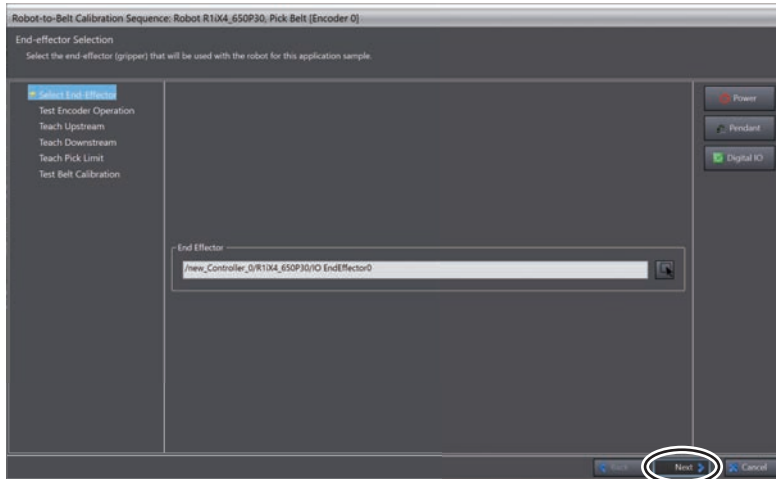

6 Click the **On/Off** lamp to lit.

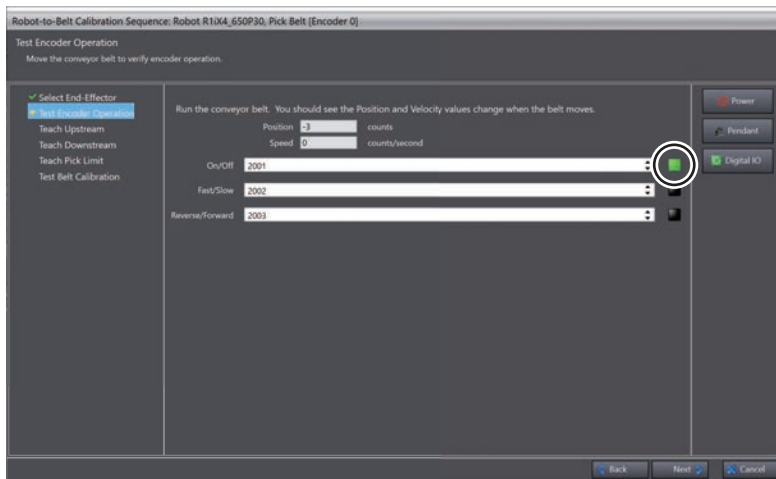

Confirm the conveyor belt moves and the number of counts of the **Position** box changes.

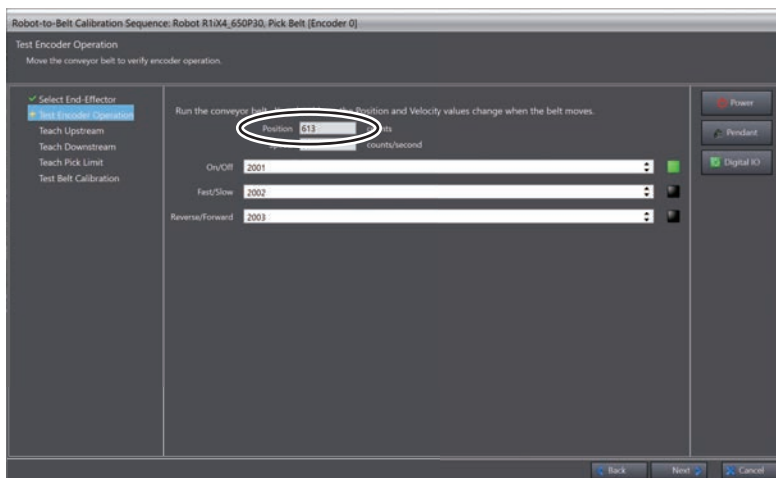

7 Click the **On/Off** lamp to turn off the light.  
The conveyor belt stops and also the counter of **Position** stops.

- 8** Click the **Next** button.  
The Teach Upstream Limit dialog appears.

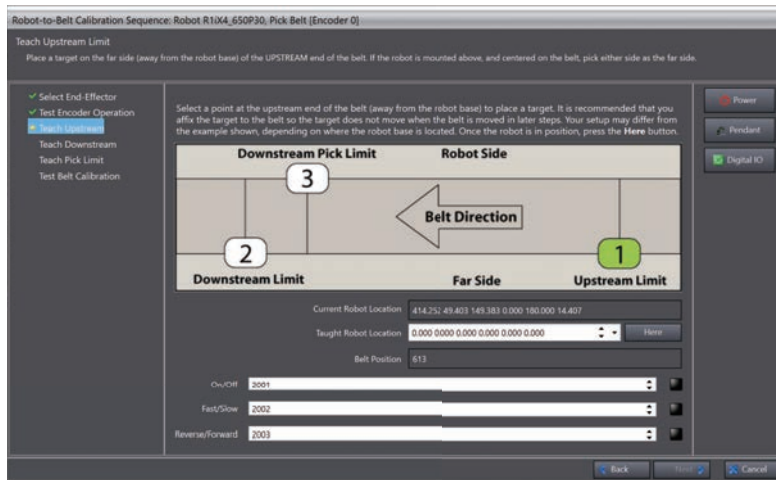

- 9** Put the target on the upstream limit point on the belt.  
**10** Operate the robot with the T20 Pendant to move it to the upstream limit point.



#### Additional Information

It is also possible to move the robot in the **V+ Jog Control** window, which is displayed through a click of the **Pendant** button.

- 11** Click the **Here** button.

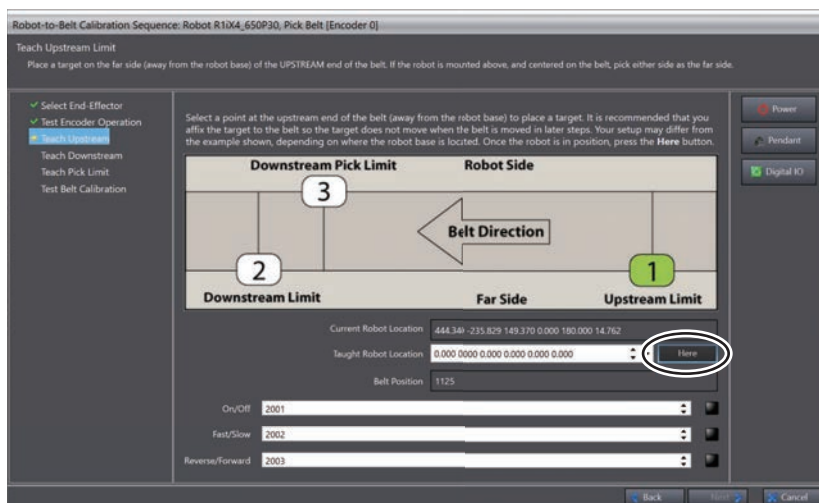

The present robot position is set to the **Taught Robot Location** box.

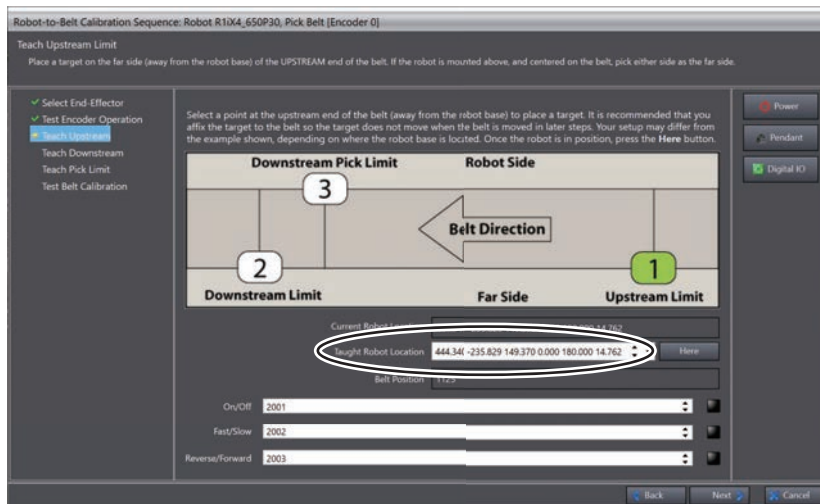

**12** Click the **Next** button.

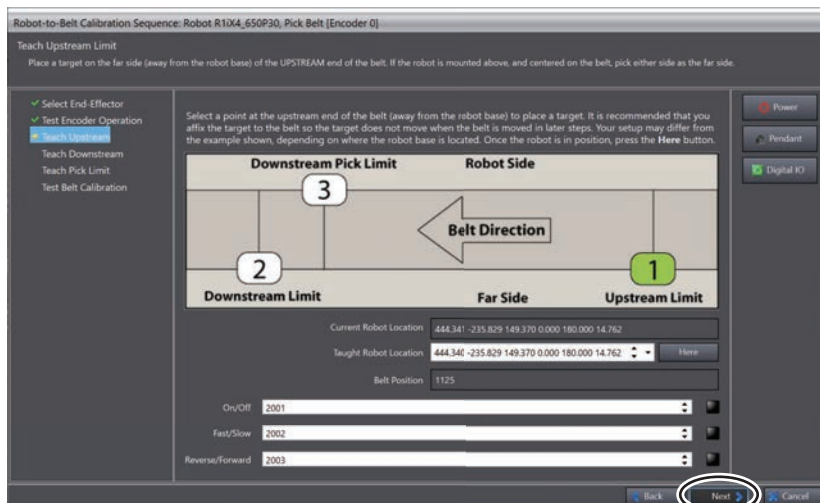

**13** Click **On/Off** and **Reverse/Forward** lamps to move the belt so that the target reaches to the downstream limit point.



**14** Teach the robot the downstream limit in the same way as shown in Step 10 to 12.

**15** Click **On/Off** and **Reverse/Forward** lamps to move the belt so that the target reaches to the pick limit point.

**16** Teach the robot the pick limit in the same way as shown in Step 10 to 12.

- 17** Change the operating mode to Auto mode from Manual mode on the front panel, and click the **Power** button. When the Robot Power button on the front panel flashes, press it to turn on the robot high power.
- 18** Move the robot to the upstream of the belt, then click the **Start Tracking** button in **Belt Transform** in the **Test Belt Calibration** window.

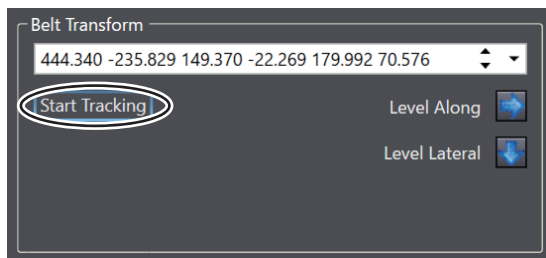

The robot moves as the belt moves.

- 19** Click the **Stop Tracking** button if you have confirmed the robot moved as the belt moved.

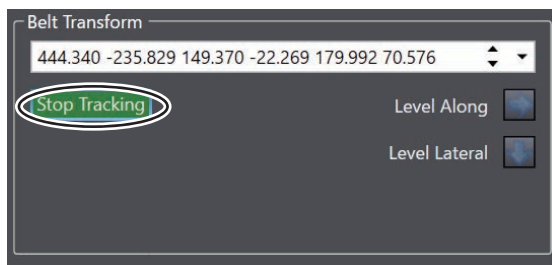

The tracking operation stops.

- 20** Click the **Finish** button.  
The **Robot-to-Belt Calibration Sequence** dialog is closed.

## 4-5-8 Calibrating the Sensor

Calibrate the sensor.



### Additional Information

- The procedure in this section includes steps for detecting the target. It is for position detection required for calibration of the sensor. For settings of the locator model to detect an actual target, refer to *4-5-9 Setting the Locator* on page 4-146.
- If the target cannot be detected, adjust the camera's shooting environment or the acquisition settings. Refer to the *Automation Control Environment (ACE) Version 4 User's Manual (Cat. No. I633)* for information on the acquisition settings of the virtual camera.

- 1** Select **ApplicationManager1** from the device list in Multiview Explorer.



- 2 Double-click **Process Manager** under **Configurations and Setup - Process** in Multiview Explorer.

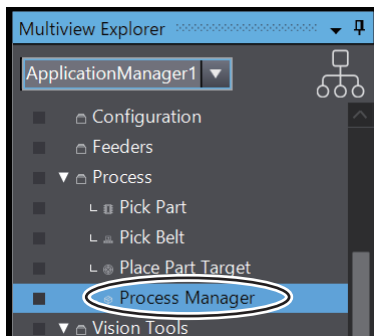

The **Process Manager** tab page is displayed.

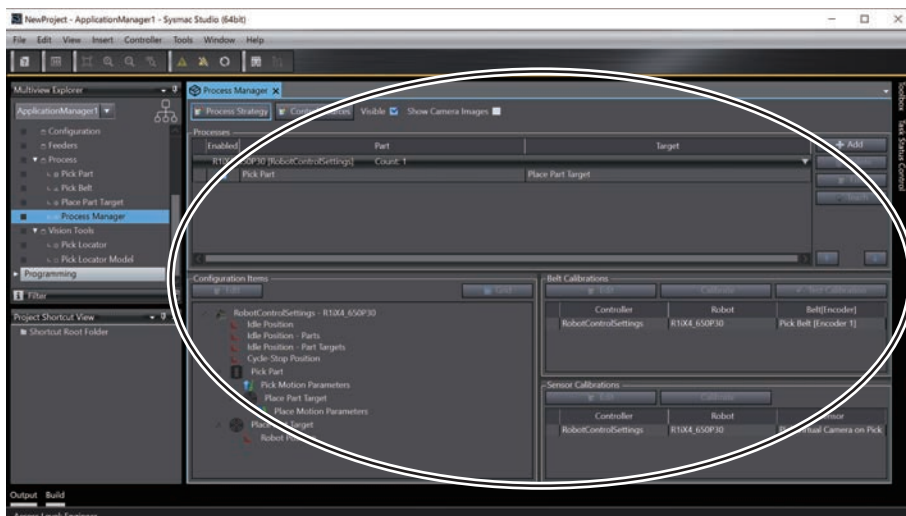

- 3 In the **Sensor Calibrations** pane, click the row where the sensor you calibrate is.



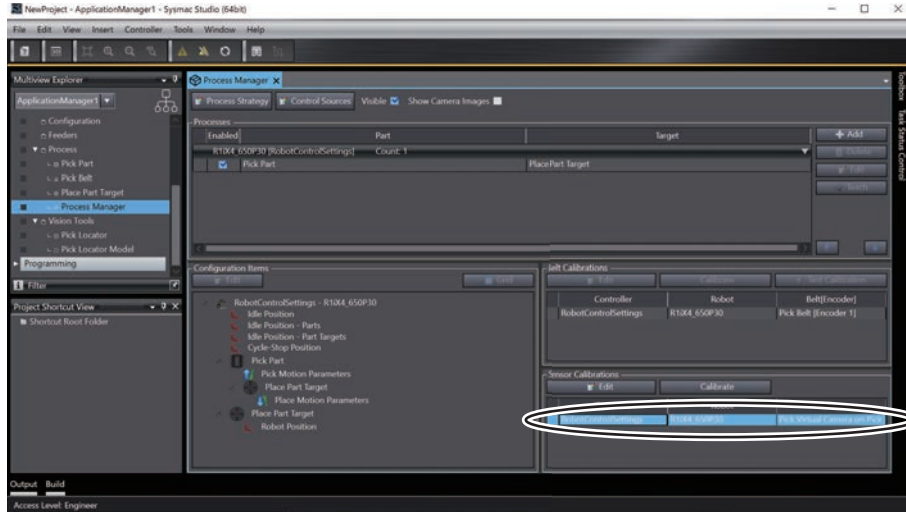

4 Click the **Calibrate** button in **Sensor Calibrations**.

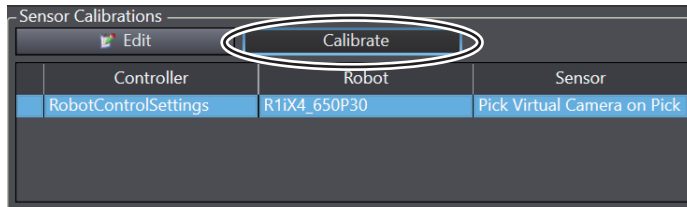

The **Robot-to-Belt Camera Calibration Sequence** dialog is displayed.

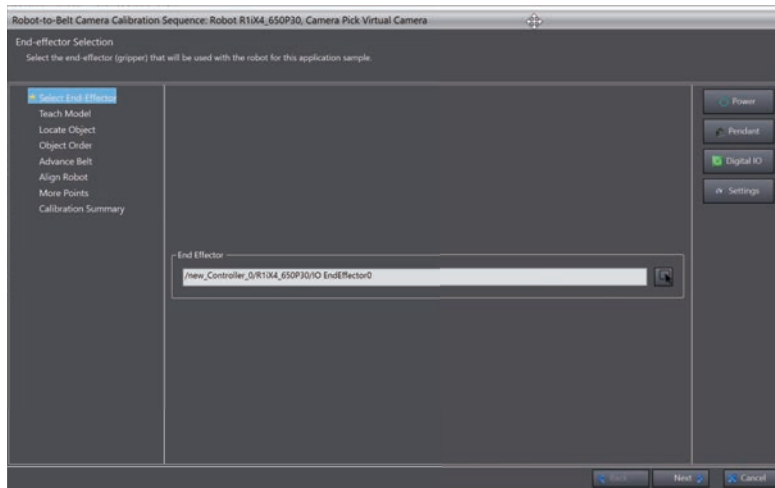

5 Make sure that the right end effector has been selected , and then click the **Next** button.

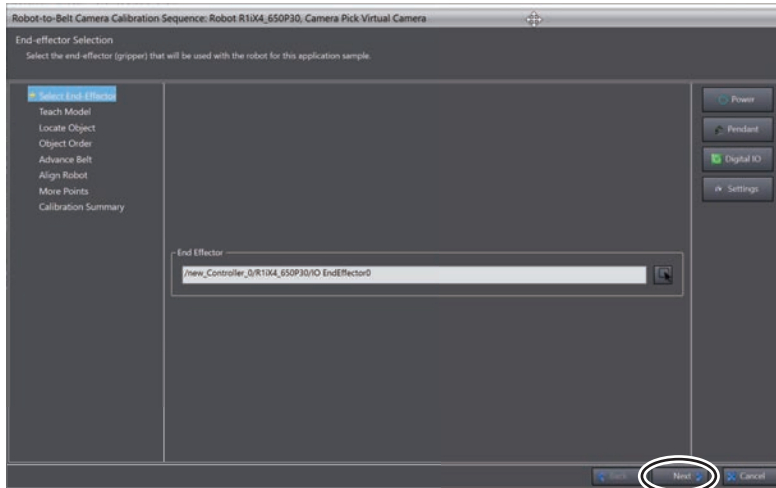

- 6 Click the **Live** button and place the target in the camera view while watching the displayed image.

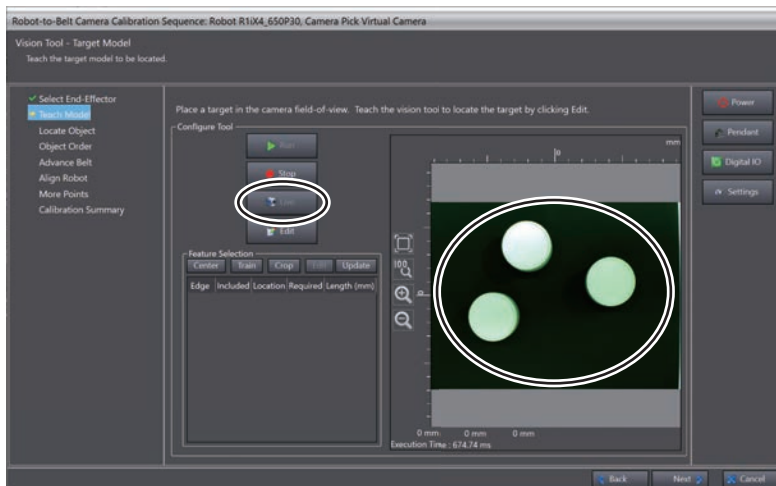

- 7 Click the **Stop** button.

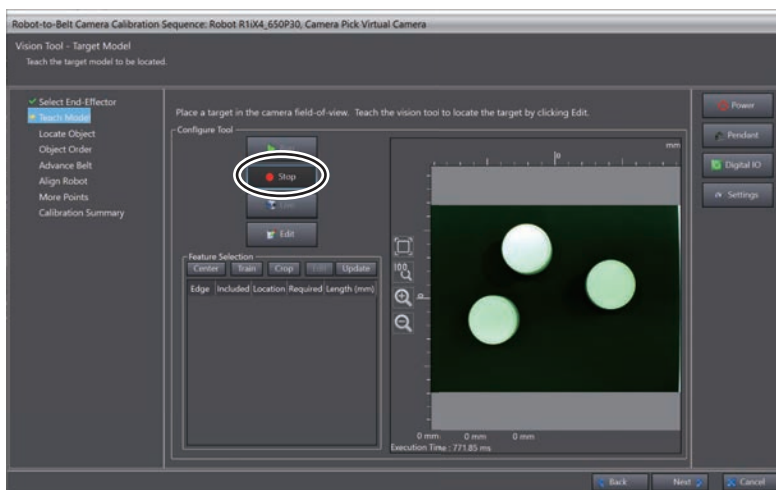

The green frame which specify a target is shown.

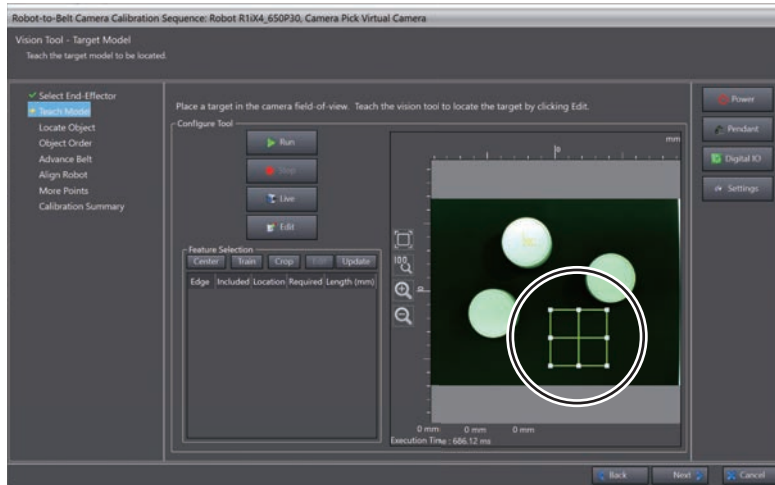

8 Drag and drop the green frame, and scale it to box a target.

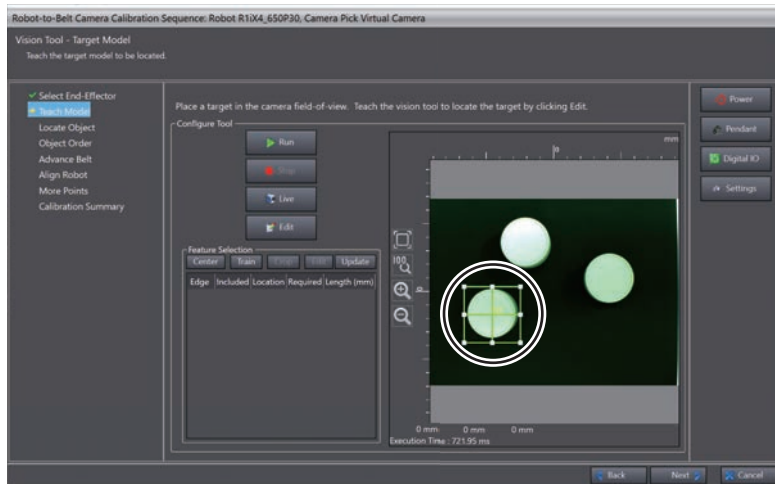

9 Click the Run button.

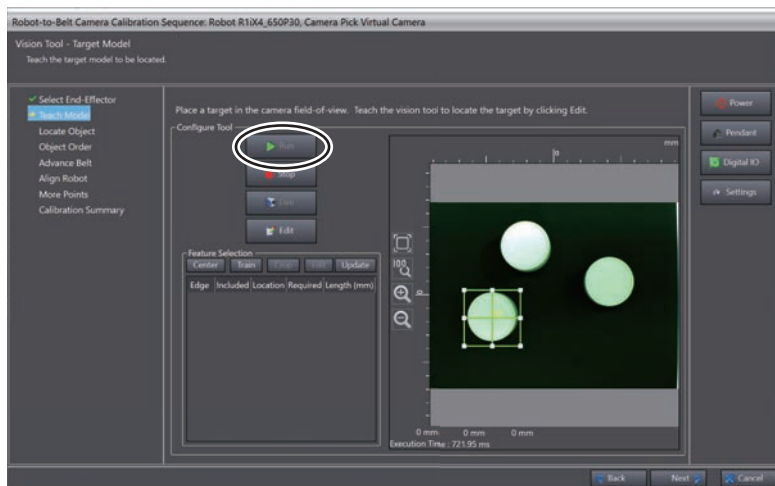

Features of the boxed target are detected.

## 4 Implementation Example of Dynamic Pick-and-place Equipment

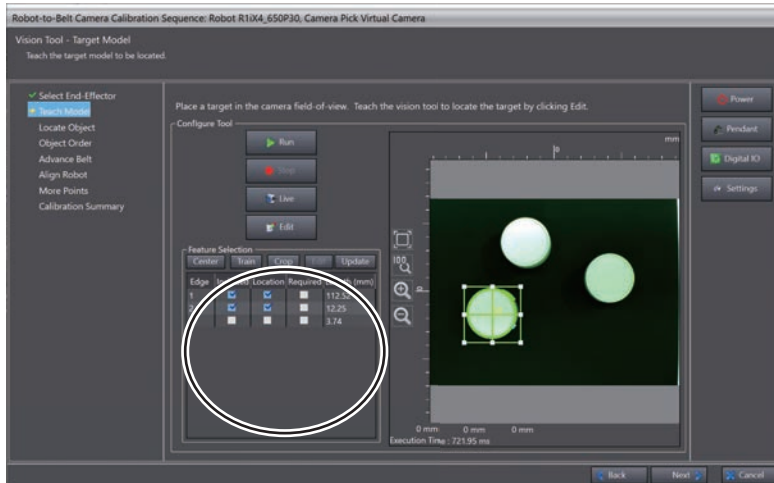

**10** Click the **Crop** button.

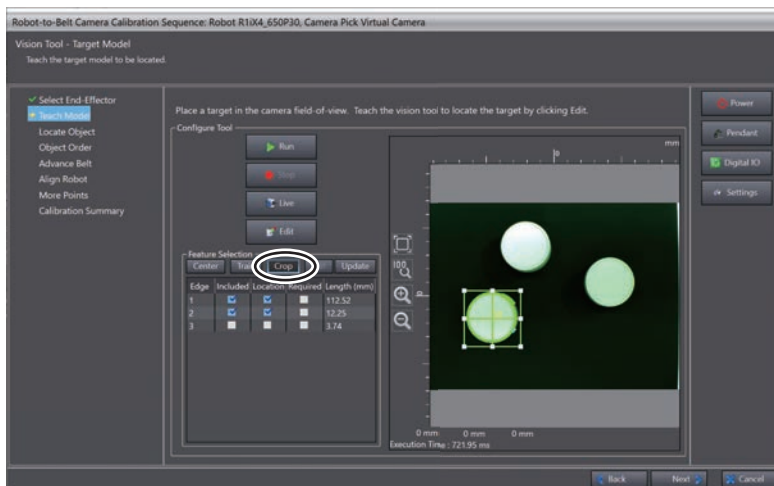

The boxed target is displayed in an enlarged image.

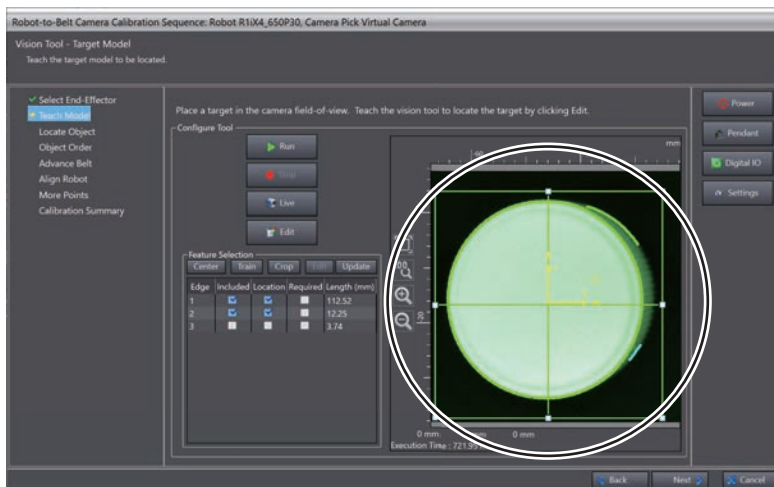

**11** Click the **Center** button.

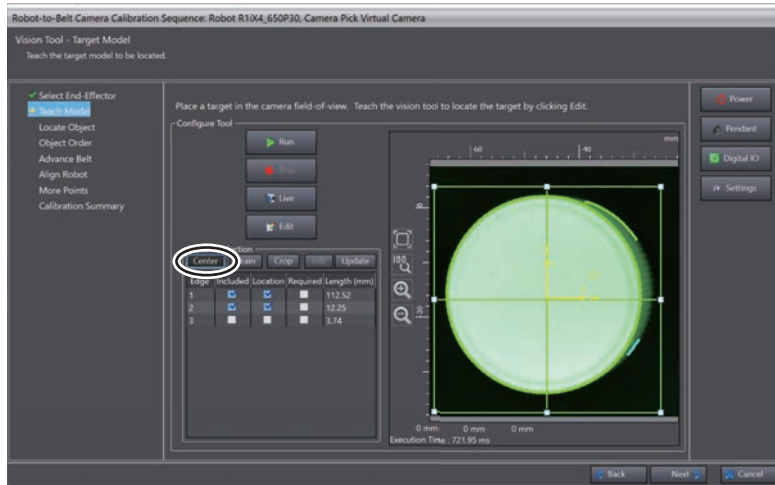

A yellow marker is displayed at the center of the detected target.

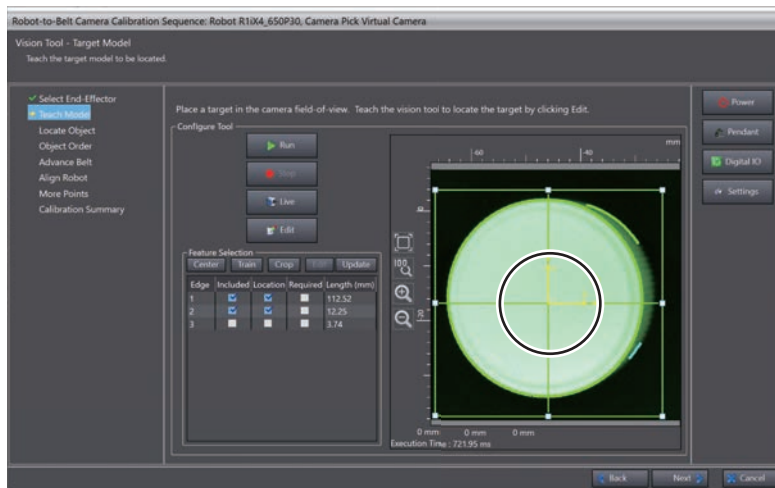

If the detected center point is wrong, drag and drop the arrows of the marker for adjustment.

**12** Click the **Train** button.

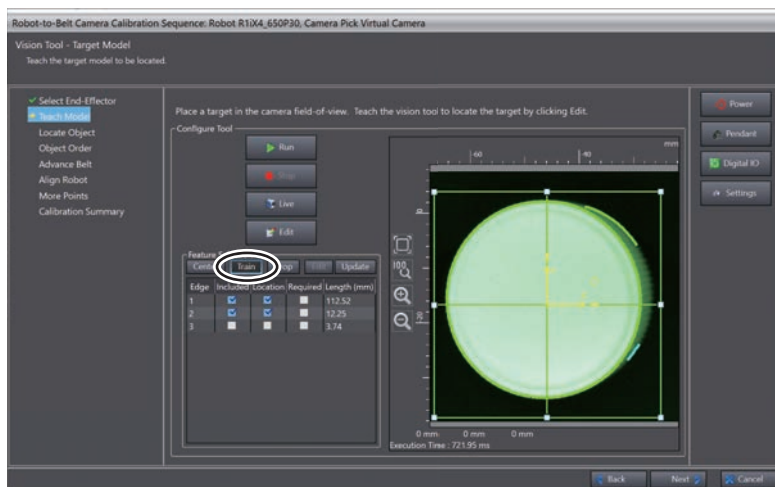

Features are detected.

## 4 Implementation Example of Dynamic Pick-and-place Equipment

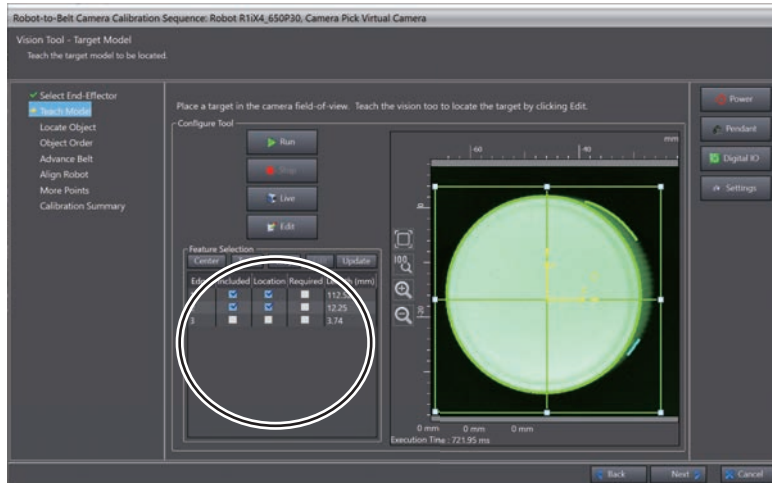

Clear the **Included** check boxes of unnecessary features of the target. The color of edges whose **Included** check boxes have been cleared turn to red from green. After clearing the check boxes, click the **Update** button.

**13** Click the **Next** button.

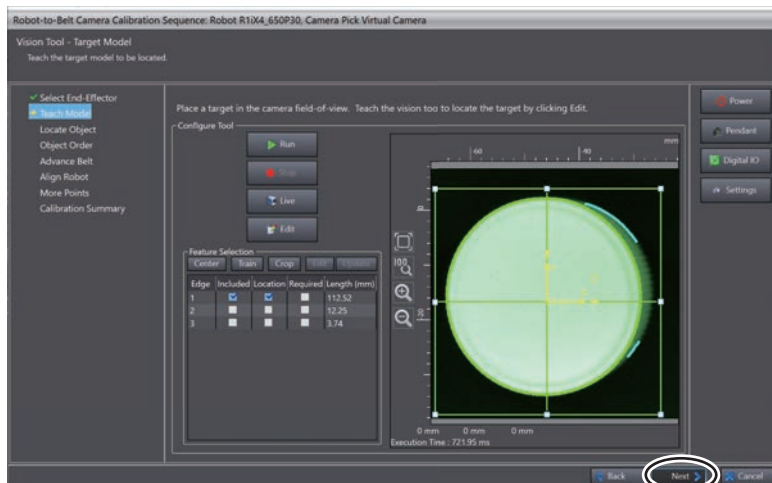

Locations of all targets are detected, and a magenta markers appear around the center of targets.

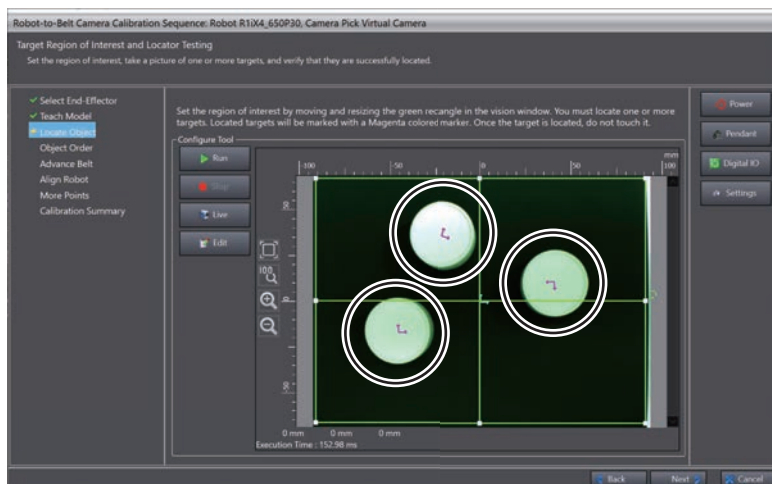

**14** Make sure that the targets have been detected properly, and then click the **Next** button.

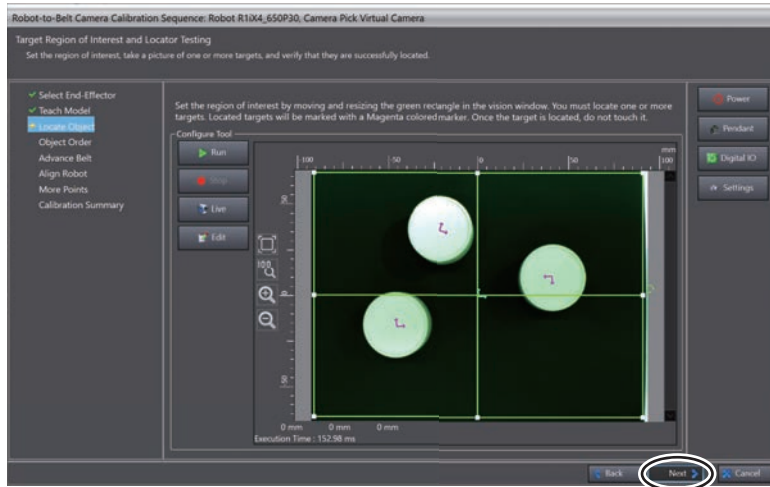

**15** Click the **Next** button in the Target Object Ordering window, which is subsequently displayed.

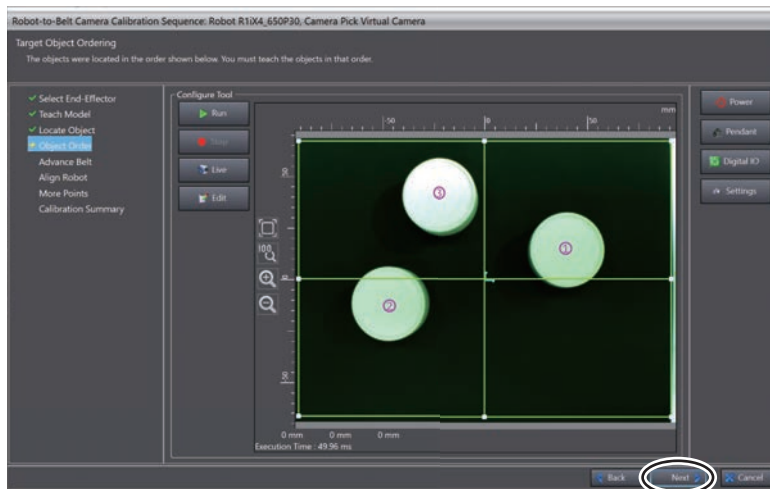

**16** Forward the belt with **On/Off** lamp in the Belt Control pane to move the targets to the point where the robot can reach.

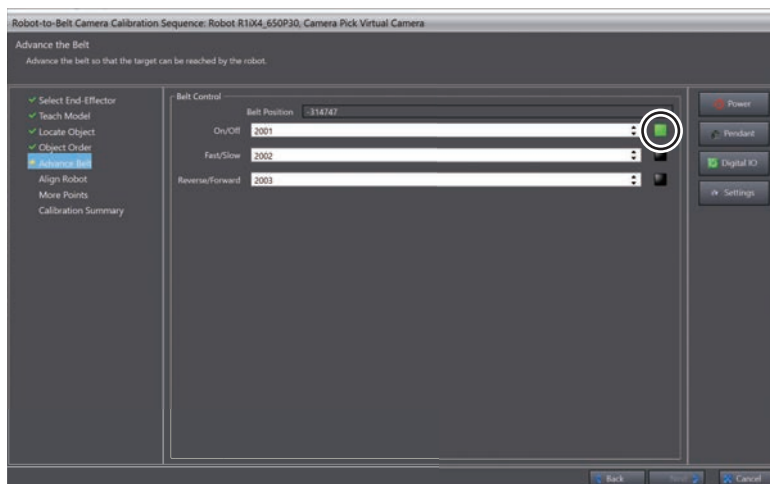

**17** Click the **Next** button.

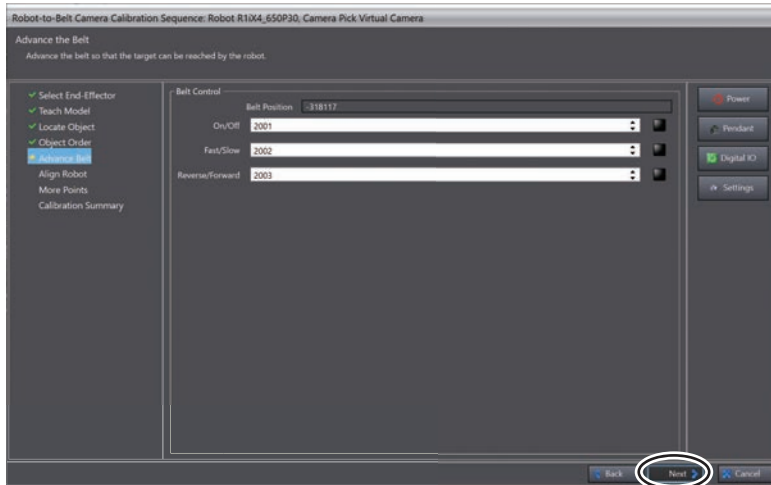

**18** Operate the robot with the T20 Pendant so that its end effector touch the marked target.

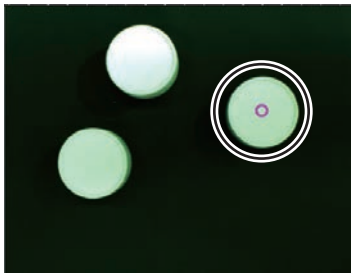

**Additional Information**

It is also possible to move the robot in the **V+ Jog Control** window, which is displayed through a click of the **Pendant** button.

**19** Click the **Here** button.

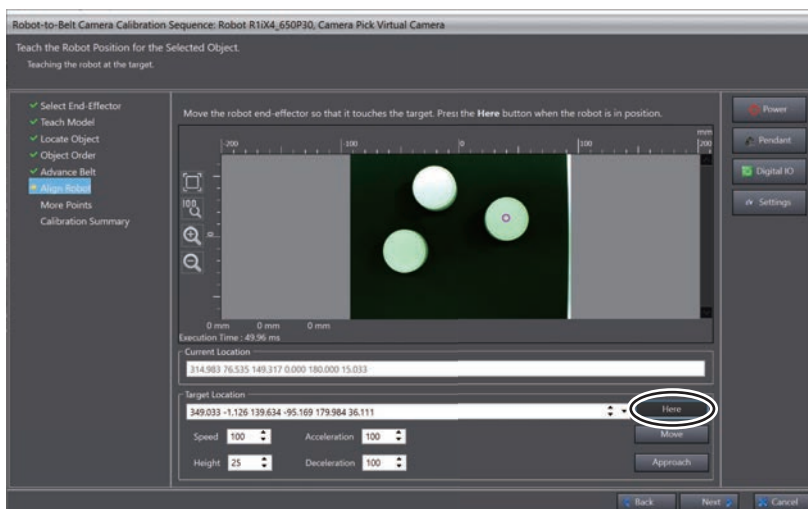

**20** Click the **Next** button.



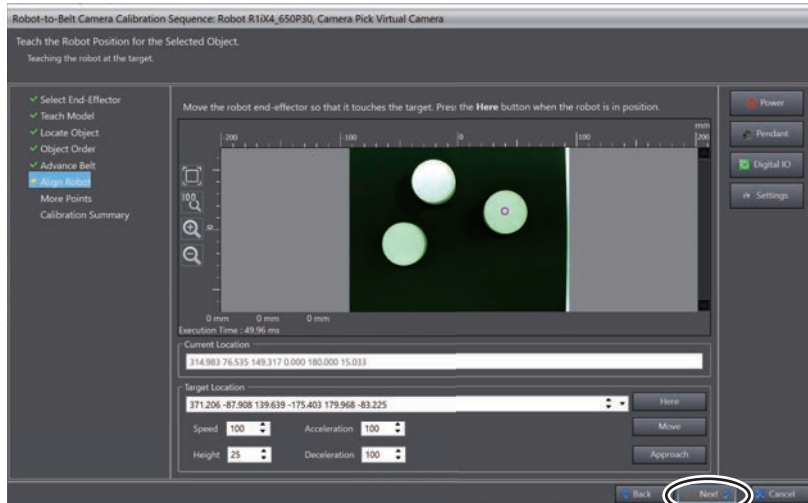

The marker moves to the next target. Repeat the step 19 and 20 for all the target. You need to teach for at least 4 targets. In the example above, three targets were set and taught. So, place the target again in the camera view and perform the step 14 and later.

## 21 Click the **Next** button.

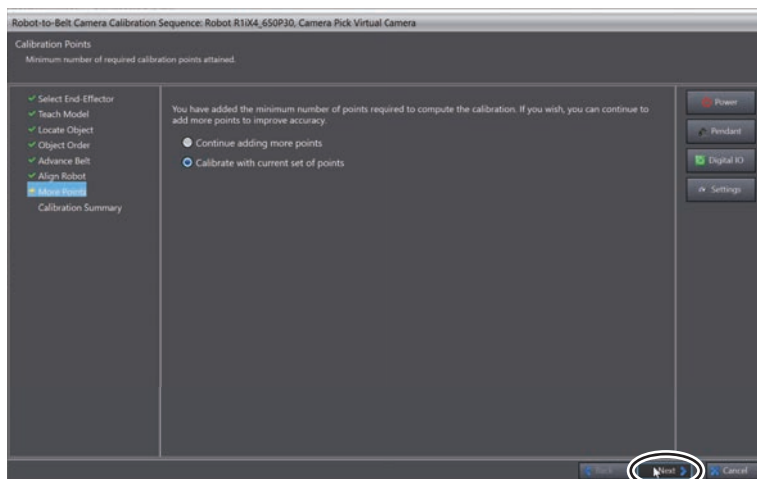

### Additional Information

To increase the accuracy of teaching, select **Continue adding more points** to continue teaching using additional targets.

The Calibration Summary window is displayed.

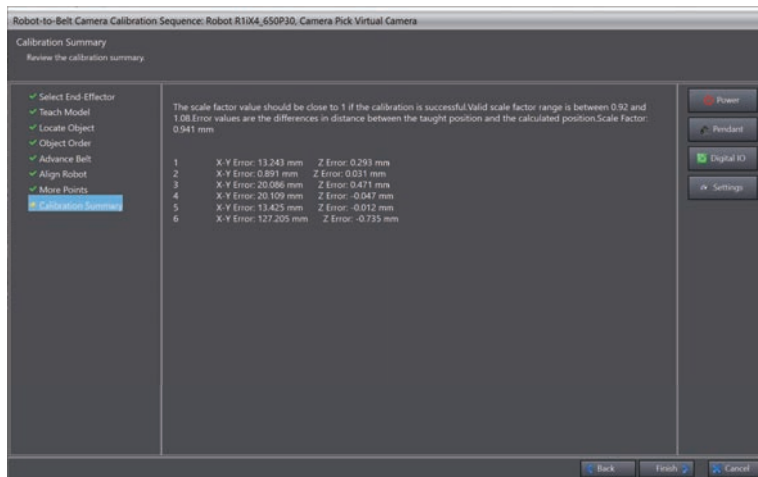

**22** Click the **Finish** button.

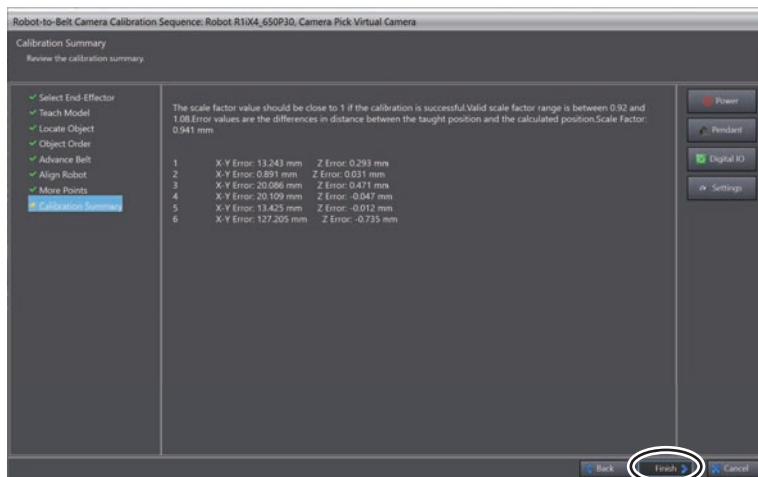

The **Robot-to-Belt Camera Calibration Sequence** dialog is closed.

### 4-5-9 Setting the Locator

Set up the Locator.



#### Additional Information

Refer to the *Automation Control Environment (ACE) Version 4 User's Manual (Cat. No. I633)* for details of the following items.

Item	References in Cat. No. I633
About the configuration items of the locator model (Pick Locator Model in this section) for defining the shape and features of the target	<i>Locator Model Configuration Items in Vision Tools</i>
About the properties of the detected target, which are defined by the locator's configuration items	<i>Locator Configuration Items in Vision Tools</i>

**1** Select **ApplicationManager1** from the device list in Multiview Explorer.



- 2 Double-click **Pick Locator Model** under **Configurations and Setup - Vision Tools** in Multiview Explorer.

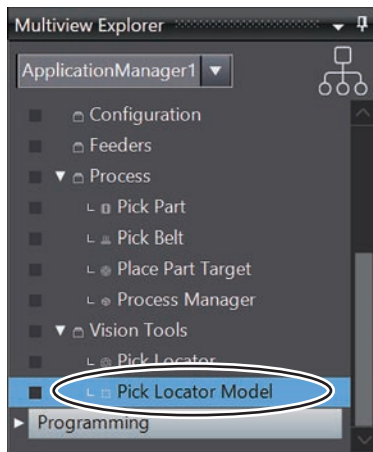

- 3 **Pick Locator Model** tab page is displayed. Click the **Live** button and place the target in the camera view while watching the displayed image. Click the **Stop** button, and then the **New Image** button.

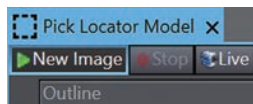

The image is fixed and the green frame appears on the image.

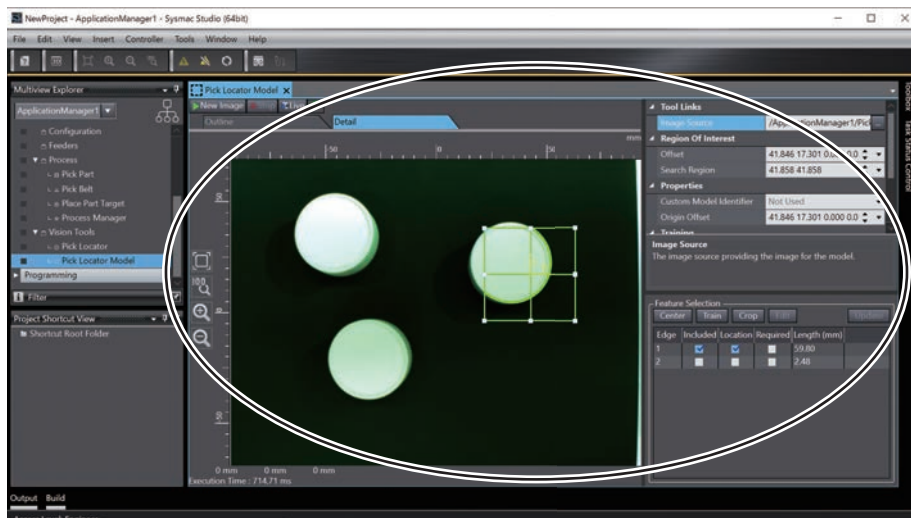

4 Drag and drop the green frame, and scale it to box a target.

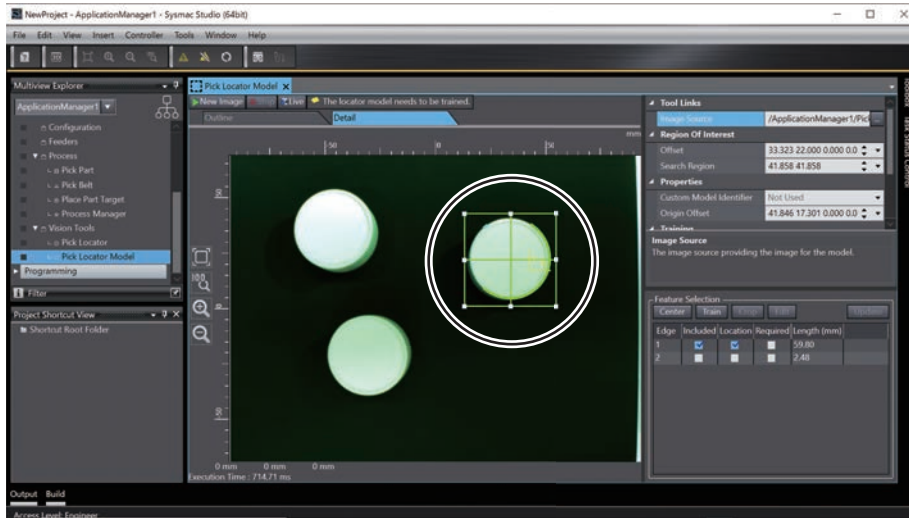

5 Click the **Train** button.

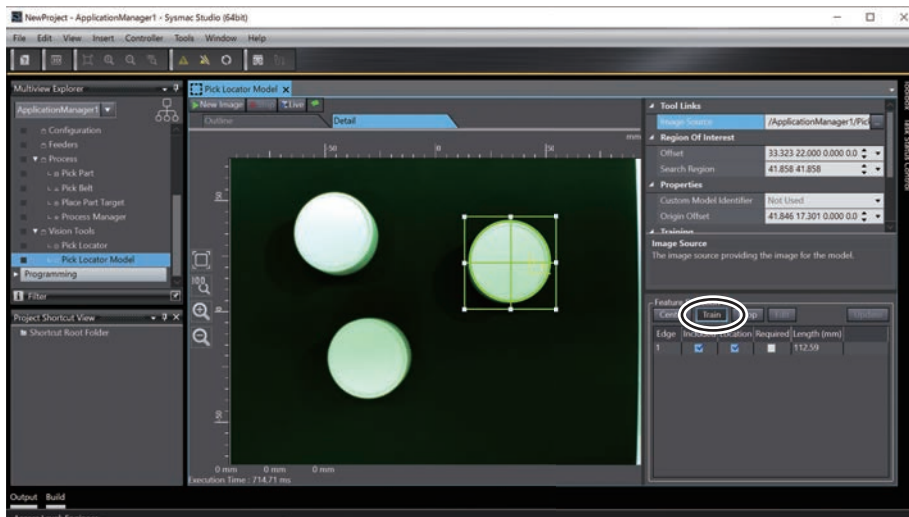

Features of the target are detected and indicated with green lines.

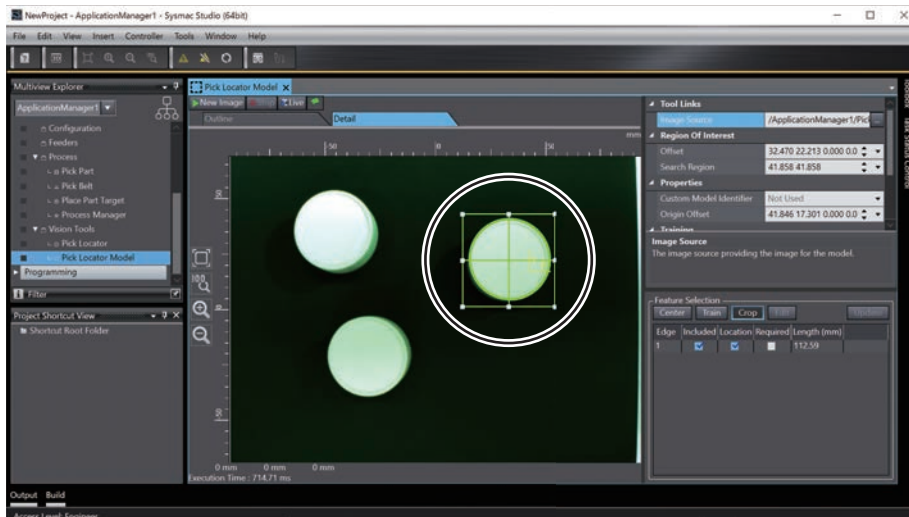

## 6 Click the **Crop** button.

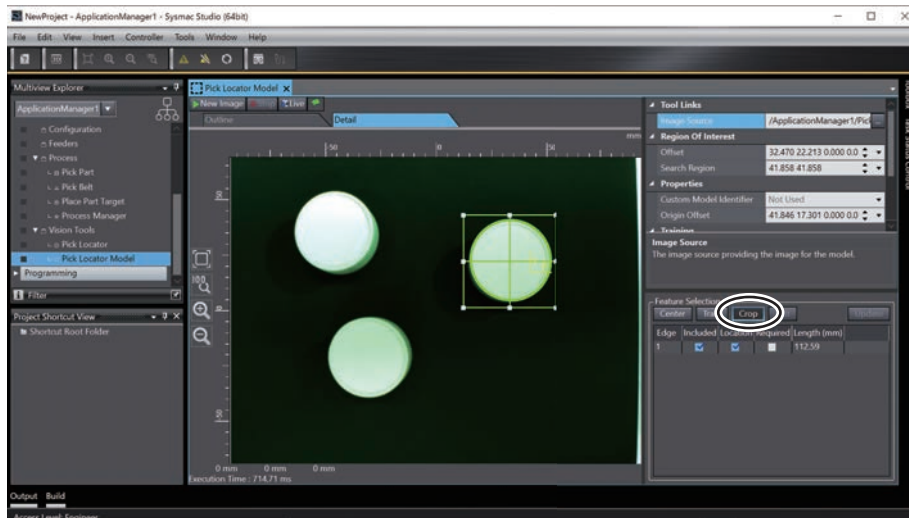

The boxed target is displayed in an enlarged image.

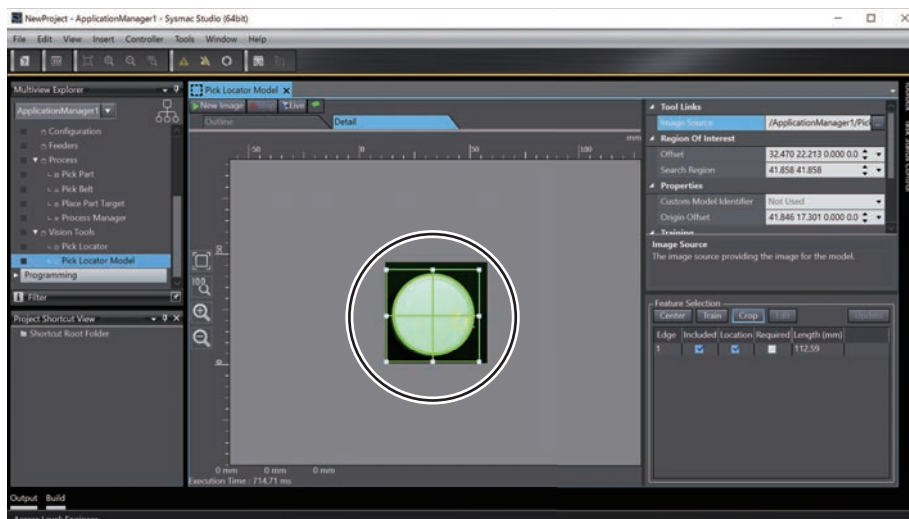

If the detected position and features are not appropriate, adjust them in the way described in *4-5-8 Calibrating the Sensor* on page 4-135.

## 7 Double-click **Pick Locator** under **Configurations and Setup - Vision Tools** in Multiview Explorer.

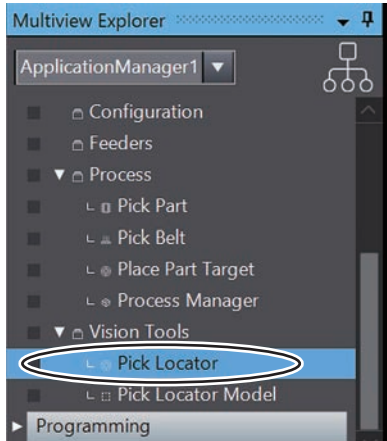

The model you have created is registered to the **Models** pane.

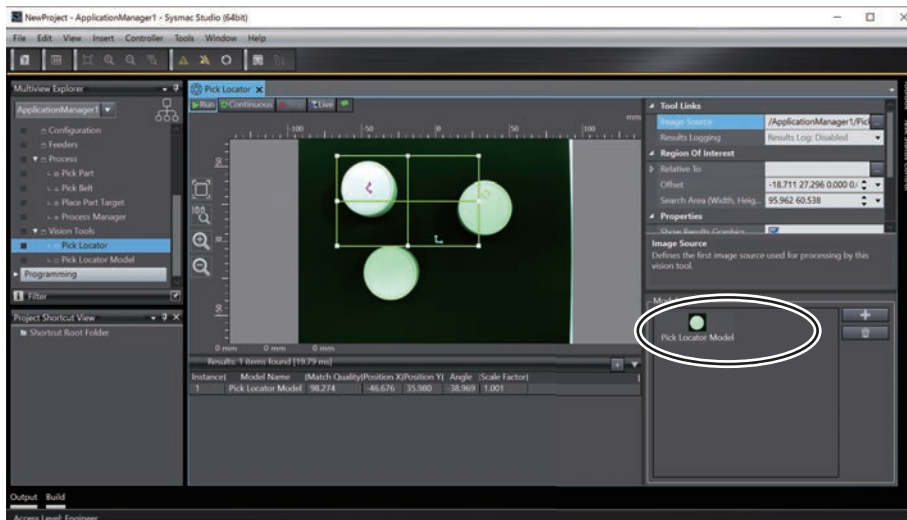

A target in the green frame is detected in the **Pick Locator** tab page, and a magenta marker appears around the center of the detected target.

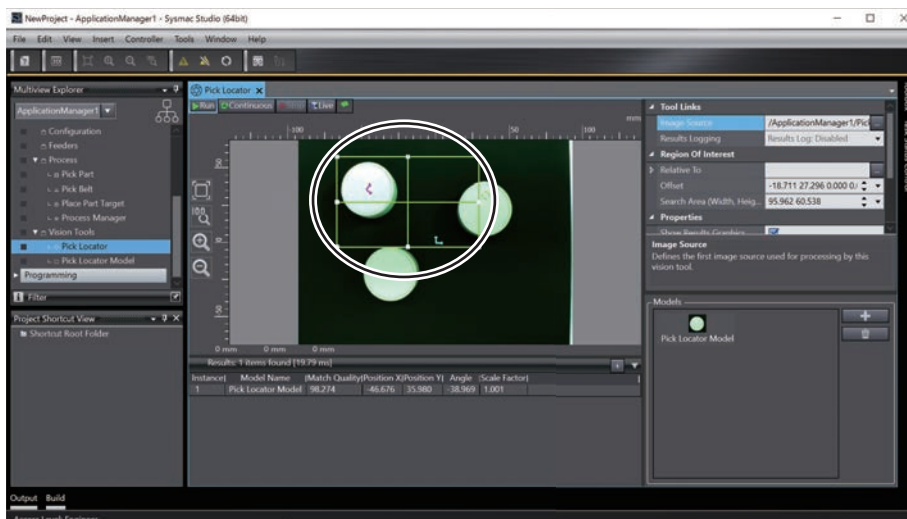

**8** Drag and drop the green frame, and expand it to an entire shooting range.

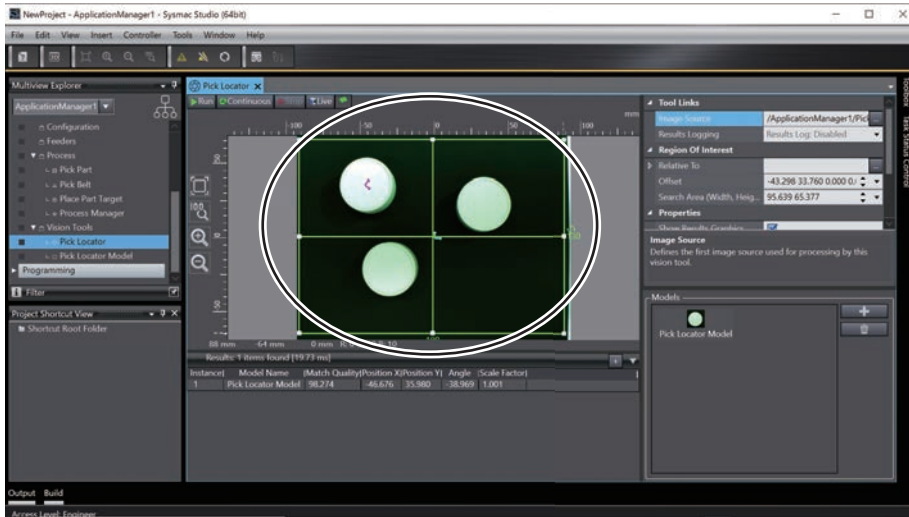

Locations of all the target in the green frame are recognized.

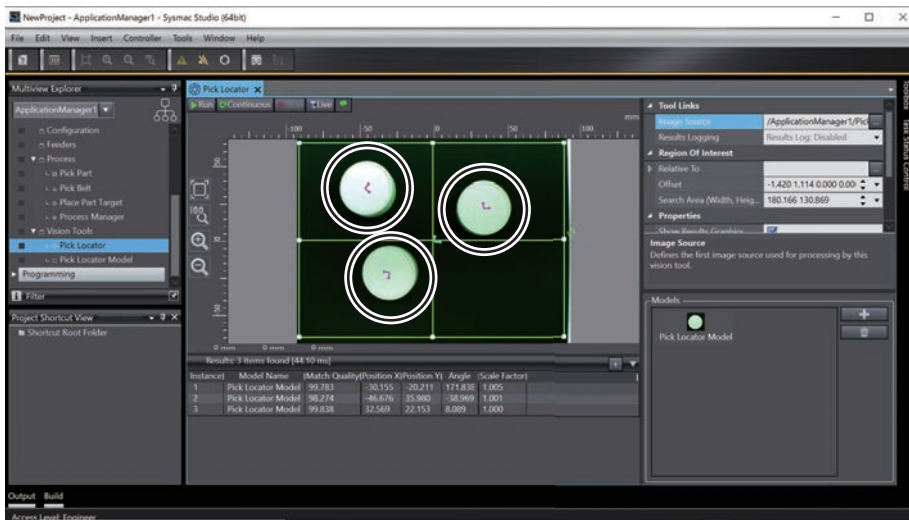

### 4-5-10 Teaching Idle, Pick, and Place Positions

- 1 Select **ApplicationManager1** from the device list in Multiview Explorer.

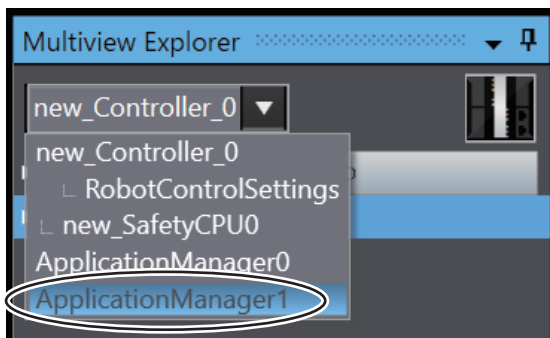

- 2 Double-click **Process Manager** under **Configurations and Setup - Process**.

## 4 Implementation Example of Dynamic Pick-and-place Equipment

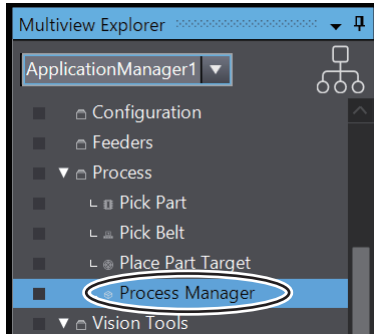

The **Process Manager** tab page is displayed.

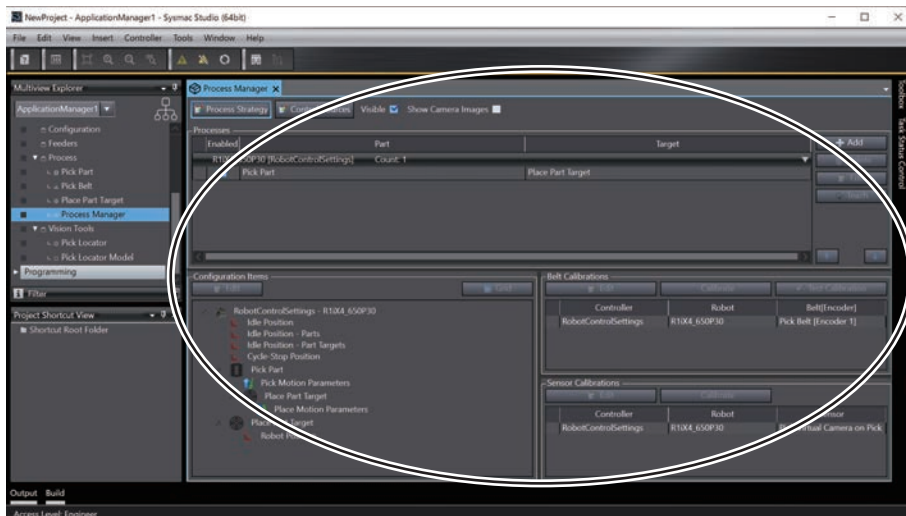

**3** Select a process from the **Processes** list.

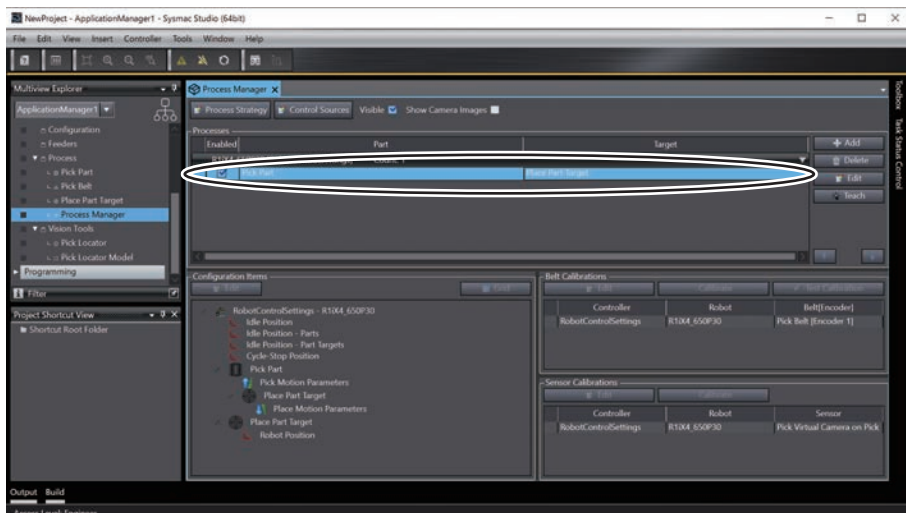

1) Click the **Teach** button at the right of the list.



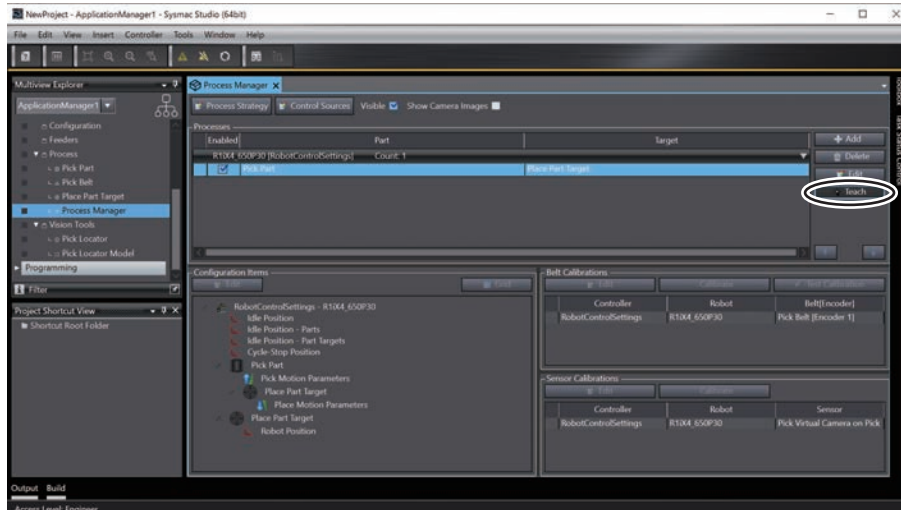

The **Teaching a Process** dialog box is displayed.

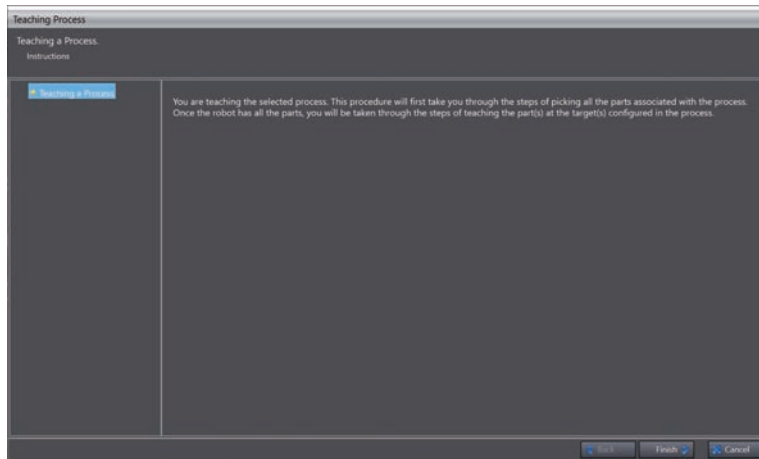

**4** Click the **Finish** button.

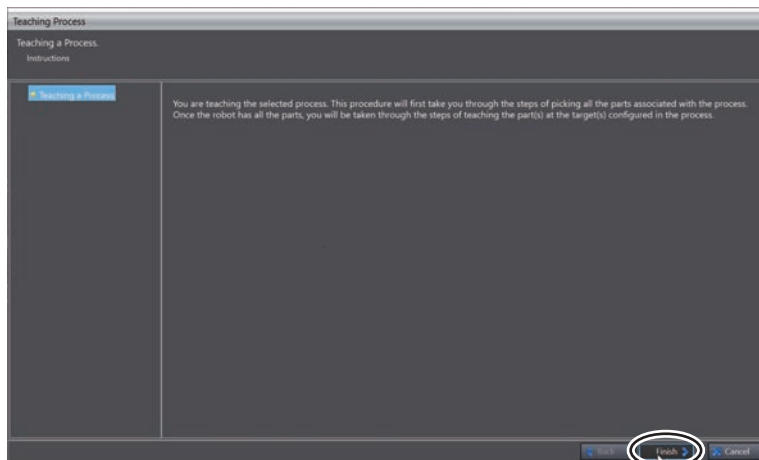

The teaching window appears.

**5** Adjust each teaching following instructions shown in the window. Adjustment can be performed in the same way as simulation.

Use the T20 Pendant to move the robot. Clicking the **Pendant** button enables to move the robot on the **V+ Jog Control** window.

In the **Locate Object** window, you can confirm it is possible to detect a location of a target placed alone.

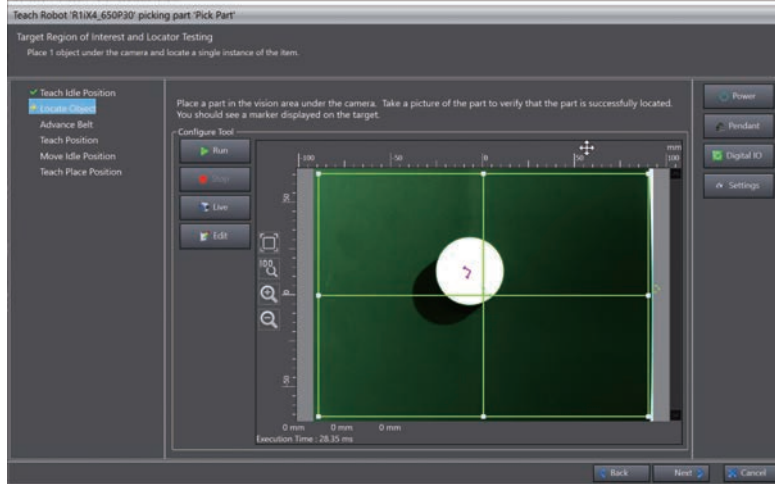

### 4-5-11 Running the Program to Check the Operation

Check that turning on the Robot Integrated CPU Unit and IPC Application Controller runs the program automatically.

- 1 Select **RobotControllerSettings** from the device list in the Multiview Explorer.

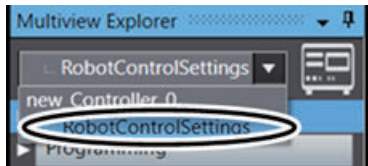

- 2 Click **Controller - Offline** from the menu bar.
- 3 On the V+ program supervisor, rewrite the IP address assigned to  $\$ip$  to that of the IPC Application Controller.

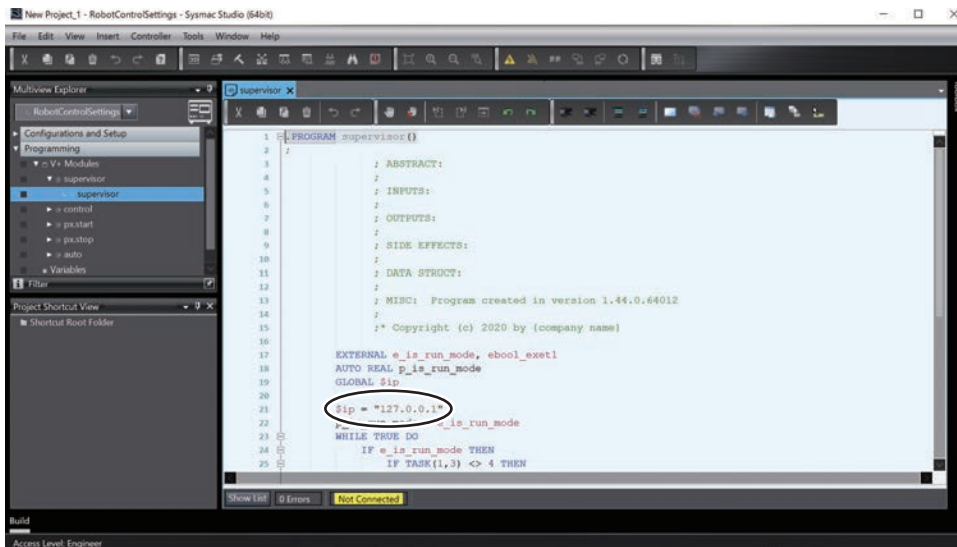

In case the IPC Application Controller IP address is 192.168.250.201, rewrite it as illustrated in the screen shot below.

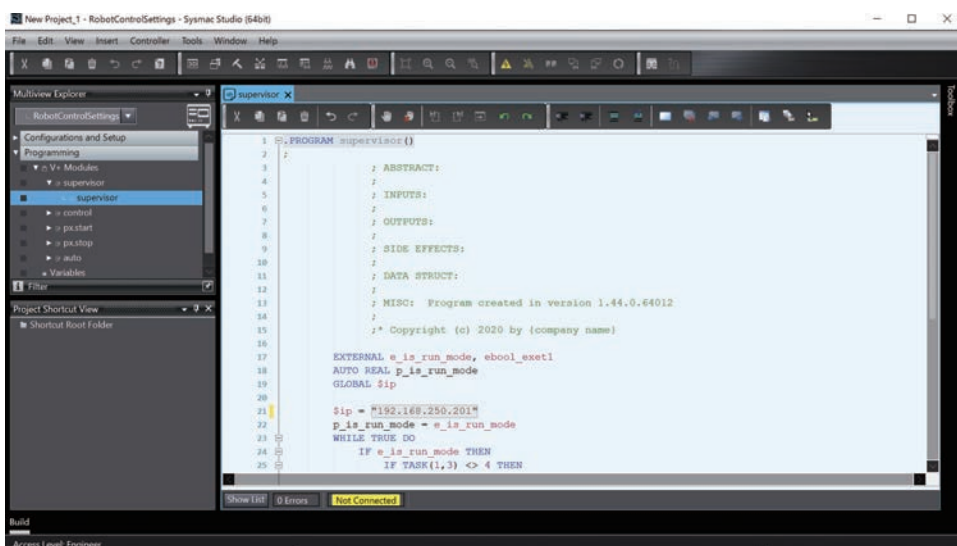

- 4 Click **Controller - Online** from the menu bar. Sysmac Studio goes online.
- 5 Click the synchronization icon in the toolbar.

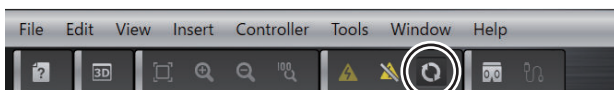

The **Synchronization** window is displayed.

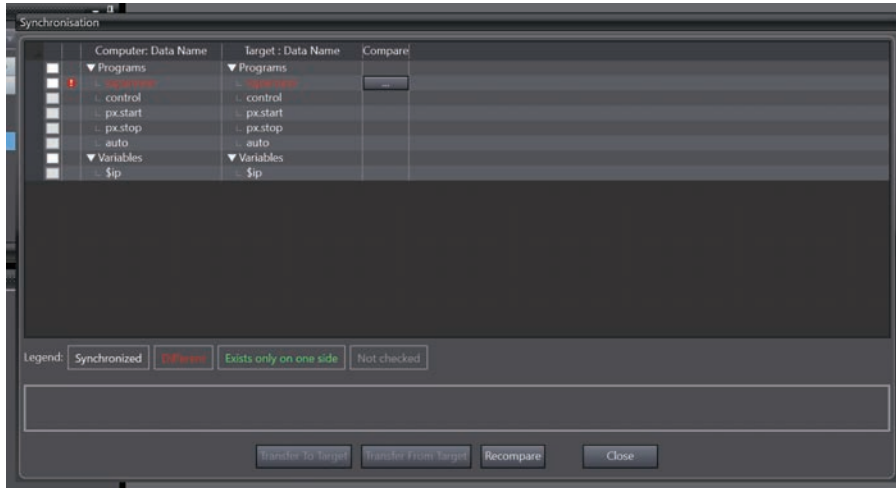

6 Check the **supervisor** box under **Programs**.

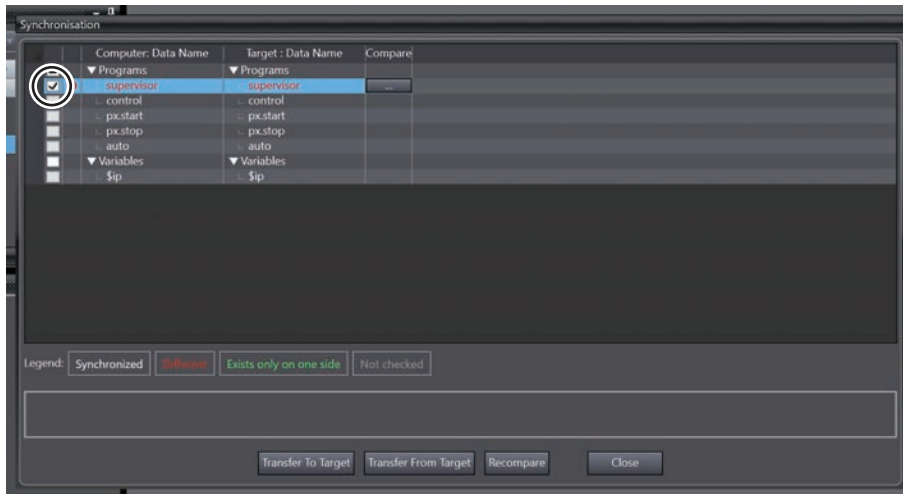

7 Click the **Transfer To Target** button.

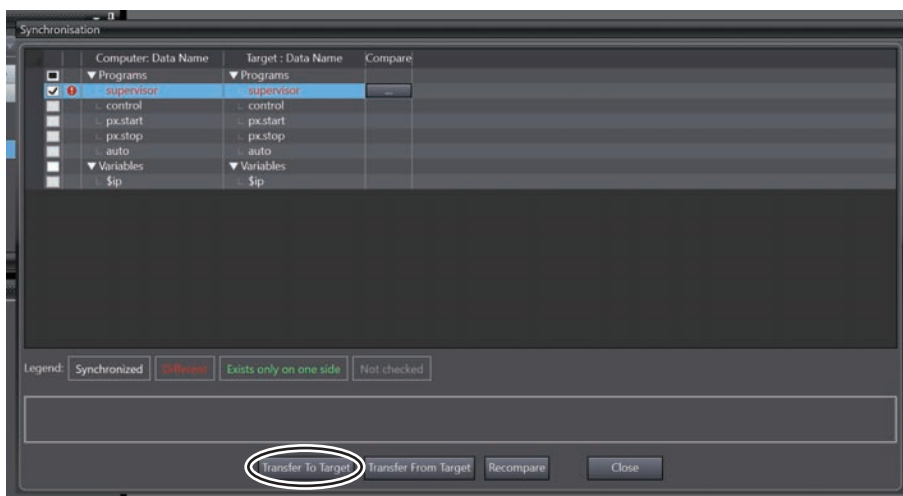

The supervisor program is transferred to the Robot Integrated CPU Unit.

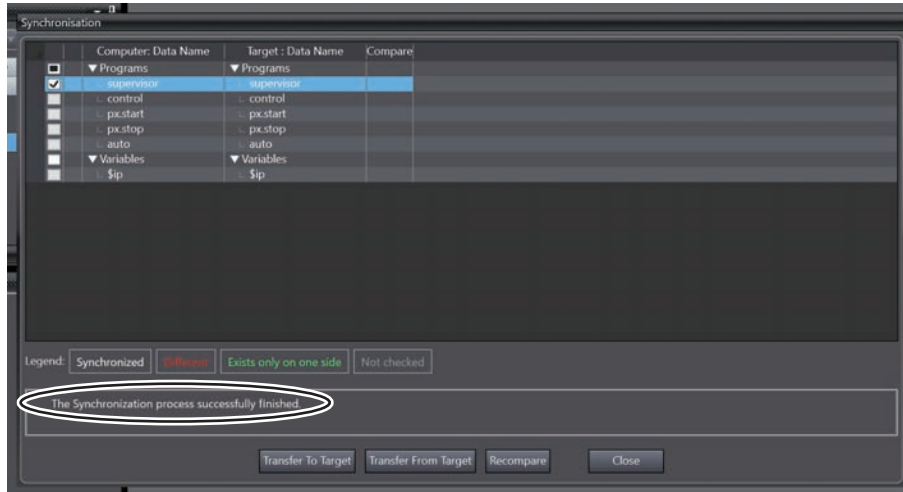

**8** Click the **Close** button.  
The **Synchronisation** window is closed.

**9** Select **ApplicationManager1** from the device list in Multiview Explorer.

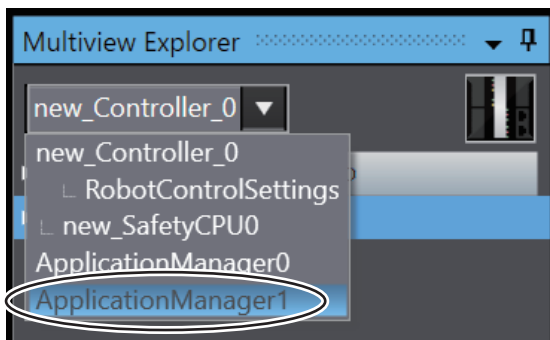

**10** Click **Configurations and Setup - Configuration - Add - Controller Connection Startup**.

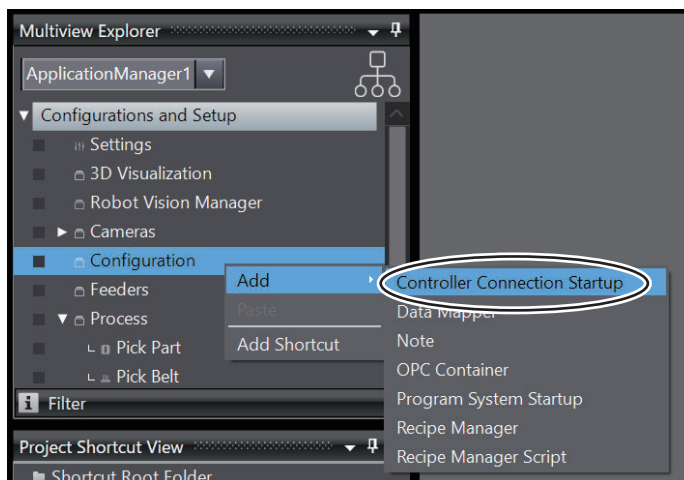

**Controller Connection Startup0** is added under **Configuration**.

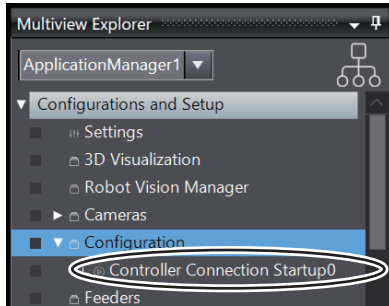

**11** Double-click **Controller Connection Startup0**.

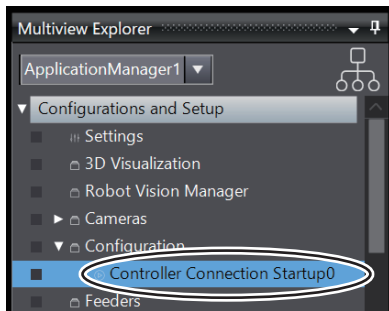

**Controller Connection Startup0** tab page is displayed.

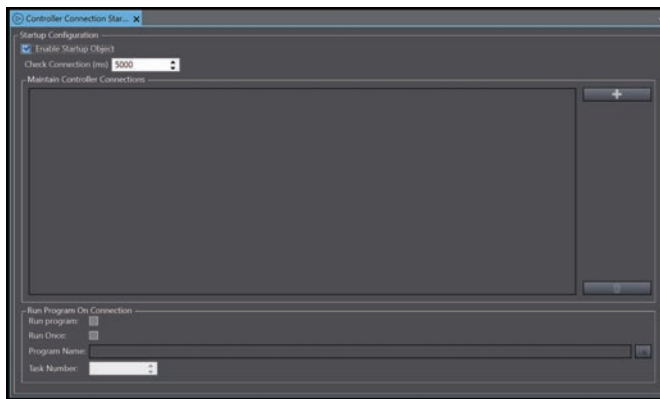

**12** Click the + button.

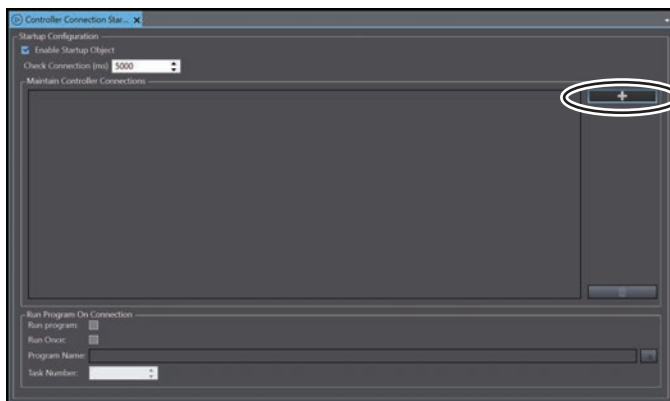

The **Select a Reference** dialog appears.

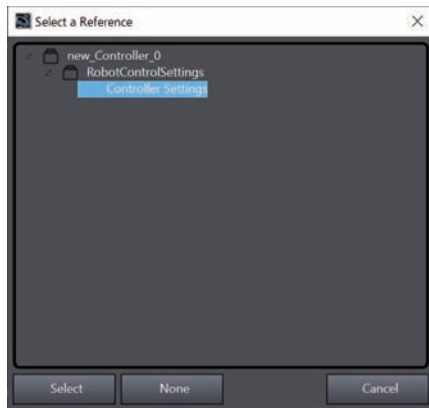

**13** Select **Controller Settings**, then click the **Select** button.

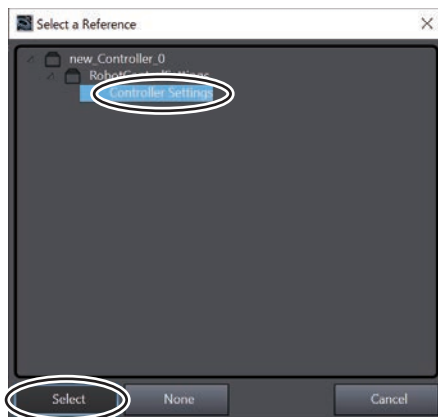

`/new_Controller_0/Controller Settings` is added to the **Controller Connection Startup0** tab page.

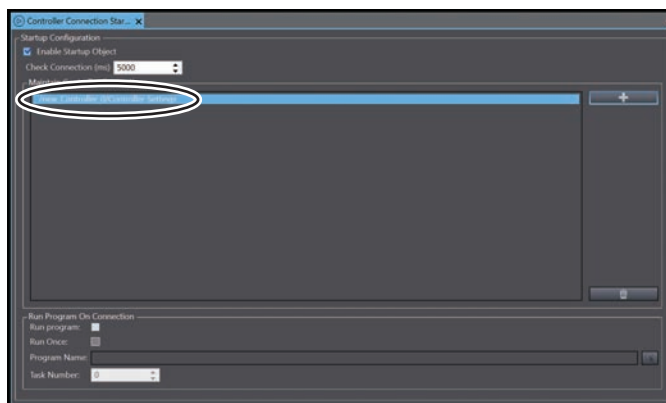

**14** Click the synchronization icon in the toolbar.

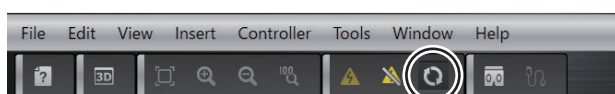

The **Synchronization** window is displayed.

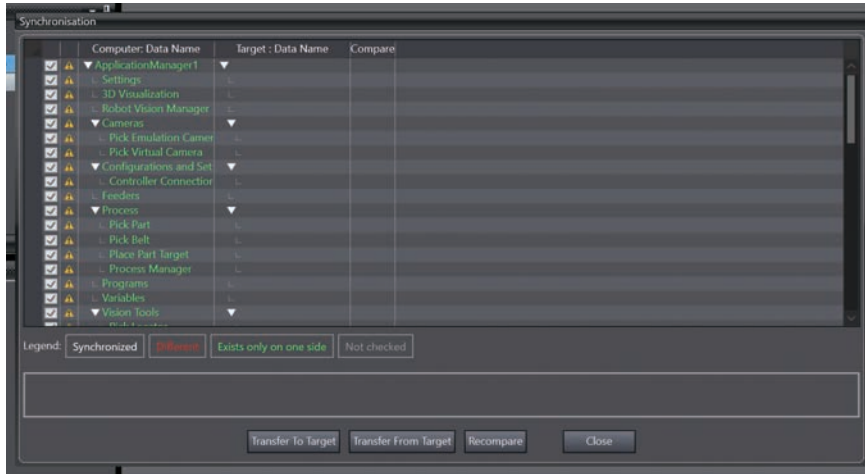

**15** Click the **Transfer To Target** button.

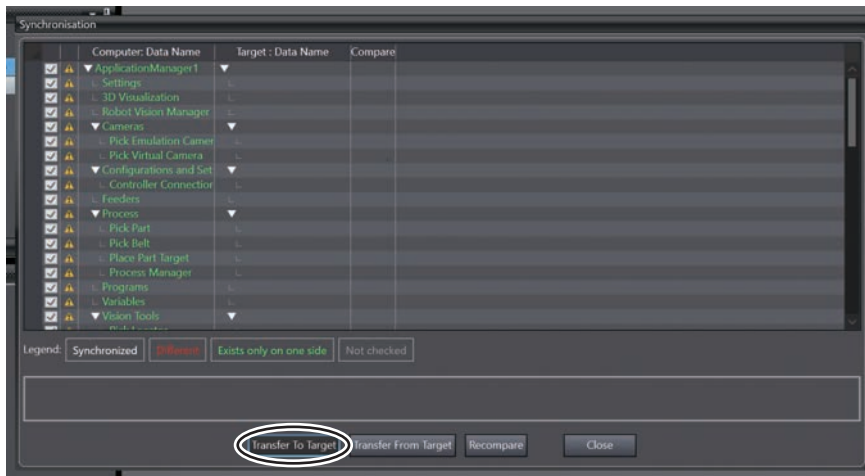

The settings and program is transferred to the destination IPC Application Controller.

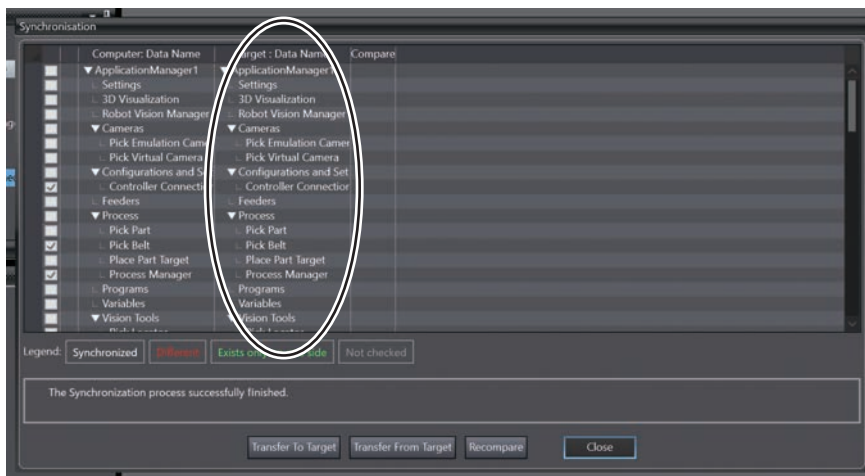

**16** Click the **Close** button.



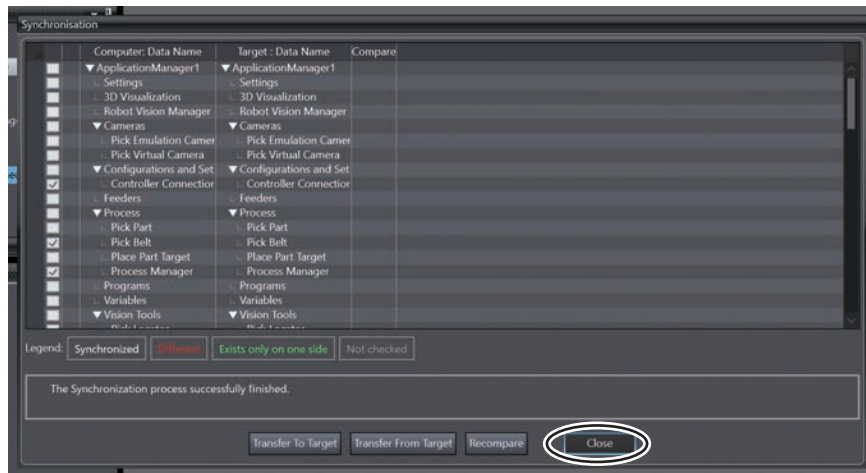

The **Synchronization** window is closed.

- 17** Disconnect Sysmac Studio (offline) to the Robot Integrated CPU Unit and IPC Application Controller.

To go offline, select **Offline** instead of **Online** in the processes described in *Connecting Sysmac Studio to the Robot Integrated CPU Unit Online* on page 4-110 and *Going Online with the IPC Application Controller* on page 4-111.

- 18** Power off the Robot Integrated CPU Unit and IPC Application Controller.

- 19** Power on the Robot Integrated CPU Unit and IPC Application Controller.

- 20** Boot up ACE as a server in the IPC Application Controller.

Refer to Automation Control Environment (ACE) Version 4 User's Manual (Cat. No. I633) for the ACE server instance.

- 21** Establish an online connection between Sysmac Studio and the Robot Integrated CPU Unit.  
Refer to *Connecting Sysmac Studio to the Robot Integrated CPU Unit Online* on page 4-110 for the procedure to connect online.

- 22** Set TRUE to *gStart* in the **Watch (Project)1** tab page.

Device name	Name	Online value	Modify	Comment
new_Controller_0	lgStart	False	TRUE FALSE	Auto start Button
new_Controller_0	Input Name...			

Refer to *4-5-5 Running a Sequence Control Program and V+ Program* on page 4-126 for how to open the Watch tab page.

- 23** Turn on the robot high power on the robot front panel.

1) Switch the front panel to Auto mode.

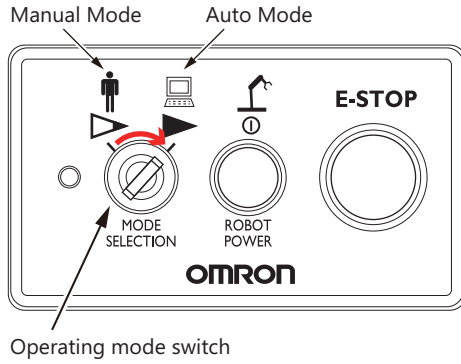

2) Press the Robot Power button.  
The Robot Power button blinks.

3) Press the Robot Power button again.

The robot high power turns ON, then the dynamic pick-and place program runs automatically.  
The carrying conveyor A operates.

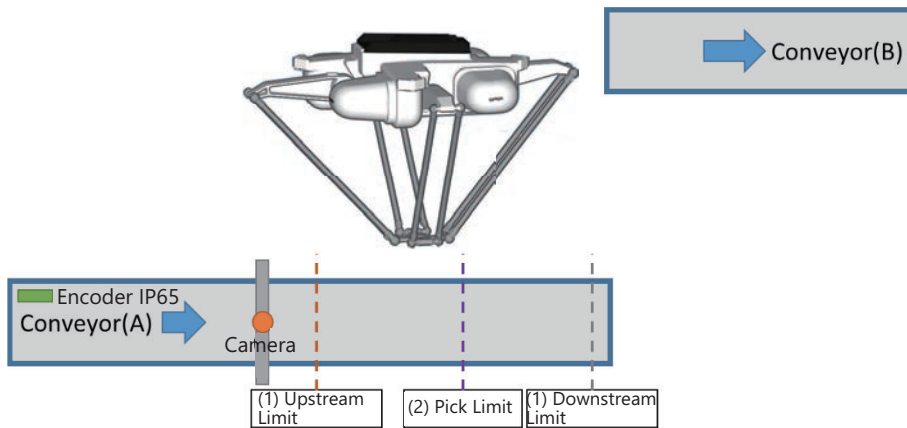

**24** Put a part at the upstream of the conveyor A.

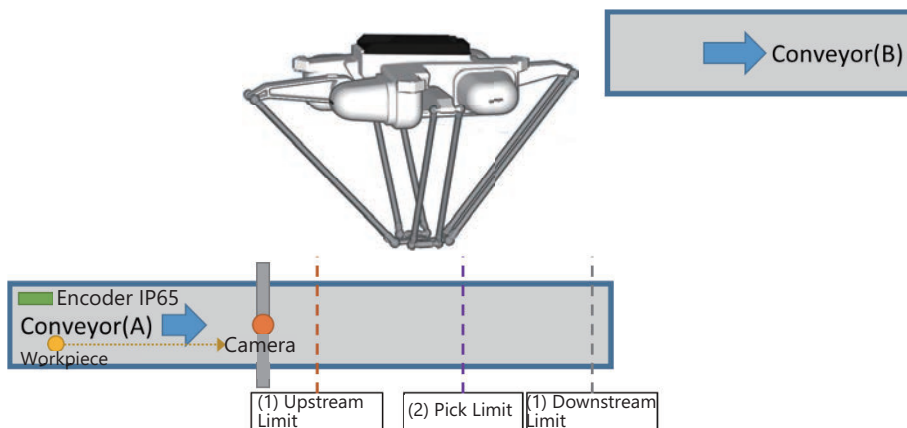

**25** Check that the robot works as described in the following.

1) The robot moves to the upstream limit point when the camera detects the part, then pause.

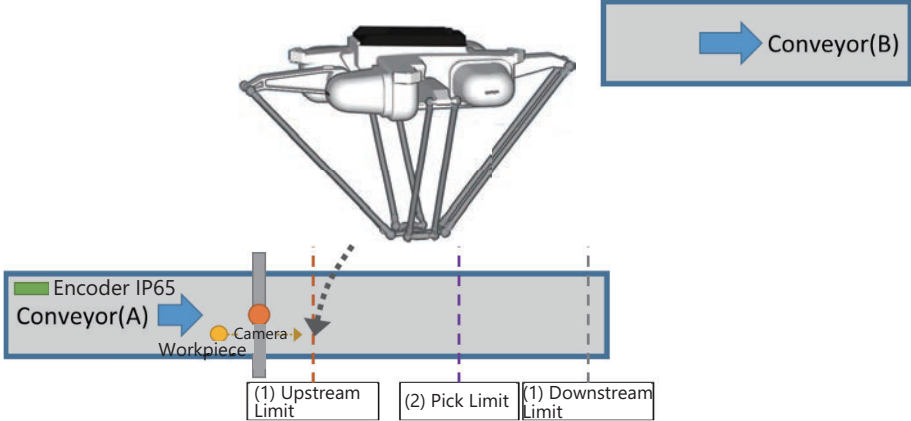

2) The part is carried to the upstream limit point, then the robot picks up the part and place it on the conveyor B.

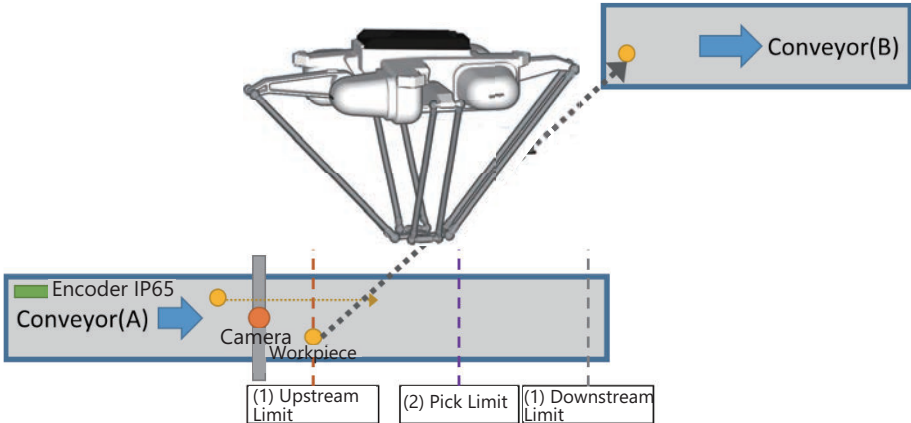

**26** Repeat Step 24 to 25 to check the robot works as described in the following. The robot repeats picking and placing the parts detected subsequently.

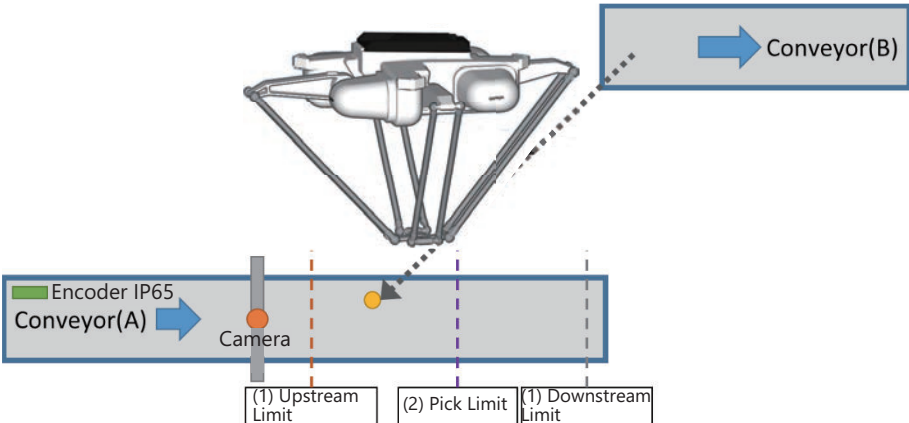





# Appendices

---

---

<b>A-1</b>	<b>Designing Example of the Safety Functions for the Pick-and-place Equipment.....</b>	<b>A-2</b>
A-1-1	Pick-and-place Equipment Configuration .....	A-2
A-1-2	Hazards .....	A-4
A-1-3	Protective Measure .....	A-4
A-1-4	Safety Functions.....	A-4
A-1-5	Safety System Configuration and Devices .....	A-5
A-1-6	Installation and Wiring .....	A-7
A-1-7	Settings and Programming.....	A-13
<b>A-2</b>	<b>How to Use 3D Visualizer .....</b>	<b>A-21</b>
A-2-1	Set the 3D Visualizer to the Float Mode .....	A-21
A-2-2	Rotate the Viewpoint .....	A-23
A-2-3	Translate the Viewpoint .....	A-25
A-2-4	Zoom-in and Zoom-out.....	A-26
<b>A-3</b>	<b>Setting Items on the Sysmac Studio and the Setting Targets .....</b>	<b>A-28</b>
<b>A-4</b>	<b>Using Troubleshooting Functions .....</b>	<b>A-29</b>



# A-1 Designing Example of the Safety Functions for the Pick-and-place Equipment

---

This section describes the designing example of the safety functions for the pick-and-place equipment.



## Precautions for Correct Use

---

You must implement the actual safety measures based on the *Robot Safety Guide (Cat. No. 1590)* and risk assessment. In addition, it is necessary to consider the performance level and safety distances of the equipment while it conforms to the safety standards.

---

### A-1-1 Pick-and-place Equipment Configuration

The configuration of the pick-and-place equipment inclusive of the safety devices is shown in the table below.

**A**

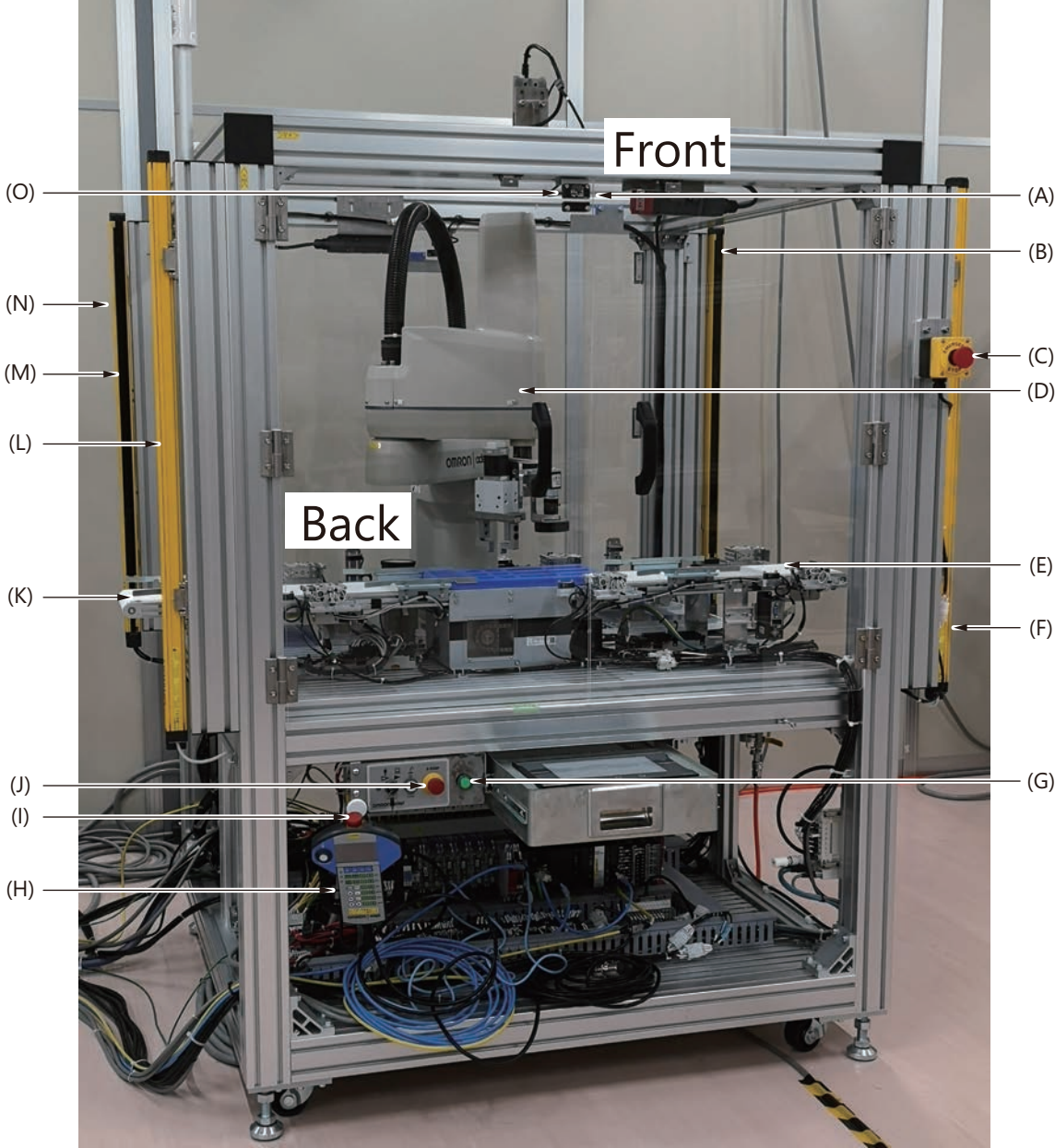

Letter	Name
A	Safety door switch 2
B	Safety light curtain 2 (Emitter)
C	Emergency stop pushbutton switch 1
D	Robot
E	Belt conveyor (Unload side)
F	Safety light curtain 2 (Receiver)
G	Reset switch
H	Enable switch on T20 pendant
I	E-STOP button on T20 pendant
J	E-STOP button on front panel
K	Belt conveyor (Load side)
L	Safety light curtain 1 (Receiver)
M	Safety light curtain 1 (Emitter)
N	Emergency stop pushbutton switch 2
O	Safety door switch 1

### A-1-2 Hazards

The movable parts of the robot are the mechanical hazards in the system configuration described in this section.

### A-1-3 Protective Measure

You must assume the cases in which the hazards are approached from each side of the pick-and-place equipment.

The safeguarding to each case is implemented as shown in the table below.

Equipment side	Approached case	Safeguarding	Safety device
Back	---	Fixed guard	---
Front	Adjustment/ maintenance	Movable guard	Safety door switch
Loading side	Loading	Opto-electronic protective device	Safety light curtain
Unload side	Unloading	Opto-electronic protective device	Safety light curtain

In addition to the safeguarding, the emergency stop switches as the complementary protective measures are placed at positions accessible from each side of the equipment.

Equipment side	Complementary protective measure	Safety device
Back	Emergency stop switch	Emergency stop pushbutton switch
Front		Emergency stop pushbutton switch
		E-STOP button on T20 pendant
		E-STOP button on front panel

### A-1-4 Safety Functions

You must decide the safety function of each safety device for the case it operated.

The functions need to be decided for each operating mode of the OMRON robot.



## Auto Mode

Set the safety functions when the operating mode of the OMRON robot is in Auto mode as shown in the table below.

Safety device	Safety function	Recovery
Emergency stop pushbutton switch 1	Stop the robot when pressed	High power ON after resetting
Emergency stop pushbutton switch 2	Stop the robot when pressed	High power ON after resetting
Safety light curtain 1	Stop the robot when the beam is interrupted	High power ON
Safety light curtain 2	Stop the robot when beam is interrupted	High power ON
Safety door switch 1	Stop the robot when the door is open	High power ON after resetting
Safety door switch 2	Stop the robot when the door is open	High power ON after resetting
E-STOP button on front panel	Stop the robot when pressed	High power ON after resetting
E-STOP button on T20 pendant	Stop the robot when pressed	High power ON after resetting
Enable switch on T20 pendant	---	---

## Manual Mode

Set the safety functions when the operating mode of the OMRON robot is in Manual mode as shown in the table below.

Safety device	Safety function	Recovery
Emergency stop pushbutton switch 1	Stop the robot when pressed	Reset
Emergency stop pushbutton switch 2	Stop the robot when pressed	Reset
Safety light curtain 1	---	---
Safety light curtain 2	---	---
Safety door switch 1	---	---
Safety door switch 2	---	---
E-STOP button on front panel	Stop the robot when pressed	Reset
E-STOP button on T20 pendant	Stop the robot when pressed	Reset
Enable switch on T20 pendant	Stop the robot when not pressed or fully pressed passing the middle position	High power ON

### A-1-5 Safety System Configuration and Devices

You must select the safety system configuration and devices for it to achieve the safety functions.

## Safety System Configuration

The safety system configuration in this guide uses an NX-series EtherNet/IP Coupler Unit and NX-series Safety Control Units.

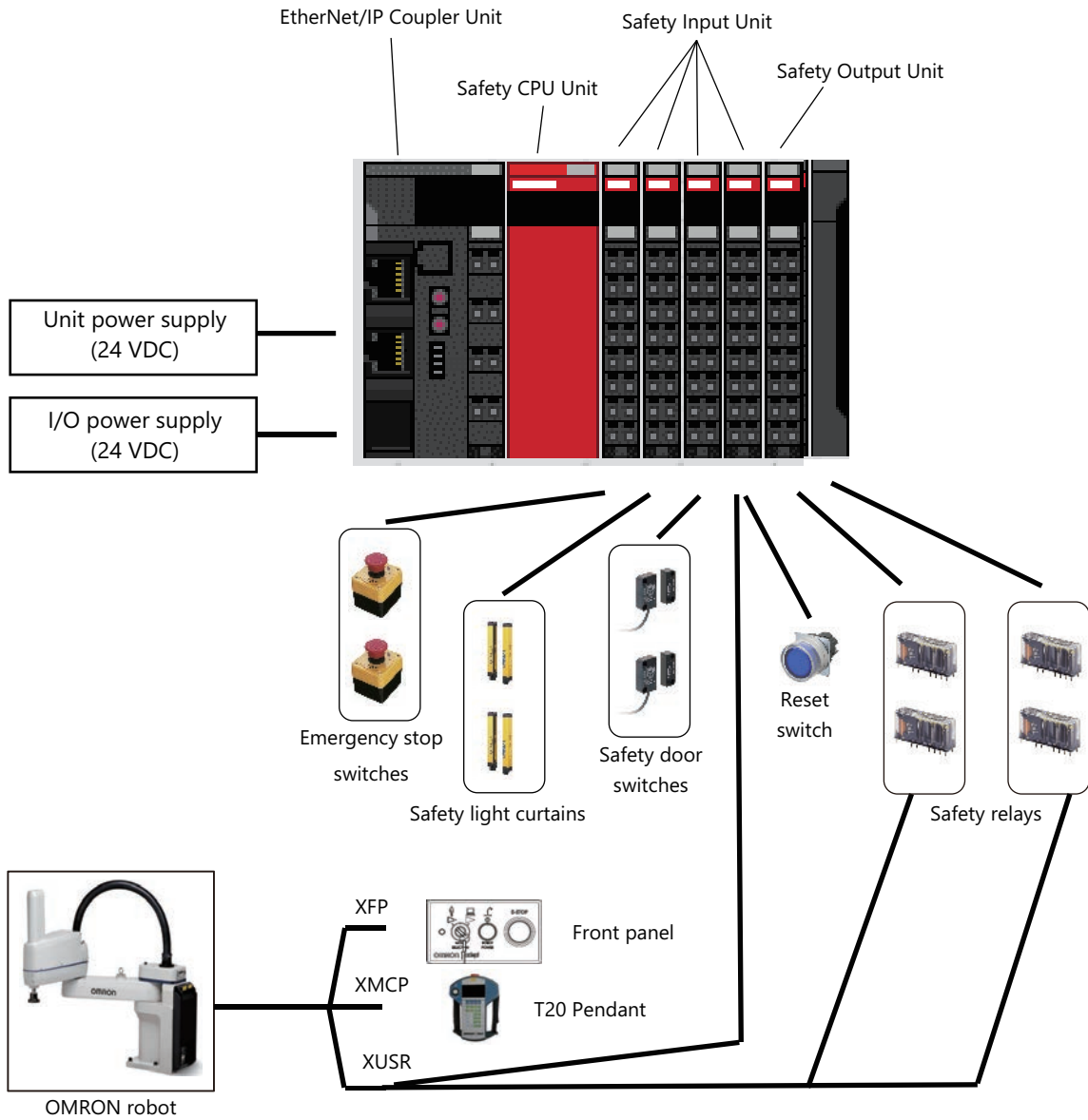

## Configuration Devices

The safety system configuration in this guide uses the devices shown in the table below.

Name	Model	Manufacturer	Description
EtherNet/IP Coupler Unit	NX-EIC202	OMRON	A Coupler Unit that supports EtherNet/IP. This Unit can compose a Slave Terminal by connecting with an NX Unit.
Safety CPU Unit	NX-SL3300	OMRON	A Unit that runs safety programs.
Safety Input Unit	NX-SIH400	OMRON	A Unit to be connected with safety input devices.
Safety Output Unit	NX-SOD400	OMRON	A Unit to be connected with safety output devices.
Safety Light Curtain	F3SG	OMRON	A photoelectric safety sensor. This sensor detects human entry to hazardous area.
Safety Door Switch	D40A	OMRON	A non-contact safety door switch. This switch detects open and close of the entrance door to hazardous area.
Reset Switch	A22-H □-10M	OMRON	A reset switch. This switch is used to manually recover the equipment from the stop state after the safety function operated.
Emergency Stop Pushbutton Switch	A22E	OMRON	An emergency stop switch.
Safety Relay	G7SA	OMRON	A safety relay.
Unit Power Supply	S8VK	OMRON	A 24 VDC power supply. This control power supply is for the EtherNet/IP Coupler Units and the NX Units.
I/O Power Supply	S8VK	OMRON	A 24 VDC power supply. This power supply is for the I/O circuits of the NX Units and the connected external devices.

## A-1-6 Installation and Wiring

This section describes the installation and wiring related to the safety functions for the pick-and-place equipment.

The NX Unit configuration of the EtherNet/IP Slave Terminal and the wiring diagram of the safety devices are described in this guide.

Refer to the following manual for details on installing and wiring the actual devices.

- NX-series Safety Control Unit User's Manual (Cat. No. Z930)
- NX-series EtherNet/IP Coupler Unit User's Manual (Cat. No. W536)
- eCobra 600 and 800 Robot with EtherCAT User's Guide (Cat. No. I653)
- T20 Pendant User's Guide (Cat. No. I601)

### NX Unit Configuration

Compose the EtherNet/IP Slave Terminal by the connection order shown in the figure below.

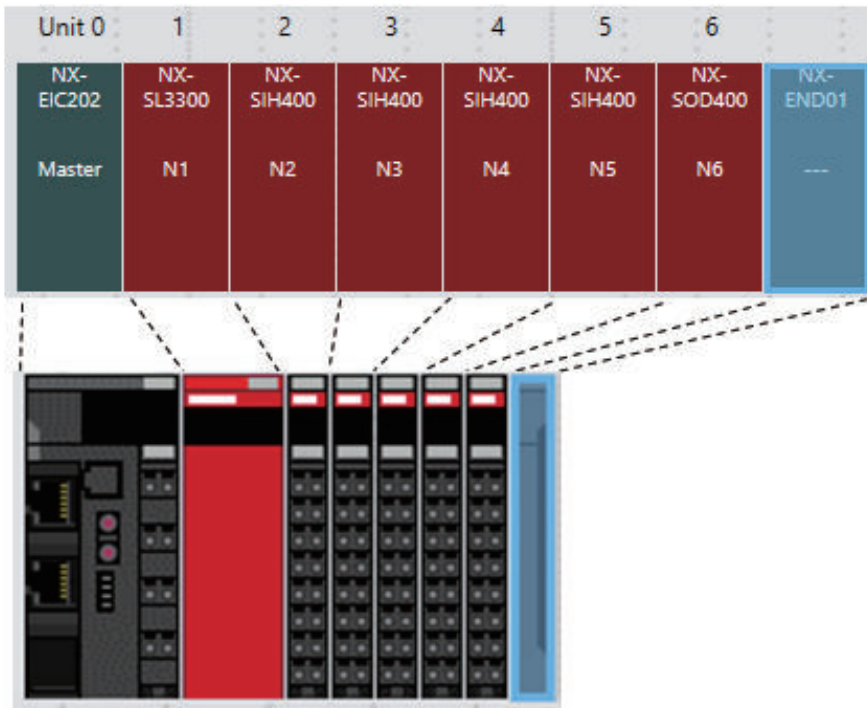

## Wiring the Power Supplies

The power supply wirings and grounding for the EtherNet/IP Coupler Unit are shown in the figure below.

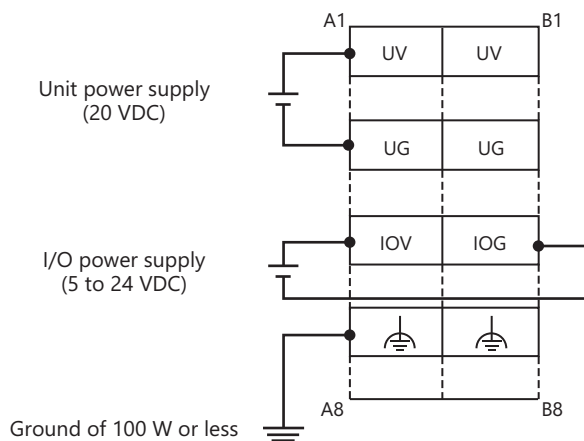

- Connect the + terminal (24 VDC) of the Unit power supply to A1 or B1.
- Connect the - terminal (0 VDC) of the Unit power supply to A3 or B3.
- Connect the + terminal (5 to 24 VDC) of the I/O power supply to A5.
- Connect the - terminal (0 VDC) of the I/O power supply to B5.
- Connect the ground line to A7 or B7.

### Wiring the Emergency Stop Pushbutton Switch

Connect the emergency stop pushbutton switch to the Safety Input Unit (N2).

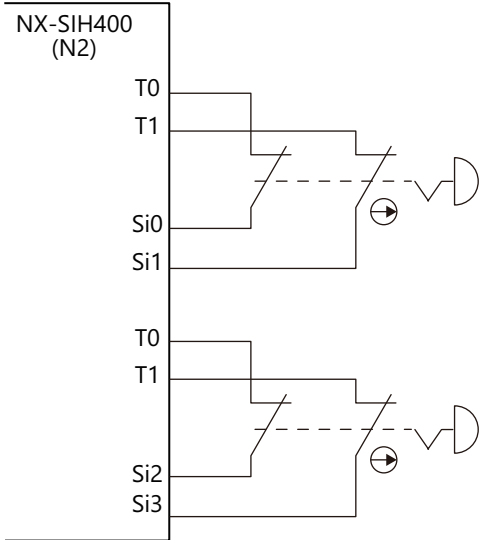

### Wiring the Safety Light Curtain

Connect the safety light curtain to the I/O power supply and Safety Input Unit (N3).

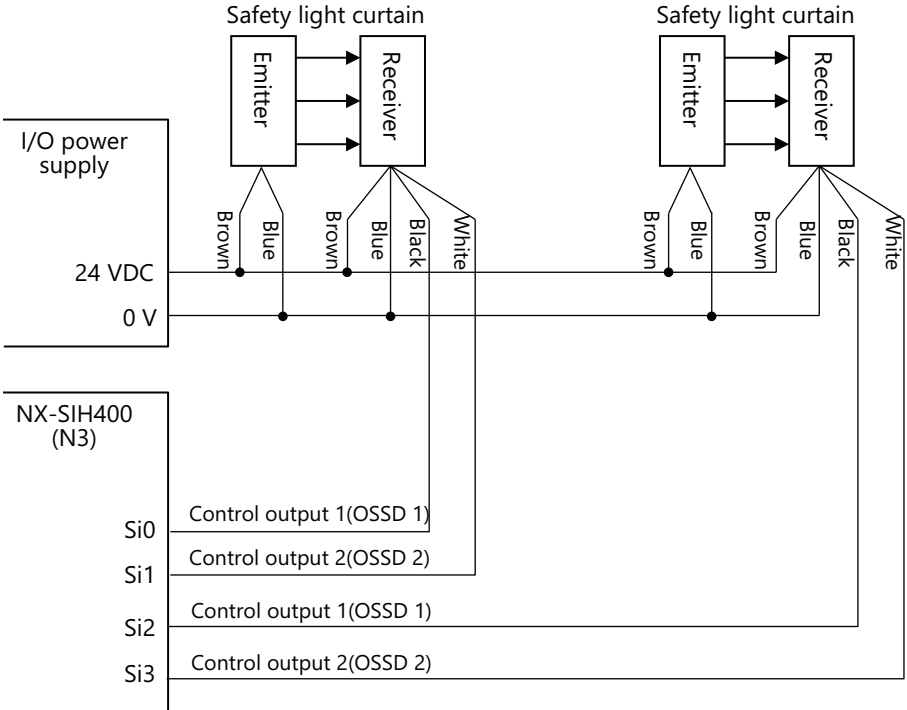

### Wiring the Safety Door Switch

Connect the non-contact door switch to the I/O power supply and Safety Input Unit (N4).

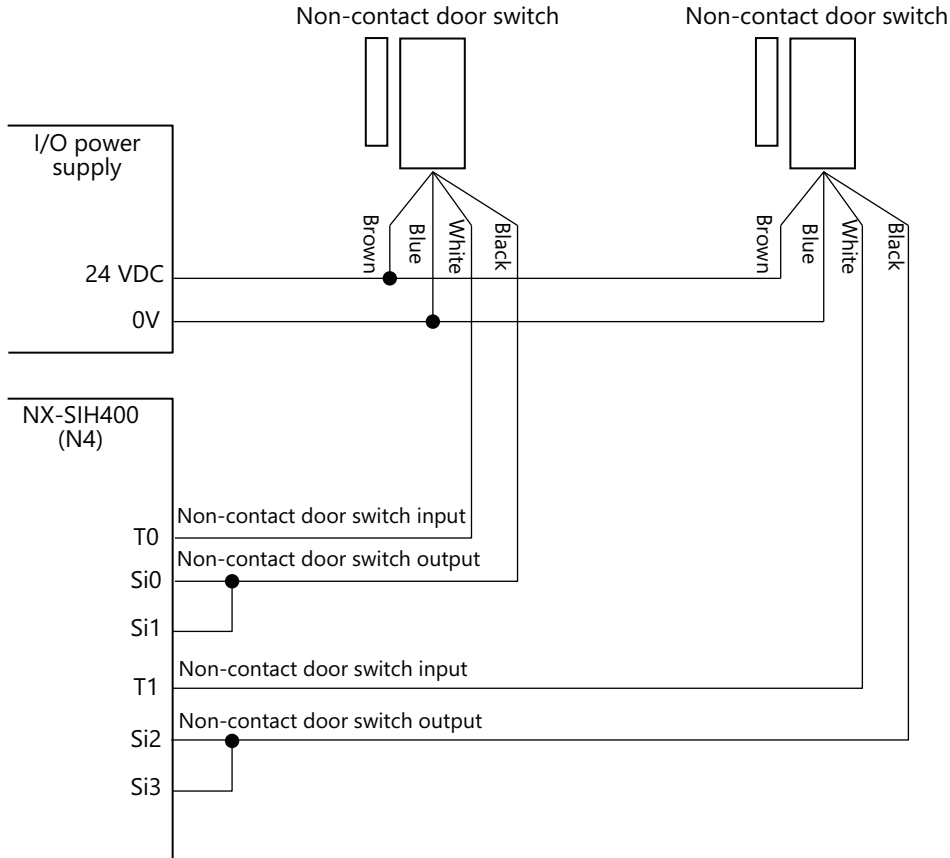

## Wiring the Reset Switch

Connect the reset switch to the Safety Input Unit (N5).

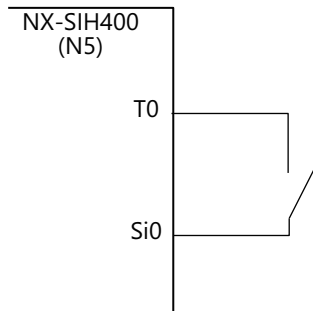

## Wiring the Robot

Connect the robot to the Safety Output Unit (N6), Safety Input Unit (N5) and safety relays. The outputs of the Safety Output Unit (N6) and the inputs of the robot cannot be directly connected, therefore they are connected through the safety relays. Use the contact a of each safety relay L1 to L4.

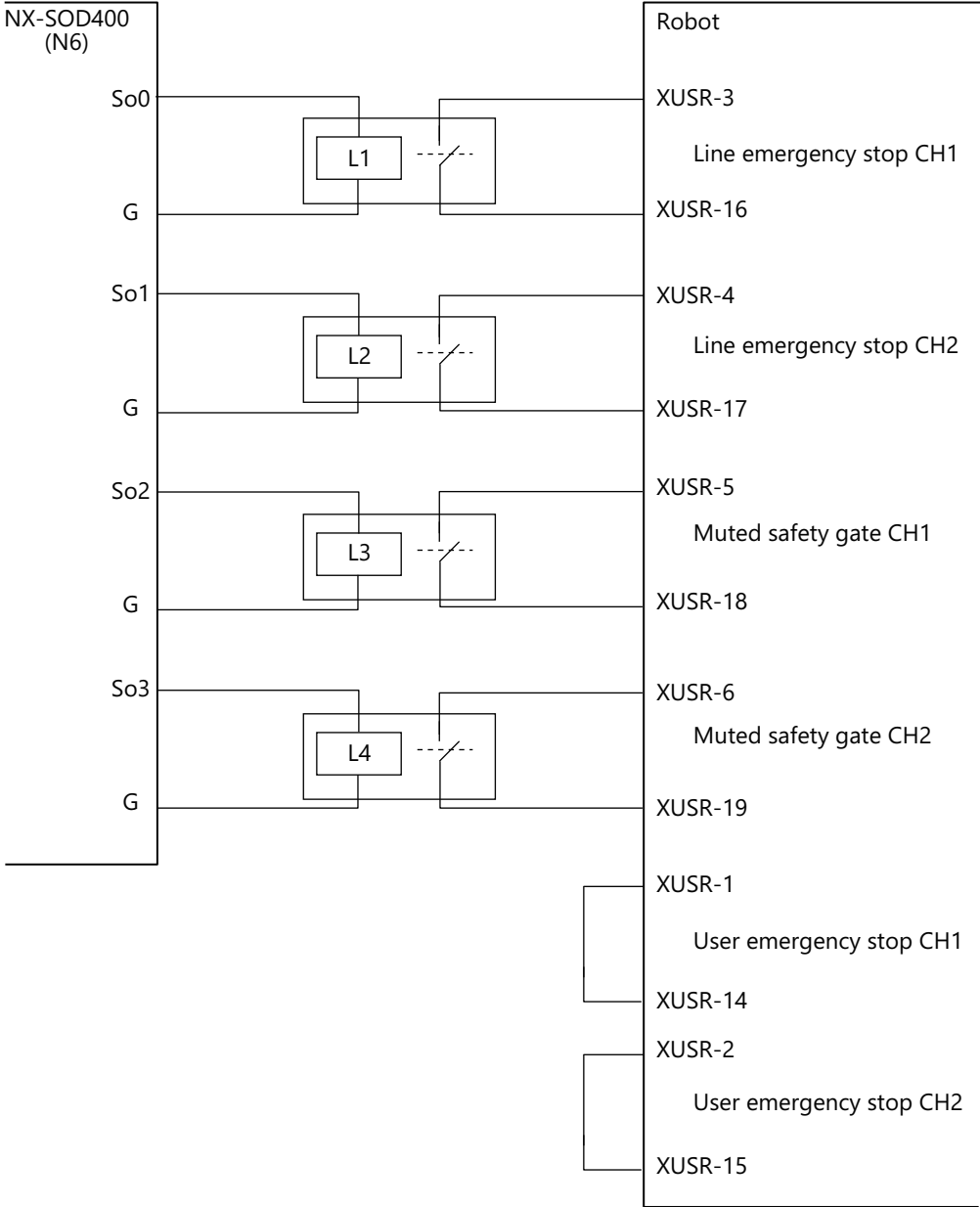

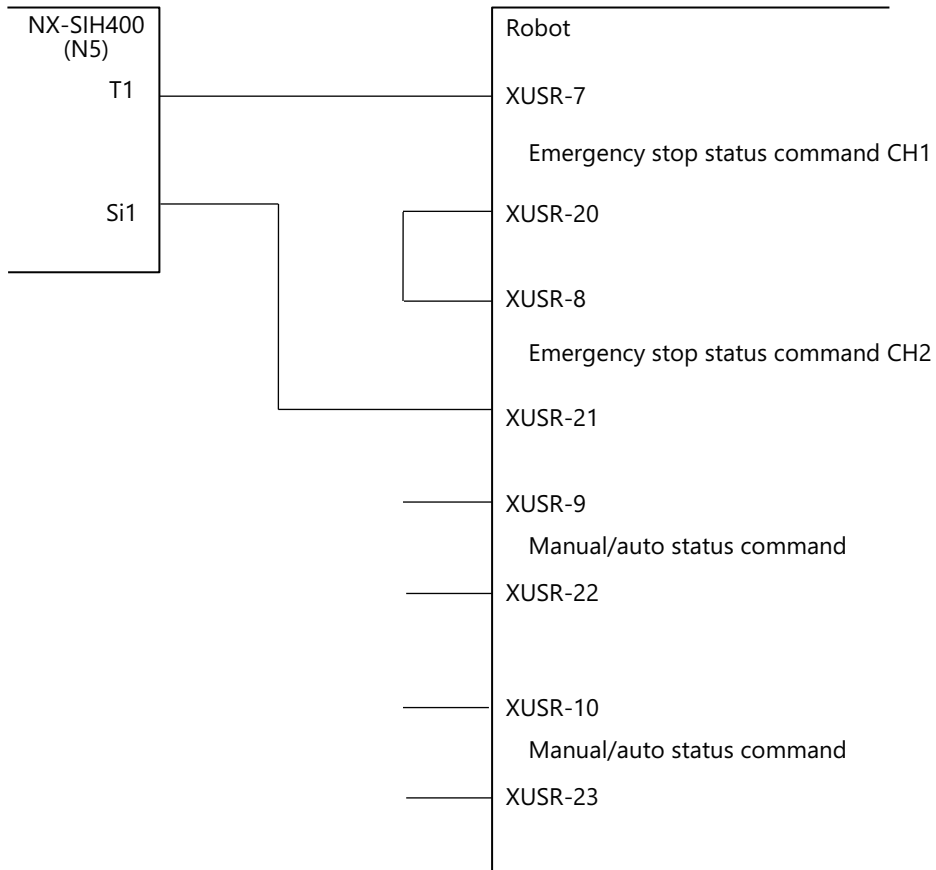

## Wiring the Safety Relays for Operation Check

Connect the contact b of each safety relay L1 to L4 to the Safety Input Unit (N5) for checking the operation of each contact a.



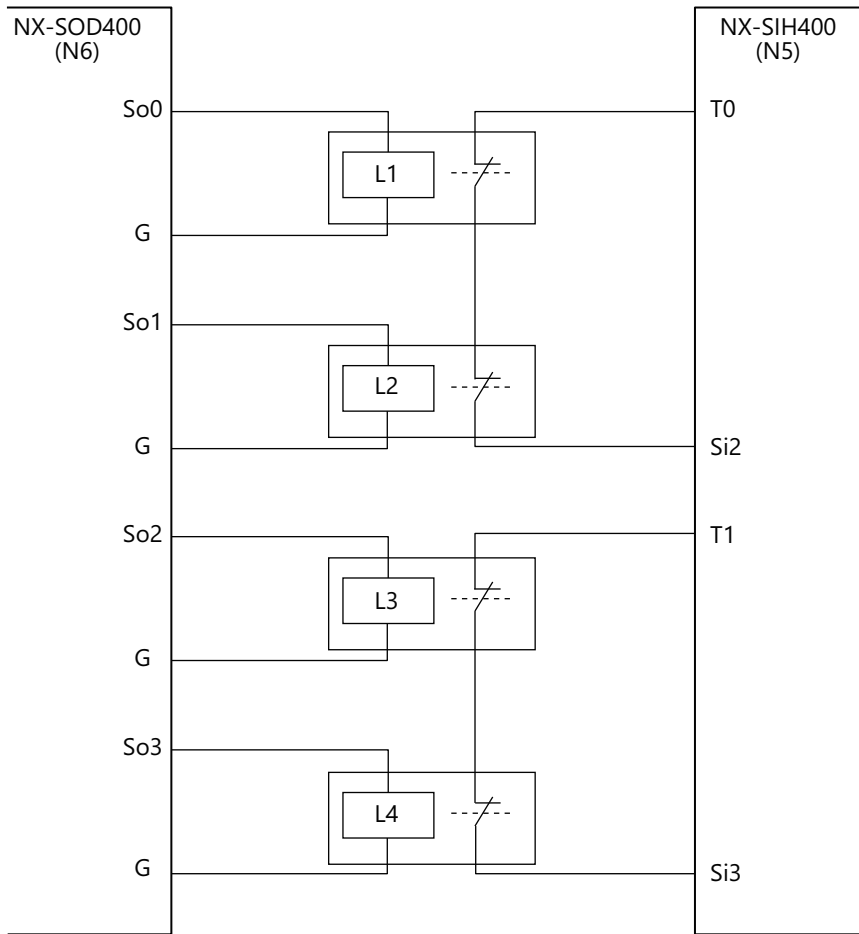

## A-1-7 Settings and Programming

This section describes the settings and programming related to the safety functions.

Refer to the *NX-series Safety Control Unit Instructions Reference Manual (Cat. No. Z931)* for information on the instructions for the Safety CPU Unit.

Refer to the *NX-series Safety Control Unit User's Manual (Cat. No. Z930)* for information on the specifications and how to configure the Safety Control Units.

### Setting Safety I/O Unit

Use the Sysmac Studio and set the safety functions of each safety I/O terminal.

Set the Safety Input Unit (N2) as shown below.

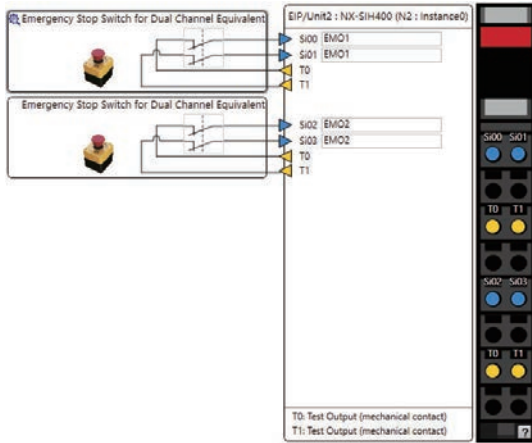

Set the Safety Input Unit (N3) as shown below.

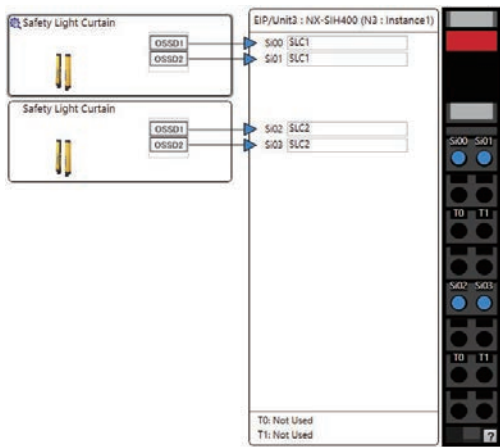

Set the Safety Input Unit (N4) as shown below.

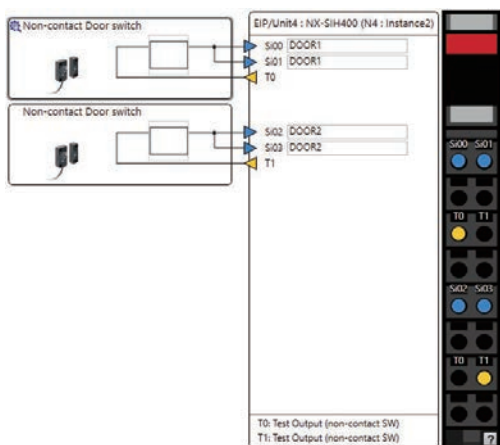

Set the Safety Input Unit (N5) as shown below.

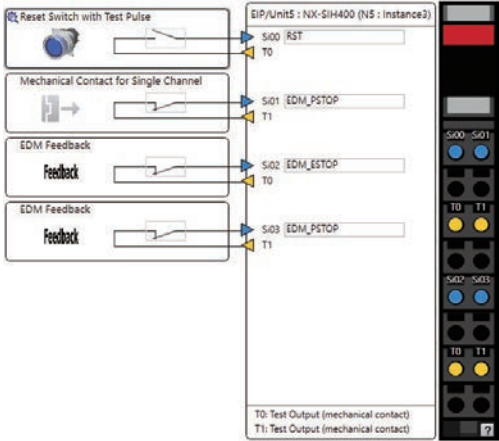

Set the Safety Output Unit (N6) as shown below.

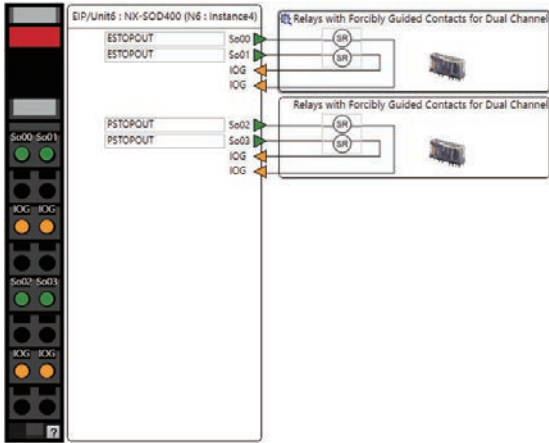

### Registering Device Variables

Use the Sysmac Studio and set the device variables of each Safety I/O Unit.

Position	Port	R/W	Data Type	Variable	Variable Comment	Variable Type
	▼ NX Bus					
NX Bus Master	Master					
EIP/Unit2	▼ NX-SIH400					
	▼ Safety Inputs and Status					
	Si00 Logical Value	R	SAFEBOOL	EMO1	EMO1	Global Variables
	Si01 Logical Value	R	SAFEBOOL		EMO1	
	Si02 Logical Value	R	SAFEBOOL	EMO2	EMO2	Global Variables
	Si03 Logical Value	R	SAFEBOOL		EMO2	
	Safety Connection Status	R	SAFEBOOL	N2_Safety_Connection_Status		Global Variables
	Safety Input Terminal Status	R	SAFEBOOL			
EIP/Unit3	▼ NX-SIH400					
	▼ Safety Inputs and Status					
	Si00 Logical Value	R	SAFEBOOL	SLC1	SLC1	Global Variables
	Si01 Logical Value	R	SAFEBOOL		SLC1	
	Si02 Logical Value	R	SAFEBOOL	SLC2	SLC2	Global Variables
	Si03 Logical Value	R	SAFEBOOL		SLC2	
	Safety Connection Status	R	SAFEBOOL	N3_Safety_Connection_Status		Global Variables
	Safety Input Terminal Status	R	SAFEBOOL			
EIP/Unit4	▼ NX-SIH400					
	▼ Safety Inputs and Status					
	Si00 Logical Value	R	SAFEBOOL	DOOR1	DOOR1	Global Variables
	Si01 Logical Value	R	SAFEBOOL		DOOR1	
	Si02 Logical Value	R	SAFEBOOL	DOOR2	DOOR2	Global Variables
	Si03 Logical Value	R	SAFEBOOL		DOOR2	
	Safety Connection Status	R	SAFEBOOL	N4_Safety_Connection_Status		Global Variables
	Safety Input Terminal Status	R	SAFEBOOL			
EIP/Unit5	▼ NX-SIH400					
	▼ Safety Inputs and Status					
	Si00 Logical Value	R	SAFEBOOL	RST	RST	Global Variables
	Si01 Logical Value	R	SAFEBOOL	LOCALSTOP	LOCALSTOP	Global Variables
	Si02 Logical Value	R	SAFEBOOL	EDM_ESTOP	EDM_ESTOP	Global Variables
	Si03 Logical Value	R	SAFEBOOL	EDM_PSTOP	EDM_PSTOP	Global Variables
	Safety Connection Status	R	SAFEBOOL	N5_Safety_Connection_Status		Global Variables
	Safety Input Terminal Status	R	SAFEBOOL			
EIP/Unit6	▼ NX-SOD400					
	▼ Status					
	Safety Connection Status	R	SAFEBOOL	N6_Safety_Connection_Status		Global Variables
	Safety Output Terminal Status	R	SAFEBOOL			
	▼ Safety Outputs					
	So00 Output Value	W	SAFEBOOL	ESTOPOUT	ESTOPOUT	Global Variables
	So01 Output Value	W	SAFEBOOL		ESTOPOUT	
	So02 Output Value	W	SAFEBOOL	PSTOPOUT	PSTOPOUT	Global Variables
	So03 Output Value	W	SAFEBOOL		PSTOPOUT	

## Safety Programs

Use the Sysmac Studio to create variables and programs as shown below.

Create variables as shown below.

Internals	Name	Data Type	Initial Value	Constant	Comment
Externals	OC_ResetSignal_0	OC_ResetSignal		<input type="checkbox"/>	
	RST_Out	BOOL	FALSE	<input type="checkbox"/>	
	SF_EmergencyStop_0	SF_EmergencyStop		<input type="checkbox"/>	EMO1
	EMO1_Out	SAFEBOOL	FALSE	<input type="checkbox"/>	
	SF_EmergencyStop_1	SF_EmergencyStop		<input type="checkbox"/>	EMO2
	EMO2_Out	SAFEBOOL	FALSE	<input type="checkbox"/>	
	SF_ESPE_0	SF_ESPE		<input type="checkbox"/>	SLC1
	SLC1_Out	SAFEBOOL	FALSE	<input type="checkbox"/>	
	SF_ESPE_1	SF_ESPE		<input type="checkbox"/>	SLC2
	SLC2_Out	SAFEBOOL	FALSE	<input type="checkbox"/>	
	SF_GuardMonitoring_0	SF_GuardMonitori...		<input type="checkbox"/>	DOOR1
	DOOR1_Out	SAFEBOOL	FALSE	<input type="checkbox"/>	
	SF_GuardMonitoring_1	SF_GuardMonitori...		<input type="checkbox"/>	DOOR2
	DOOR2_Out	SAFEBOOL	FALSE	<input type="checkbox"/>	
	SF_EmergencyStop_2	SF_EmergencyStop		<input type="checkbox"/>	LOCALSTOP
	LOCALSTOP_Out	SAFEBOOL	FALSE	<input type="checkbox"/>	
	ESTOPOUT_In	SAFEBOOL	FALSE	<input type="checkbox"/>	
	PSTOPOUT_In	SAFEBOOL	FALSE	<input type="checkbox"/>	
	SF_EDM_0	SF_EDM		<input type="checkbox"/>	ESTOPOUT
	SF_EDM_1	SF_EDM		<input type="checkbox"/>	PSTOPOUT
	Activate	SAFEBOOL	FALSE	<input type="checkbox"/>	

Internals	Name	Data Type	Constant	Comment
Externals	RST	SAFEBOOL	<input type="checkbox"/>	
	EMO1	SAFEBOOL	<input type="checkbox"/>	
	EMO2	SAFEBOOL	<input type="checkbox"/>	
	SLC1	SAFEBOOL	<input type="checkbox"/>	
	SLC2	SAFEBOOL	<input type="checkbox"/>	
	DOOR1	SAFEBOOL	<input type="checkbox"/>	
	DOOR2	SAFEBOOL	<input type="checkbox"/>	
	LOCALSTOP	SAFEBOOL	<input type="checkbox"/>	
	ESTOPOUT	SAFEBOOL	<input type="checkbox"/>	
	PSTOPOUT	SAFEBOOL	<input type="checkbox"/>	
	N2_Safety_Connection_Status	SAFEBOOL	<input type="checkbox"/>	
	N3_Safety_Connection_Status	SAFEBOOL	<input type="checkbox"/>	
	N4_Safety_Connection_Status	SAFEBOOL	<input type="checkbox"/>	
	N5_Safety_Connection_Status	SAFEBOOL	<input type="checkbox"/>	
	N6_Safety_Connection_Status	SAFEBOOL	<input type="checkbox"/>	
	EDM_ESTOP	SAFEBOOL	<input type="checkbox"/>	
	EDM_PSTOP	SAFEBOOL	<input type="checkbox"/>	

Create programs as shown below.

1

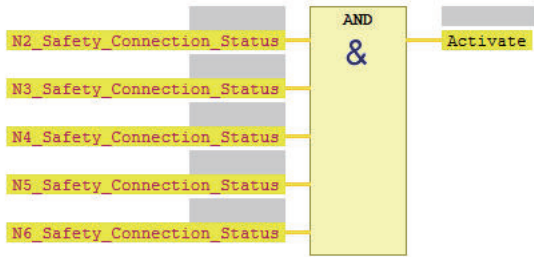

2

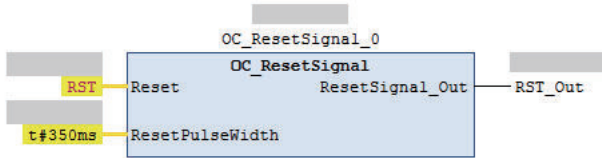

3

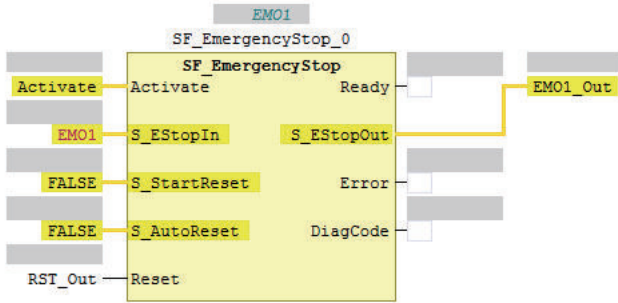

4

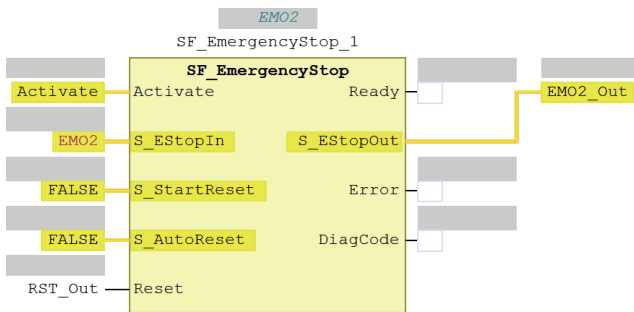

5

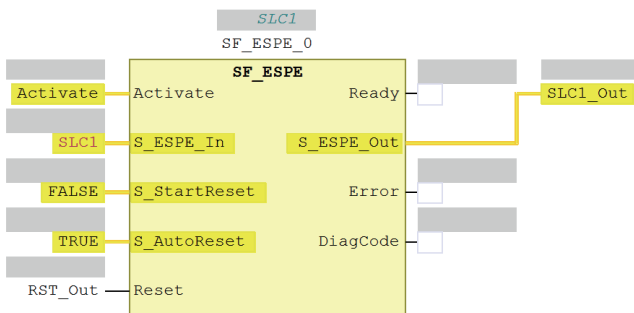

6

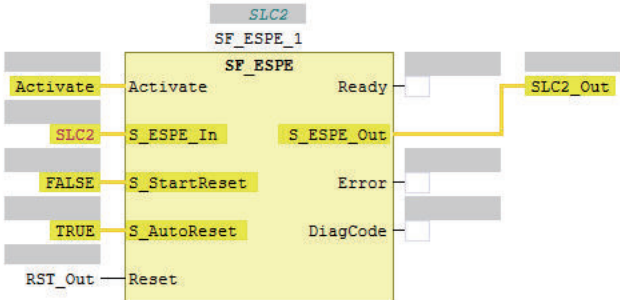

7

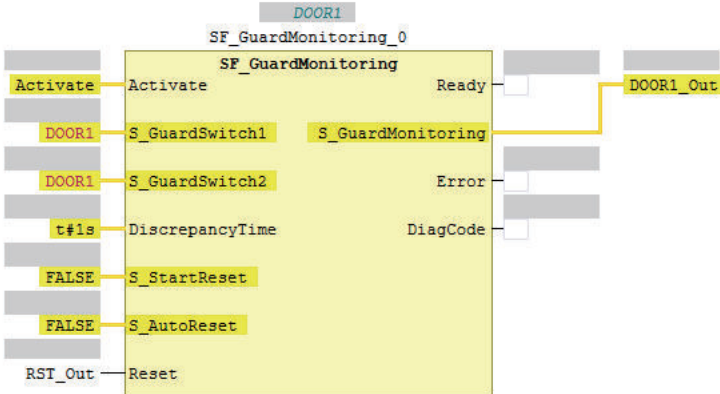

8

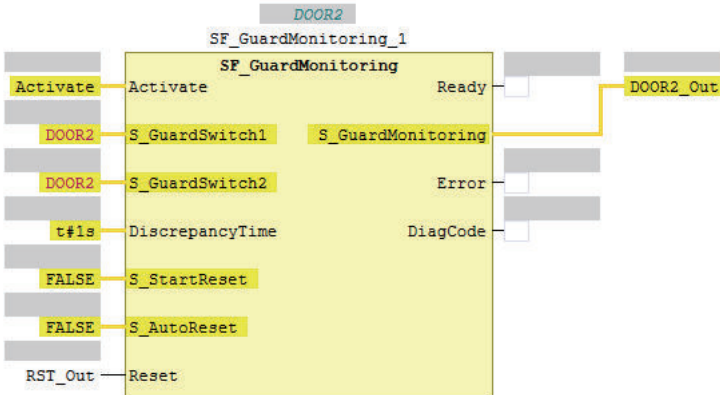

9

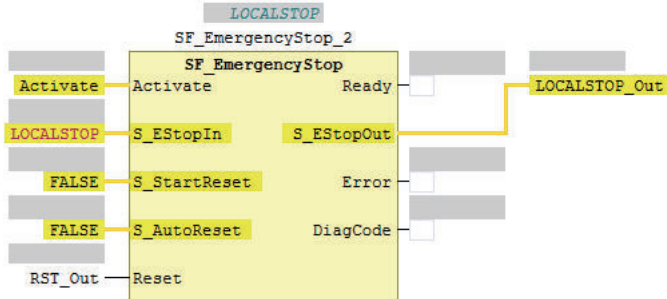

10

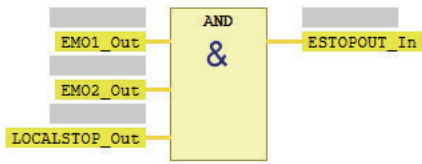

11

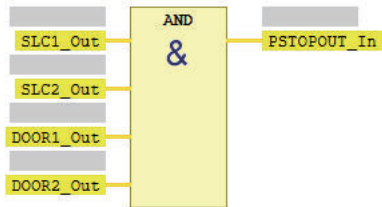

12

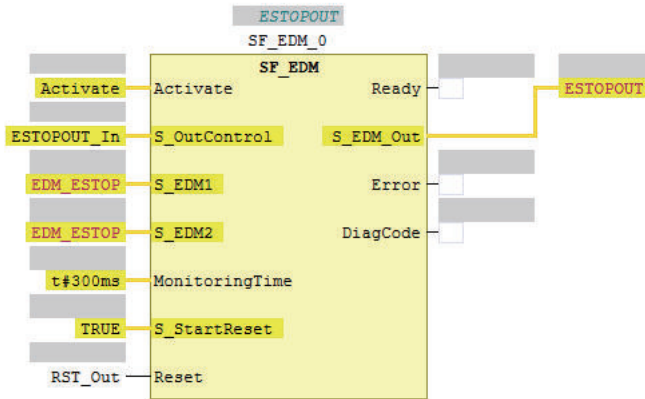

13

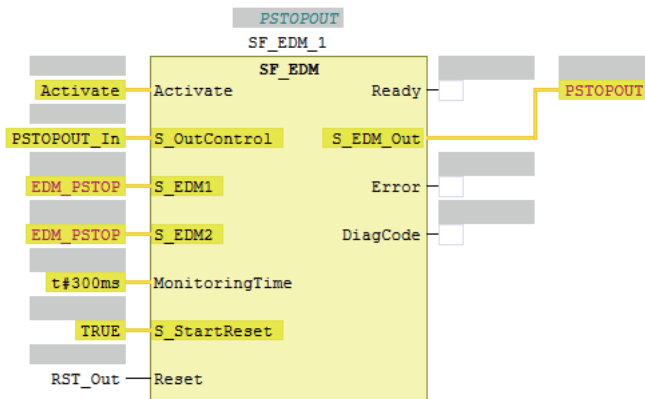



# A-2 How to Use 3D Visualizer

This section describes methods to manipulate the viewpoint on a robot simulation. Operations are performed on the 3D Visualizer in Sysmac Studio.

## A-2-1 Set the 3D Visualizer to the Float Mode

The 3D Visualizer is displayed in the Dock mode by default in Sysmac Studio.

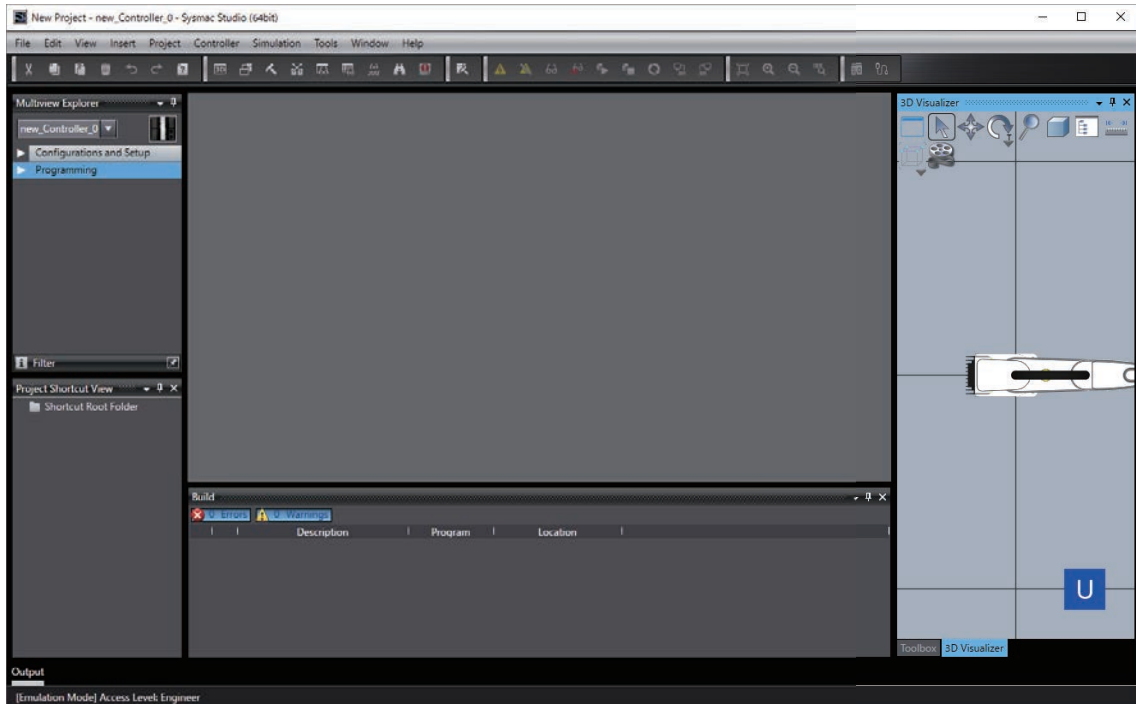

To enlarge the 3D Visualizer, display it in the Float mode, then resize it.

- 1 Right-click the 3D Visualize tab, then select **Float** from the menu.



The 3D Visualizer gets into the Float mode.

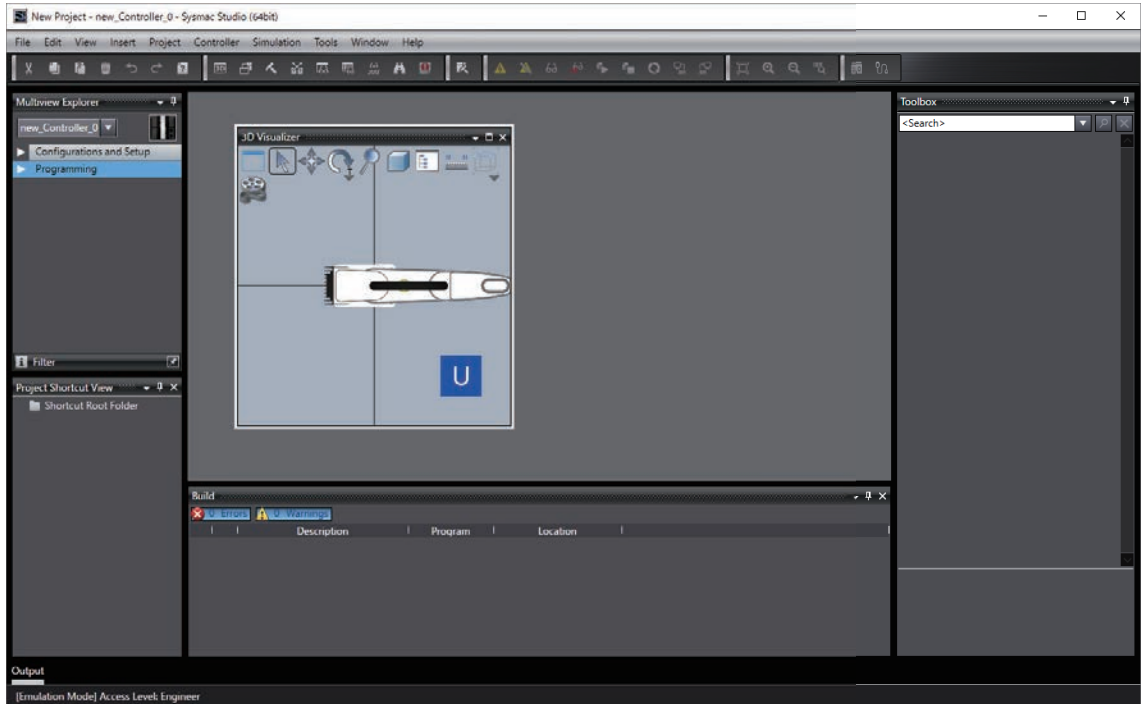

- 2 Click on the 3D visualizer frame and drag it until the 3D Visualizer gets large enough.

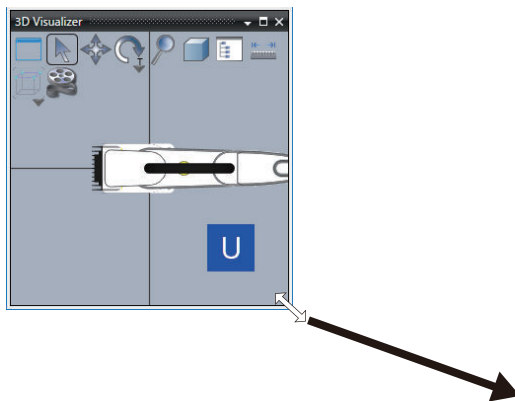

The 3D Visualizer is enlarged.

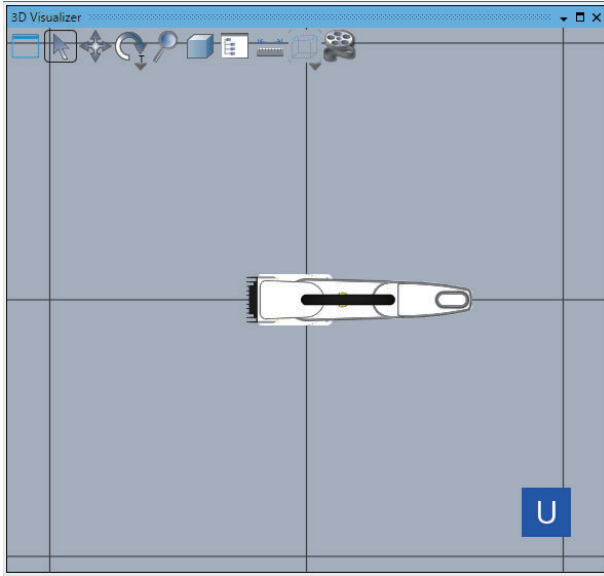

## A-2-2 Rotate the Viewpoint

The following two methods are available to rotate the viewpoint:

- Using the 3D View Switching Tool
- Using the **Rotate** icon

This section provides the information about these two methods to rotate the viewpoint in the 3D Visualizer.

### 3D View Switching Tool

The 3D View Switching Tool displayed at the right bottom of the window allows to switch the viewpoint. The 3D View Switching Tool consists of three elements: Face, Corner, and Edge. The operation procedure is illustrated with an example.

- 1 Put the mouse pointer over the right edge of **U**. Then the pointed place turns black.

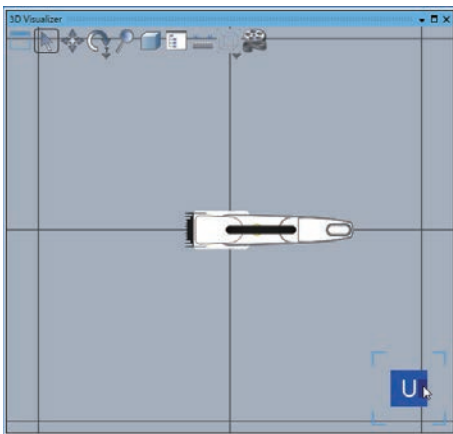

- 2 Click it, then the view is switched so that the clicked side faces you.

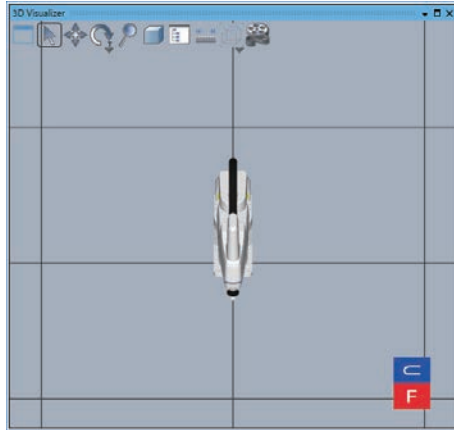

Clicking the left corner changes the view as shown below.

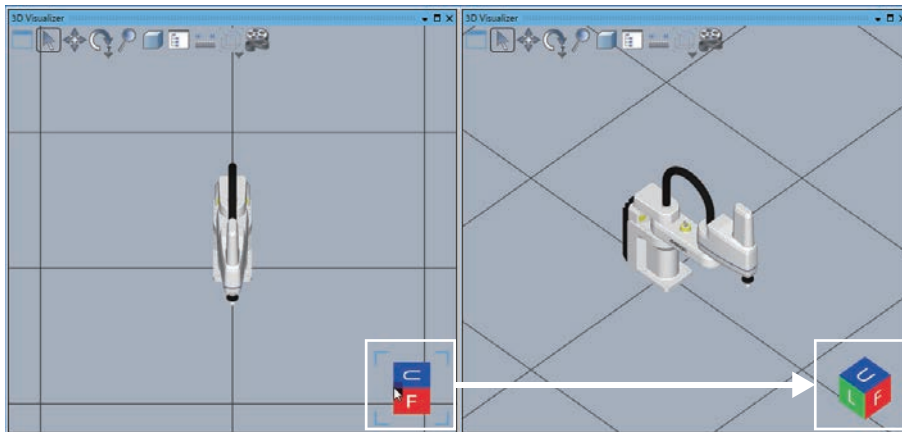

## Rotate icon

This section describes how to rotate the viewpoint by using the **Rotate** icon of the 3D Visualizer.

- 1 Click the **Rotate** icon on the 3D Visualizer.

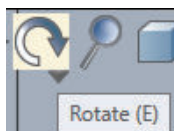

An icon that shows the mouse pointer can rotate the viewpoint appears.



- 2 Press and hold down the left button of the mouse, then drag to the direction you want to rotate the viewpoint.

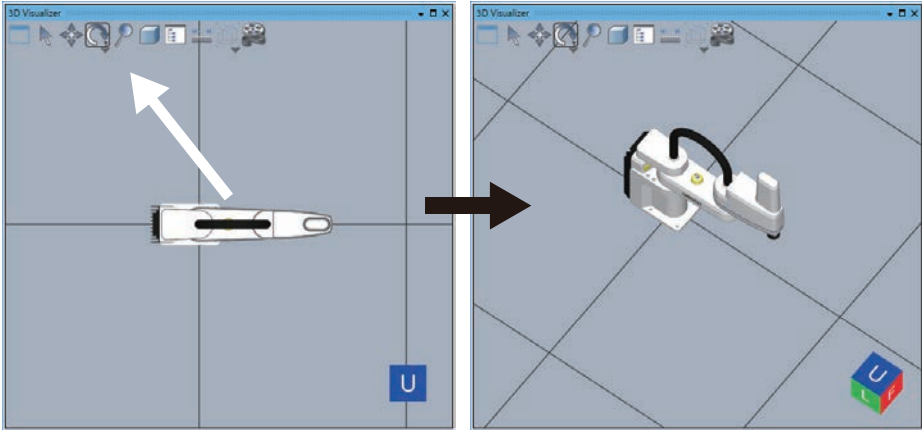

- Drag upward: Move the viewpoint downward
- Drag downward: Move the viewpoint upward
- Drag to the right: Move the viewpoint to the left
- Drag to the left: Move the viewpoint to the right

There are two modes in rotation.

Mode	Description
Tumbler rotation	A 3D shape data can be viewed from any angle.
Turntable rotation	The viewpoint can be rotated clockwise or counterclockwise around the Z-axis of the world coordinate system. Or the 3D shape data can be viewed in the range of $\pm 90^\circ$ vertically.

A-2 How to Use 3D Visualizer

A

A-2-3 Translate the Viewpoint

### A-2-3 Translate the Viewpoint

This section describes how to move the viewpoint on the 3D Visualizer. Move the viewpoint downward so that you can see the entire robot.

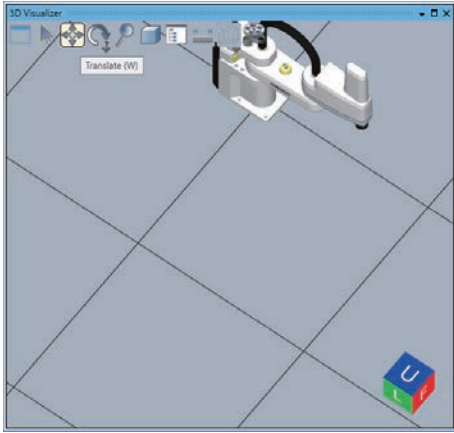

- 1 Click the **Translate** icon on the 3D Visualizer.

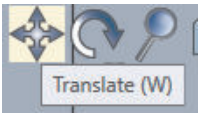

An icon that shows the mouse pointer can translate the viewpoint on the 3D Visualizer appears.



- 2 Press and hold down the left button of the mouse, then drag to the direction you want to translate the viewpoint.

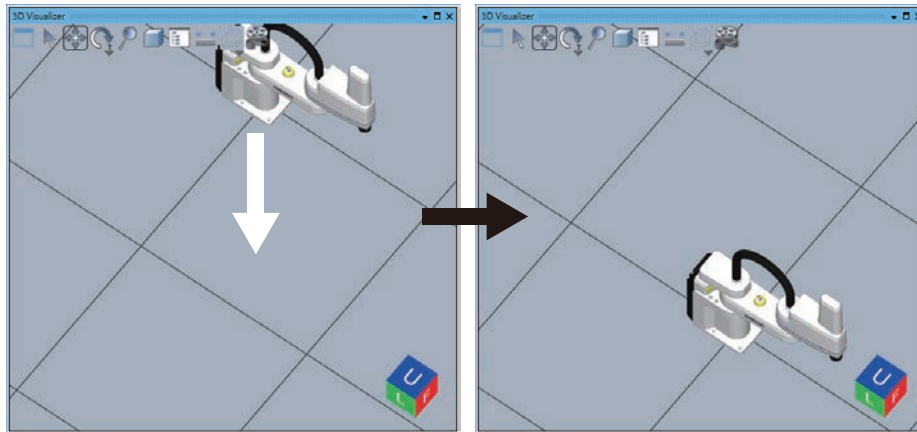

#### Additional Information

In addition to the operation mentioned above, pressing the mouse wheel and dragging to an intended direction can translate the viewpoint.

## A-2-4 Zoom-in and Zoom-out

This section describes how to zoom in or out on the 3D Visualizer.

- 1 Click the **Zoom** icon on the 3D Visualizer.



An icon that shows the mouse pointer can zoom appears.



- 2 Press and hold down the left button of the mouse, then drag it.  
 Drag to the right: Enlarge the size (Zoom-in)  
 Drag to the left: Reduce the size (Zoom-out)

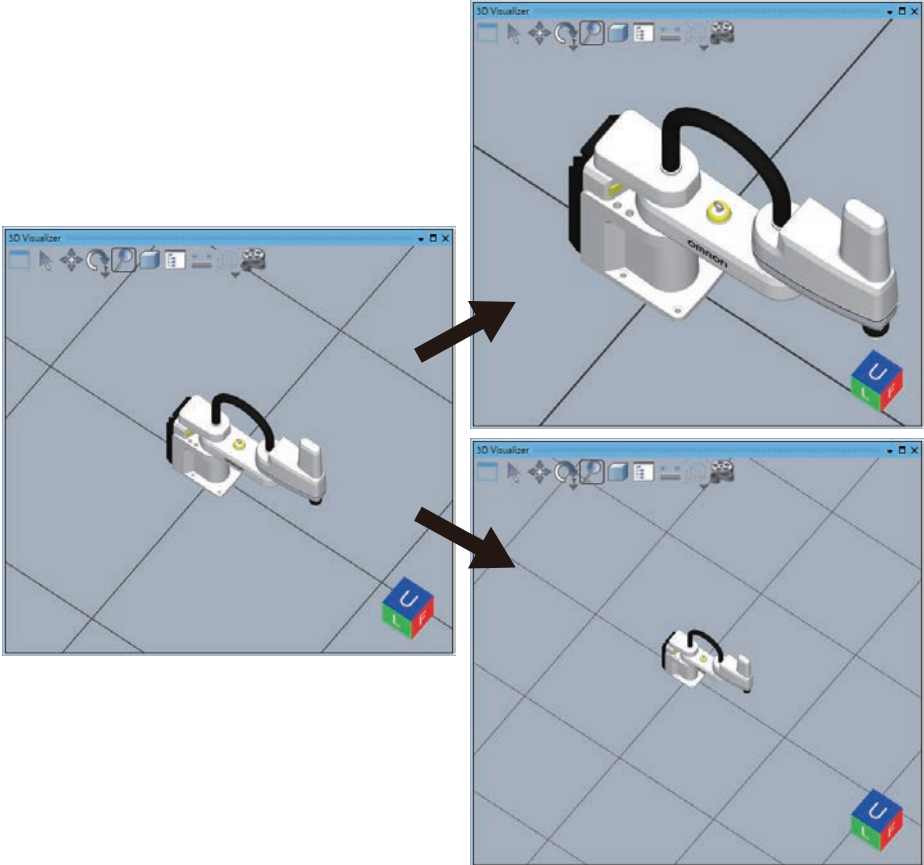

**Additional Information**

Rotating the mouse wheel also enables zoom-in or -out.  
The position of the mouse pointer represents the center of zooming in or out.

# A-3 Setting Items on the Sysmac Studio and the Setting Targets

The correspondences between the items in the Multiview Explorer of the Sysmac Studio and each hardware are provided below.

If you select **ApplicationManager0** for the device in the Multiview Explorer, the settings for the Application Manager of the IPC Application Controller are available. If you select **new\_Controller\_0**, the settings for a sequence control program of the Robot Integrated CPU Unit, and if you select **RobotControlSettings**, the settings for a V+ program of the Robot Integrated CPU Unit are available. Refer to the product manuals for details.

Setting items in the MultiView Explorer

Setting target

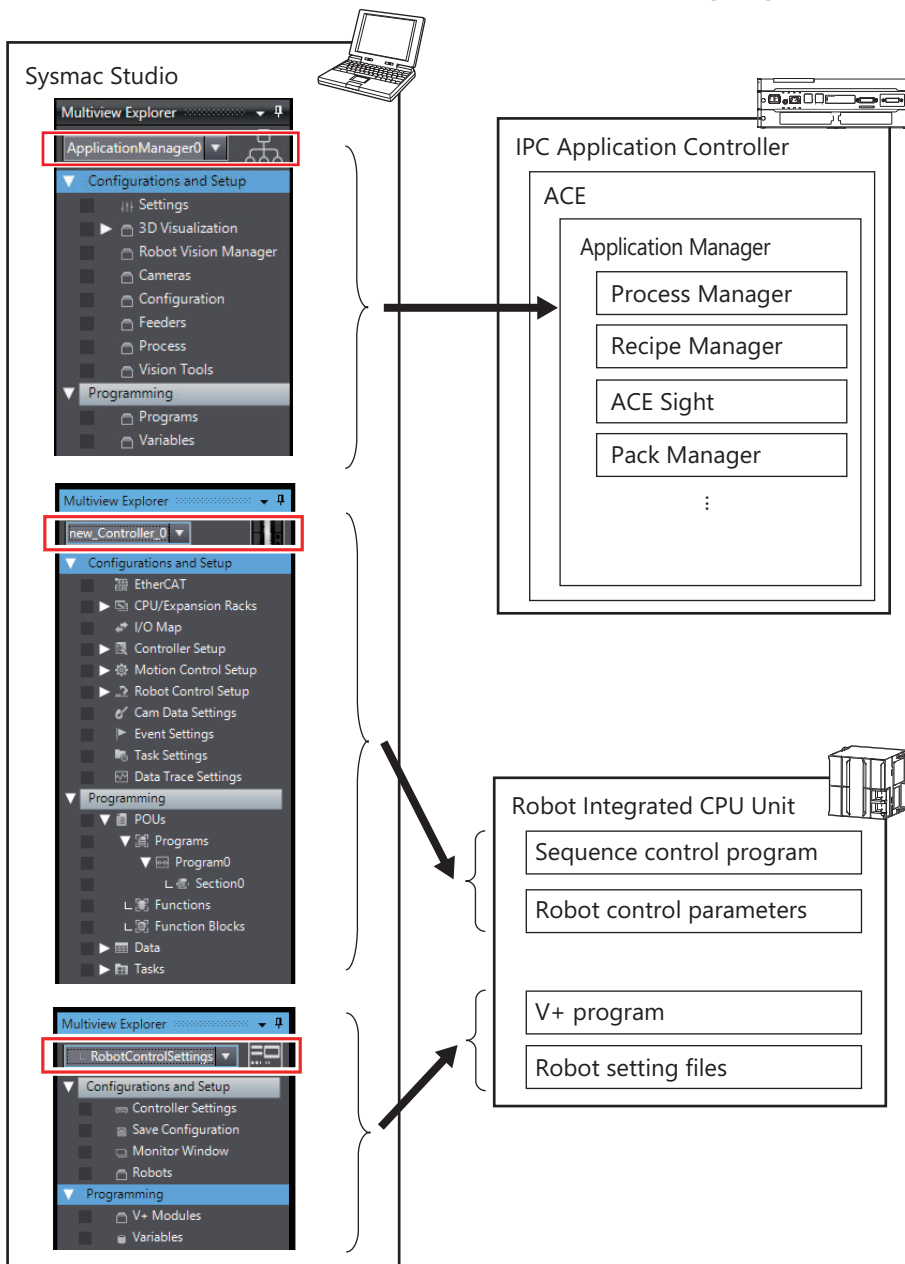



# A-4 Using Troubleshooting Functions

---

Refer to the *Sysmac Studio Robot Integrated System Building Function with Robot Integrated CPU Unit Operation Manual (Cat. No. W595)* for the operation procedure of the troubleshooting functions on the Sysmac Studio.





**OMRON Corporation** Industrial Automation Company  
Kyoto, JAPAN

Contact: [www.ia.omron.com](http://www.ia.omron.com)

**Regional Headquarters**

**OMRON EUROPE B.V.**

Wegalaan 67-69, 2132 JD Hoofddorp  
The Netherlands  
Tel: (31)2356-81-300/Fax: (31)2356-81-388

**OMRON ELECTRONICS LLC**

2895 Greenspoint Parkway, Suite 200  
Hoffman Estates, IL 60169 U.S.A.  
Tel: (1) 847-843-7900/Fax: (1) 847-843-7787

**OMRON ASIA PACIFIC PTE. LTD.**

No. 438A Alexandra Road # 05-05/08 (Lobby 2),  
Alexandra Technopark,  
Singapore 119967  
Tel: (65) 6835-3011/Fax: (65) 6835-2711

**OMRON (CHINA) CO., LTD.**

Room 2211, Bank of China Tower,  
200 Yin Cheng Zhong Road,  
PuDong New Area, Shanghai, 200120, China  
Tel: (86) 21-5037-2222/Fax: (86) 21-5037-2200

**Authorized Distributor:**

© OMRON Corporation 2020 - 2022 All Rights Reserved.  
In the interest of product improvement,  
specifications are subject to change without notice.

**Cat. No. O049-E1-04**

0322