

**OMRON****ST****Type G9SX-SM032-□**  
Standstill Monitoring Unit**English****USER'S MANUAL**

Thank you for purchasing G9SX Standstill Monitoring Unit.

Please read and understand this manual before using the products.

Keep this manual ready to use whenever needed.

Only qualified person trained in professional electrical technique should handle G9SX.

Please consult your OMRON representative if you have any questions or comments.

Make sure that information written in this document are delivered to the final user of the product.

**OMRON Corporation**

© OMRON Corporation 2008-2020 All Rights Reserved. 3080529-6 F

**EU Declaration of Conformity**

OMRON declares that G9SX-SM□ is in conformity with the requirements of the following EU Directives:

EMC Directive 2014/30/EU

Machinery Directive 2006/42/EC

**Standards**

G9SX-SM□ is designed and manufactured in accordance with the following standards:

EN ISO13849-1:2015 Category 4 PL e,

IEC/EN61508 SIL3, IEC/EN62061 SIL3,

IEC/EN61000-6-2, IEC/EN61000-6-4,

UL508,

CAN/CSA C22.2 No.142

**Safety Precautions****Meanings of Signal Words**

The following signal words are used in this manual.



Indicates a potentially hazardous situation which, if not avoided, will result in minor or moderate injury, or may result in serious injury or death.  
Additionally there may be significant property damage.

**Meaning of Alert Symbols**

The following alert symbols are used in this manual.





Indicates prohibited actions.





Indicates mandatory actions.

**Alert Statements****WARNING**

Serious injury may possibly occur due to breakdown of safety outputs.  
Do not connect loads beyond the rated value to the safety outputs. 

Serious injury may possibly occur due to loss of required safety functions.  
Do not use G9SX-SM in the system where plurality of motors are driven by one inverter or contactor. 

Serious injury may possibly occur due to loss of required safety functions.  
Wire G9SX properly so that supply voltages or voltages for loads do NOT touch safety outputs accidentally or unintentionally. 

Serious injury may possibly occur due to damages of safety outputs.  
Apply protection circuitry against back electromotive force in case connecting inductive loads to safety outputs. 

Serious injury may occur due to failure of safety functions.  
Operate the motor at rated G9SX-SM input frequency (120Hz) or less. 

Serious injury may possibly occur due to loss of safety functions.  
Use appropriate devices referring to the information provided below. 

Controlling Devices	Requirements
Guard Lock Safety-door Switch	Use approved devices with Direct Opening Mechanism complying with IEC/EN 60947-5-1, mechanical lock type and capable of solenoid coil 24VDC, less than 300mA.
Relay with forcibly guided contacts	Use approved devices with forcibly guided contacts complying with IEC 61810-3 (EN 50205). For feedback purpose use devices with contacts capable of switching micro loads of 24VDC, 5mA.
Contactors	Use approved devices complying with IEC/EN 60947-4-1 auxiliary contact linked with power contact (mirror contact). For feedback purpose use devices with contacts capable of switching micro loads of 24VDC, 5mA.
Other devices	Evaluate whether devices used are appropriate to satisfy the requirements of safety category level.

**Suitability for Use**

Omron Companies shall not be responsible for conformity with any standards, codes or regulations which apply to the combination of the Product in the Buyer's application or use of the Product. At Buyer's request, Omron will provide applicable third party certification documents identifying ratings and limitations of use which apply to the Product. This information by itself is not sufficient for a complete determination of the suitability of the Product in combination with the end product, machine, system, or other application or use. Buyer shall be solely responsible for determining appropriateness of the particular Product with respect to Buyer's application, product or system. Buyer shall take application responsibility in all cases.

**NEVER USE THE PRODUCT FOR AN APPLICATION INVOLVING SERIOUS RISK TO LIFE OR PROPERTY OR IN LARGE QUANTITIES WITHOUT ENSURING THAT THE SYSTEM AS A WHOLE HAS BEEN DESIGNED TO ADDRESS THE RISKS, AND THAT THE OMRON PRODUCT(S) IS PROPERLY RATED AND INSTALLED FOR THE INTENDED USE WITHIN THE OVERALL EQUIPMENT OR SYSTEM.**

## Precautions for Safe Use

- (1) Use G9SX-SM□ within an enclosure with IP54 protection or higher according to IEC/EN60529. Be sure to connect the enclosure to earth(PE).
- (2) Incorrect wiring may lead to loss of safety function. Wire conductors correctly and verify the operation of G9SX-SM□ before using the system in which G9SX-SM□ is incorporated.
- (3) Do not apply DC voltages exceeding the rated voltages, nor any AC voltages to G9SX-SM□. Do not connect to DC distribution network.
- (4) Use DC supply satisfying requirements below to prevent electric shock.
  - DC power supply with double or reinforced insulation, for example, according to IEC/EN60950 or EN50178 or a transformer according to IEC/EN61558.
  - DC supply satisfies the requirement for class 2 circuits or limited voltage/current circuit stated in UL 508.
- (5) Apply properly specified voltages to G9SX-SM□ inputs. Applying inappropriate voltages cause G9SX-SM□ to fail to perform its specified function, which leads to the loss of safety functions or damages to G9SX-SM□.
- (6) Auxiliary error outputs and auxiliary monitoring outputs are NOT safety outputs. Do not use auxiliary outputs as any safety output. Such incorrect use causes loss of safety function of G9SX-SM□ and its relevant system.
- (7) After installation of G9SX-SM□, qualified personnel should confirm the installation, and should conduct test operations and maintenance. The qualified personnel should be qualified and authorized to secure the safety on each phases of design, installation, running, maintenance and disposal of system.
- (8) A person in charge, who is familiar to the machine in which G9SX-SM□ is to be installed, should conduct and verify the installation.
- (9) G9SX-SM□ determines that motor stops when the standstill detection input voltage is predetermined value or less. According to the characteristic or load condition of motor, it may turn on safety detection outputs before motor stops completely. In that case, before operation, the qualified personnel should verify that risk of the rotation condition after output is acceptable.
- (10) Perform daily and 6-month inspections for the G9SX-SM□. Otherwise, the system may fail to work properly, resulting in serious injury.
- (11) Do not dismantle, repair, or modify G9SX-SM□. It may lead to loss of its safety functions.
- (12) Use only appropriate components or devices complying with relevant safety standards corresponding to the required level of safety categories. Conformity to requirements of safety category is determined as an entire system. It is recommended to consult a certification body regarding assessment of conformity to the required safety level.
- (13) OMRON shall not be responsible for conformity with any safety standards regarding to customer's entire system.
- (14) Disconnect G9SX-SM□ from power supply when wiring. Devices connected to G9SX-SM□ may operate unexpectedly.
- (15) Be cautious not to have your fingers caught when attaching terminal sockets to the plugs on G9SX-SM□.
- (16) Do not use in combustible gases or explosive gases.
- (17) Driving voltage of the motor is impressed to the standstill detection inputs. Connect overcurrent protective equipment; fuse, circuit-breaker etc., (3A Max.) and tighten the wirings by rated tightening torque to the standstill detection inputs.

## Precautions for Correct Use

- (1) Handle with care  
Do not drop G9SX-SM□ to the ground or expose to excessive vibration or mechanical shocks. G9SX-SM□ may be damaged and may not function properly.
- (2) Conditions of storage and usage  
Do not store or use in such conditions stated below.
  - 1) In direct sunlight
  - 2) At ambient temperatures out of the range of -10 to 55 °C
  - 3) At relative humidity out of the range of 25% to 85% or under such temperature change that causes condensation.
  - 4) In corrosive or combustible gases
  - 5) With vibration or mechanical shocks out of the rated values.
  - 6) Under splashing of water, oil, chemicals
  - 7) In the atmosphere containing dust, saline or metal powder.  
G9SX-SM□ may be damaged and may not function properly.
- (3) Mounting  
Mount G9SX to DIN rails with attachments (TYPE PFP-M, not incorporated to this product), not to drop out of rails by vibration etc. especially when the length of DIN railing is short compared to the widths of G9SX.  
Do not use G9SX-SM□ at altitudes over 1,000 meters.

- (4) Following spacing around G9SX should be available to apply rated current to outputs of G9SX and for enough ventilation and wiring:
  - 1) At least 25 mm beside side faces of G9SX.
  - 2) At least 50 mm above top face of G9SX and below bottom face of G9SX.

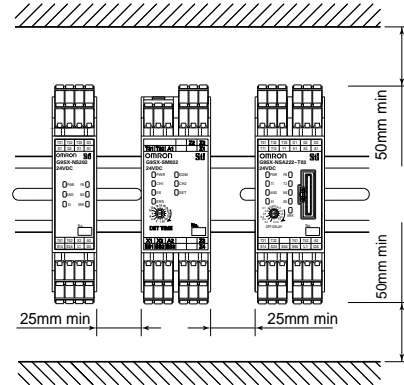

- (5) Wiring
  - 1) For model G9SX-SM□  
Use the following to wire to G9SX-SM□.
    - Solid wire: 0.2 to 2.5mm<sup>2</sup> AWG24 to AWG12
    - Stranded wire (Flexible wire): 0.2 to 2.5mm<sup>2</sup> AWG24 to AWG12
 Strip the cover of wire no longer than 7mm.
  - 2) For model G9SX-SM□-RT (with screw terminals)  
Tighten each screw with a specified torque of 0.5 to 0.6N·m, or the G9SX-SM□ may malfunction or generate heat.
- (6) Use cables with length less than 100m to connect to standstill detection Inputs and EDM input respectively.
- (7) Driving voltage of the motor is impressed to the standstill detection input and there is a possibility that a high level of noise is superimposed. The line of the standstill input must be separately installed from other signal lines.
- (8) Set the time duration of Standstill detection time to an appropriate value that does not cause the loss of safety function of system.
- (9) Tuning mode in User configuration is only for adjusting the Standstill determining time. In Tuning mode, auxiliary monitor output is enable however Safety Standstill detection outputs are not enabled. After the tuning is complete, be sure to change from Tuning mode to Monitoring mode for actual operation.
- (10) Safety standstill detection outputs are only for controlling a guard lock safety-door switch with mechanical lock. They can not be used as safety outputs to drive contactors, or to control a guard lock safety-door switch with solenoid lock.
- (11) To determine safety distance to hazards, take into account the delay of safety standstill detection outputs caused by the response time.
- (12) Start entire system after more than 5s have passed since applying supply voltage to all G9SXs in the system.
- (13) G9SX-SM□ may malfunction due to electro-magnetic disturbances. Be sure to connect the terminal A2 to ground.
- (14) This is a class A product. In residential areas it may cause radio interference, in which case the user may be required to take adequate measures to reduce interference.
- (15) Devices connected to G9SX-SM□ may operate unexpectedly. When replacing G9SX-SM□, disconnect it from power supply.
- (16) Adhesion of solvent such as alcohol, thinner, trichloroethane or gasoline on the product should be avoided. Such solvents make the marking on G9SX-SM□ illegible and cause deterioration of parts.
- (17) Connectable motor  
AC induction motors can be connected to the G9SX-SM□. Servo motors cannot be connected. When a motor with AC240V or more is used, connect neutral point of the power supply to earth.
- (18) G9SX-SM□ does not have motor fault detective function or motor protective function. For motor protection, use designated external protective devices.
- (19) For use with inverter  
The dynamic break setting time should be set to 30 seconds or shorter. Otherwise, the G9SX-SM□ may detect a disconnect fault of the wiring.  
Also in the following cases, the standstill detection function may not properly work even while the motor is in standstill.
  1. An inverter with a large output residual voltage is used, and the contactor connected in serial with the inverter is in the ON state.
  2. The inverter is executing the auto tuning function.
- (20) Operate the reset input more than 0.4 seconds immediately after the safety outputs are OFF.  
G9SX-SM□ does not accept the reset input from when the outputs are turned ON and until 0.4 seconds passes after the outputs are turned OFF.

# 1 Functions

Use the "Operation Preset switch" on the back side to select either Standard Configuration or User Configuration. The selected configuration mode is enabled at power-on.

- Normally, please use Standard Configuration which is set as factory default.
- If the Standstill determining time is found too long in the Standard Configuration mode, switch to User Configuration and adjust the Standstill determining time.

## ● Standard Configuration

When G9SX-SM detects that the standstill detection input voltage is 10mV or less, it will turn on safety detection outputs, determining the motor is in a standstill condition.

In Standard Configuration, any settings with the "Mode Preset switch" and both of the "Standstill Detection Time Preset switches" are disabled.

## ● User Configuration

When G9SX-SM detects that the standstill detection input voltage has been 100mV or less for a predetermined Standstill determining time or longer, or when G9SX-SM detects that the standstill detection input voltage has been 10mV or less, it will turn on safety standstill detection outputs, determining the motor is in a standstill condition.

In User Configuration, two modes are available: Tuning mode (TUN) and Monitoring mode (MON). Either can be selected by setting the "Mode Preset switch".

The selected mode is applied at power-on.

Mode name	Function	Operation
Tuning Mode	Use this mode to adjust the Standstill determining time. This mode is only for adjusting the Standstill determining time. (*1)	To preset the Standstill determining time, use the "DET TIME switch (the Standstill determining time Preset switch)" on the front side. Once the DET TIME setting is changed, the new setting immediately comes into effect on the system without having to perform a power cycle. When a standstill condition is detected, the Auxiliary Monitor output is turned on and the ES Indicator is lit, but Safety standstill detection outputs are NOT turned on.
Monitoring Mode	Use this mode in normal operation after the Standstill determining time is fixed.	In this mode, G9SX-SM operation depends on the "DET TIME switches", one each on the front side and the back side. The DET TIME setting values come into effect at power on.

\*1. If the optimal Standstill determining time is already known, the value can be applied to the Monitoring Mode, without having to use the Tuning Mode.

## ● Standard Configuration

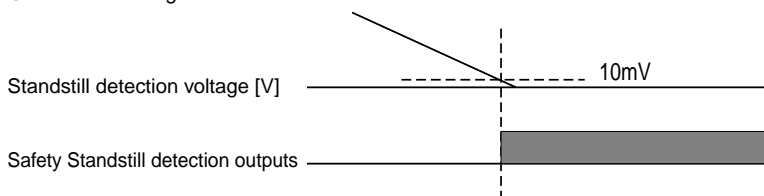

## ● User Configuration

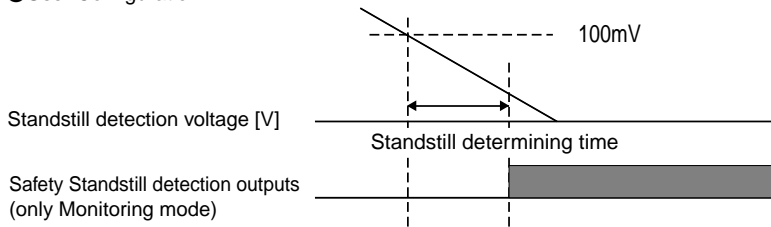

## 2 Appearance and Explanation of Each Parts

Type G9SX-SM032-□

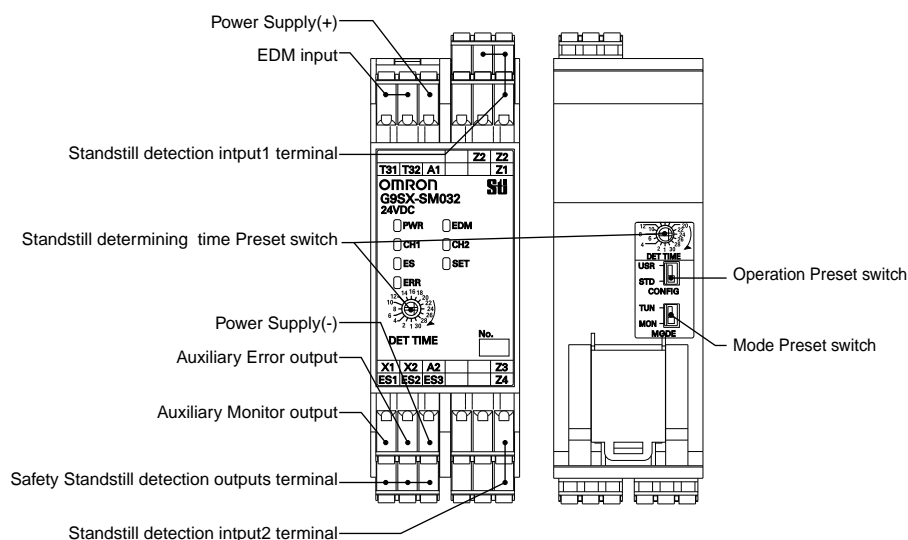

### LED Indicators

Marking	Color	Name	Function
PWR	Green	Power Supply Indicator	- Lights up while power is supplied.
EDM	Orange	EDM input Indicator	- Lights up while high signal is input to T32 - Blinks when error relating to EDM (External Device Monitor) input occurs. (*1)
CH1	Orange	Standstill detection input ch1 Indicator	- Lights up while the Standstill detection input voltage for Z1-Z2 is below the threshold voltage. - Blinks when an error relating to Standstill detection input ch1 occurs. (*1)
CH2	Orange	Standstill detection input ch2 Indicator	- Lights up while the Standstill detection input voltage for Z3-Z4 is below the threshold voltage. - Blinks when an error relating to Standstill detection input ch2 occurs. (*1)
ES	Orange	Safety standstill detection output Indicator	- Lights up while Safety standstill detection outputs (ES1, ES2, ES3) are in ON-state. - Blinks when an error relating to Safety standstill detection outputs occurs. (*1)
SET	Orange	Setting Indicator	- Depending on the status of Operation preset switch and Mode preset switch. See below for details. Standard Configuration: Turns off Tuning mode in User Configuration: Blinks Monitoring mode in User Configuration: Lights up - Blinks when an error relating the selected configuration mode occurs. (*1)
ERR	Red	Error Indicator	- Lights up or blinks depending on the occurring error (*1)

### Preset Switches

Change the value of the preset switches only when G9SX-SM□ is disconnected from the power supply. The states of the preset switches come into effect when the power supply to G9SX-SM□ turns on. (\*2)

Name	Function	State/Value (position of switch)
Configuration Preset Switch	Selects either Standard configuration or User configuration	STD (Standard configuration: default setting)/USR (User configuration)
Mode Preset Switch	Selects either Tuning mode or Monitoring mode in User configuration. (*3)	MON (Monitoring mode: default setting)/TUN (Tuning mode)
Standstill determining time Preset Switch	Presets the Standstill determining time in User Configuration (*4)	1/2/4/6/8/10/12/14/16/18/20/22/24/26/28/30 (default setting value) (*5)

Note:

\*1. See 8 Fault Detection for details.

\*2. In Tuning mode, changing of the "Standstill determining time Preset Switch" is immediately applied.

\*3. Safety standstill detection outputs do not turn ON during the Tuning mode, even when a standstill condition is detected.

\*4. Set both of the two Standstill determining time Preset Switches, one each on the front and back, to the same value.

\*5. See the illustration below for setting the "Standstill determining time Preset Switches". Make sure that the direction of cutting edge of preset switch is correctly pointed to the determining time value which must be set.

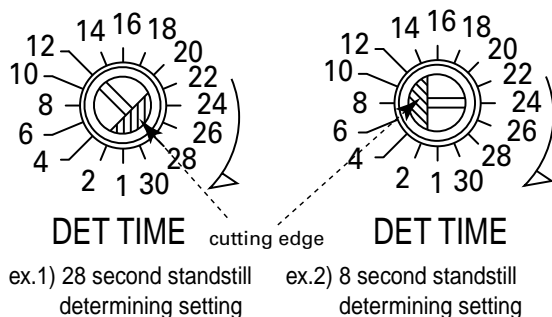

### 3 Internal Connection

Type G9SX-SM032-□

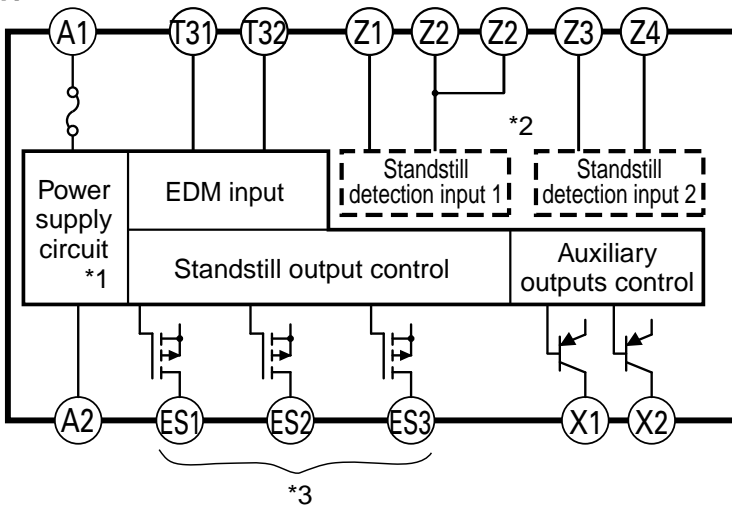

\*1 Internal power supply circuit is not isolated.

\*2 Standstill detection inputs are isolated respectively.

\*3 The Safety standstill detection outputs, ES1 - ES3, are internally redundant respectively.

### 4 Dimensions

Type G9SX-SM032-□

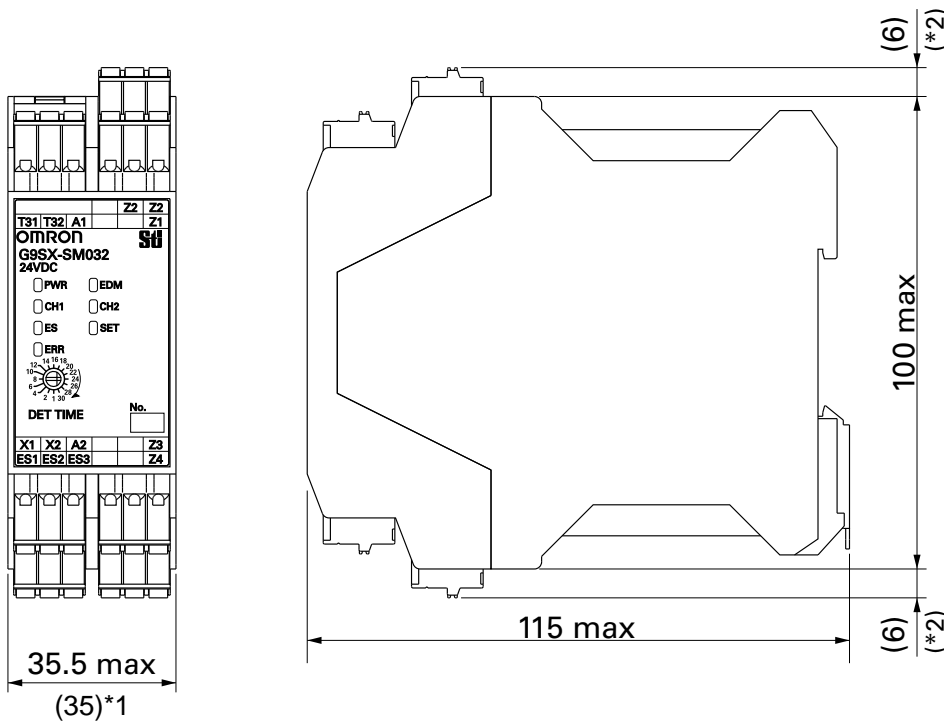

Note 1. Above outline drawing is for -RC terminal type.

\*1. Typical dimension.

\*2. For -RC terminal type only.

## 5 Ratings and Specifications

### Ratings

Item	TYPE G9SX-SM032-□	
Power input	Rated supply voltage	24VDC
	Operating voltage range	-15% to +10% of rated supply voltage
	Rated power consumption (*1)	4 W Max.
Inputs	Rated Input voltage	Standstill detection input (Z1-Z2/Z3-Z4) (*2) 480VAC max.(120Hz max.)(*3)
	Internal impedance	Standstill detection input : approx. 660kohm EDM input : approx. 2.8kohm (*4)
Outputs	Safety Standstill detection output (*5)	sourcing output(PNP) Load current: 300mA DC max. (*6)
	Auxiliary output	sourcing output(PNP) Load current: 100mA DC Max.

### Specifications and Performance

Item	TYPE G9SX-SM032-□
Over voltage category (IEC/EN 60664-1)	III
Response time (ON to OFF state)	50 ms Max.
Detection voltage (Standstill detection voltage)	Standard Configuration: 10mV Max. User Configuration: 100mV Max.
ON-state residual voltage	3.0 V Max. (Safety standstill detection outputs and Auxiliary outputs)
OFF-state leakage current	0.1 mA Max. (Safety standstill detection outputs and Auxiliary outputs)
Maximum cable length for standstill detection inputs and EDM input	100m Max. (Permissible impedance : 100ohm Max. and 10nF Max.)
Vibration resistance	Frequency: 10 to 55 to 10Hz, Amplitude: 0.375mm half amplitude (0.75mm double amplitude)
Mechanical shock resistance	300 m/s <sup>2</sup> (destruction) 100 m/s <sup>2</sup> (malfunction)
Ambient temperature	-10 to +55°C (No freezing or condensation)
Ambient humidity	25 to 85%RH
Degree of protection	Terminal block: IP20 Main body: IP40
Weight	Approx. 200 g

### Insulation specifications

Item	TYPE G9SX-SM032-□	
Insulation resistance	- Between standstill detection inputs (Z1,Z2 ⇔ Z3,Z4)	100Mohm Min. (500VDC megger)
	- Between Standstill detection input terminals connected together and Power supply input terminals and other input and output terminals connected together.	100Mohm Min. (500VDC megger)
	- Between all terminals without Standstill detection input terminals connected together and DIN rail.	100Mohm Min. (500VDC megger)
	- Between Standstill detection input terminals connected together and DIN rail.	100Mohm Min. (500VDC megger)
Dielectric strength	- Between standstill detection inputs (Z1,Z2 ⇔ Z3,Z4)	2000VAC for 1min
	- Between Standstill detection input terminals connected together and Power supply input terminals and other input and output terminals connected together.	2200VAC for 1min
	- Between all terminals without Standstill detection input terminals connected together and DIN rail.	500VAC for 1min
	- Between Standstill detection input terminals connected together and DIN rail.	2200VAC for 1min

#### Note:

- \*1. Power consumption of loads not included.
- \*2. Please input voltage between 2 phases to Z1-Z2 and Z3-Z4.
- \*3. When a motor with AC240V or more is used, connect neutral point of the power supply to earth.
- \*4. For EDM input, use devices with contacts capable of switching micro loads of 24VDC, 5mA.
- \*5. While Safety standstill detection outputs are in the ON state, signal sequence shown below is output continuously for diagnosis.  
When using the Safety standstill detection outputs as input signals to control devices (e.i. programmable controller), consider the off pulse below.

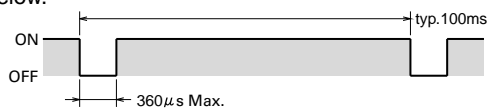

- \*6. The following derating is required when units are mounted side-by-side.  
- 0.2 A max. load current

# 6 Application Examples

G9SX-SM032(DC24V) <3-phase motor>

+ G9SX-AD322-T15(DC24V)

<Guard lock Safety-door switch + Safety limit switch 2ch input / manual reset>

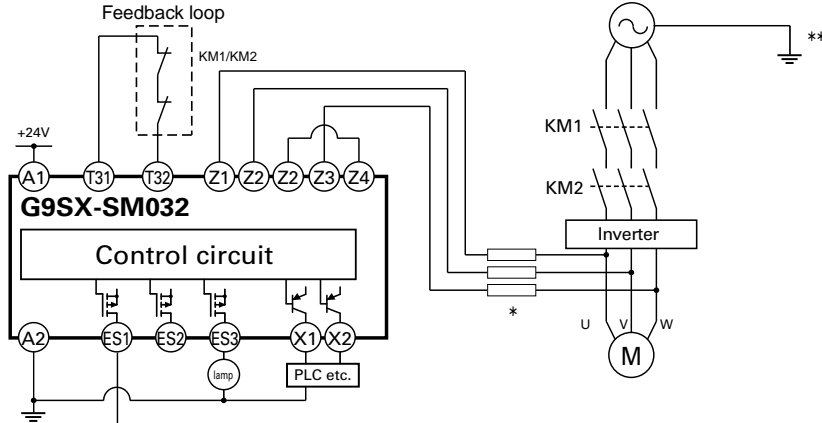

Note1: This example is corresponding to category 4 (Stop category 1). Refer to '7 Safety Category (EN ISO13849-1) for details.

\*For protecting the motor against short-circuit due to incorrect wiring, etc., apply overcurrent protective equipments; fuses, circuit-breaker, etc., with the ratings below.

Rated voltage: Greater than Standstill detection inputs (the voltage supplied to the motor)

Rated current: 3A max

\*\*When a motor with AC240V or more is used, connect neutral point of the power supply to earth.

Devices	
S1	: Guard lock Safety-door Switch
S2	: Safety Limit Switch
S3	: Stop signal
S4	: Reset Switch
S5	: Lock release switch
KM1, KM2	: Contactor
M	: 3-phase motor

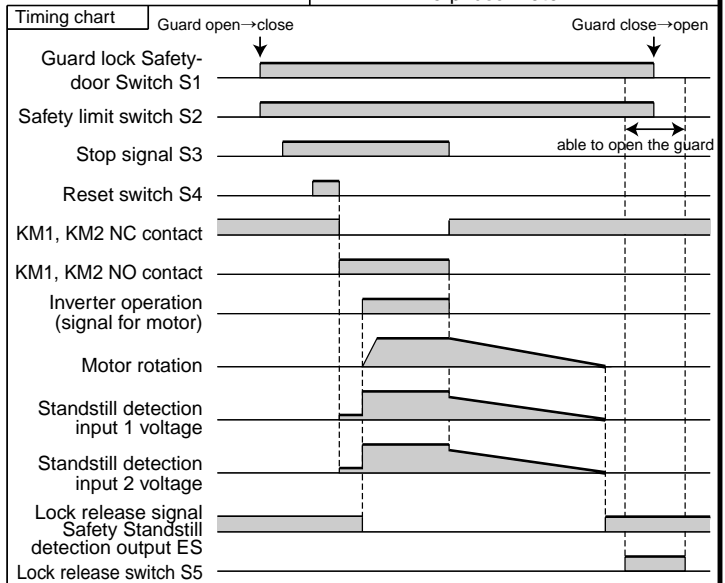
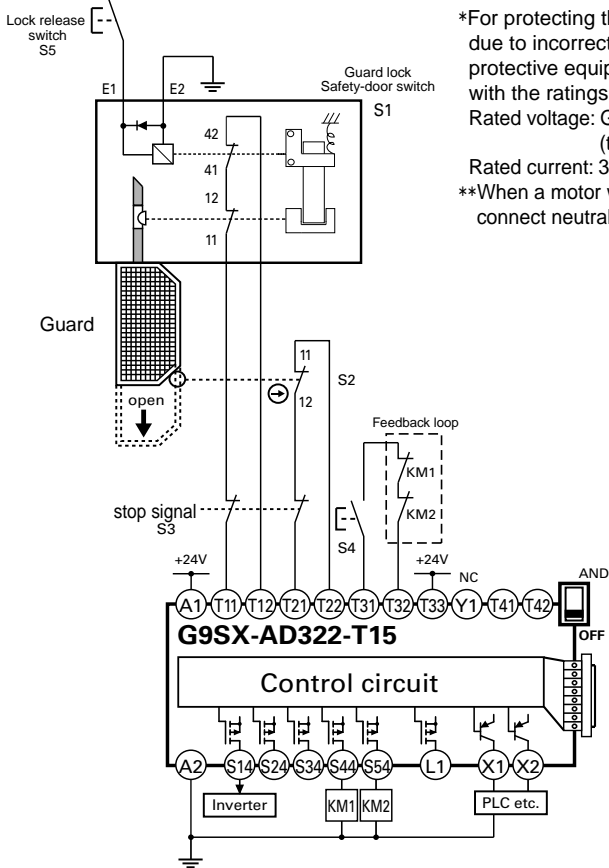

G9SX-SM032(DC24V) <3-phase motor with Star-Delta wiring>  
 + G9SX-BC202(DC24V)  
 <Guard lock Safety-door switch + Safety limit switch 2ch input / manual reset>

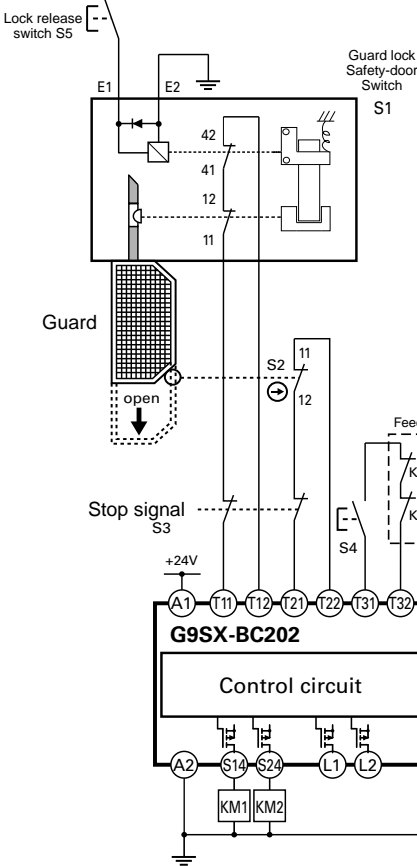
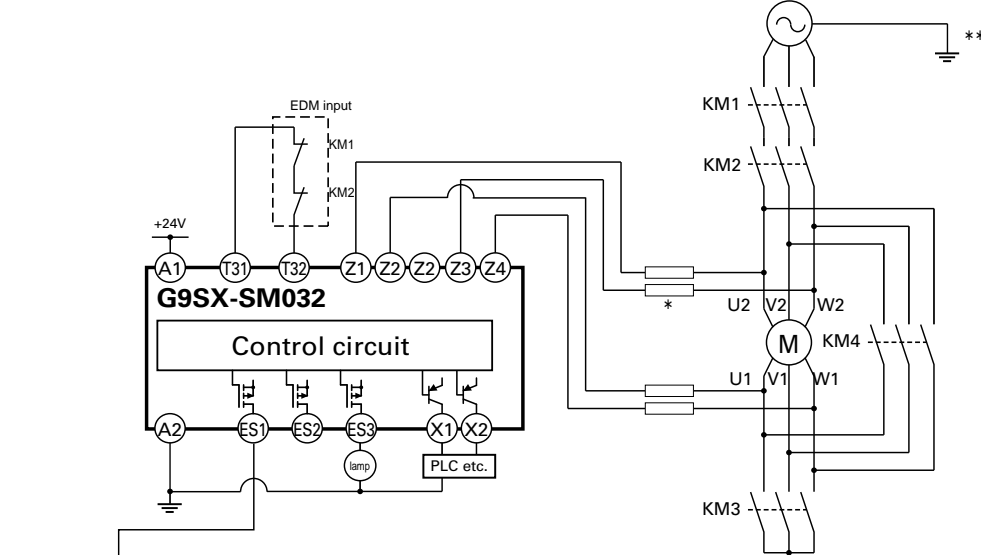

Note1: This example is corresponding to category 4 (Stop category 0)  
 Refer to '7 Safety Category (EN ISO13849-1) for details.

\* For protecting the motor against short-circuit due to incorrect wiring, etc., apply overcurrent protective equipments; fuses, circuit-breaker, etc., with the ratings below.  
 Rated voltage: Greater than Standstill detection inputs (the voltage supplied to the motor)  
 Rated current: 3A max  
 \*\*When a motor with AC240V or more is used, connect neutral point of the power supply to earth.

Devices	
S1	: Guard lock Safety-door Switch
S2	: Safety limit switch
S3	: Stop signal
S4	: Reset switch
S5	: Lock release switch
KM1, KM2	: Contactor
M	: 3-phase motor
KM3, KM4	: Contactor for star-delta starter

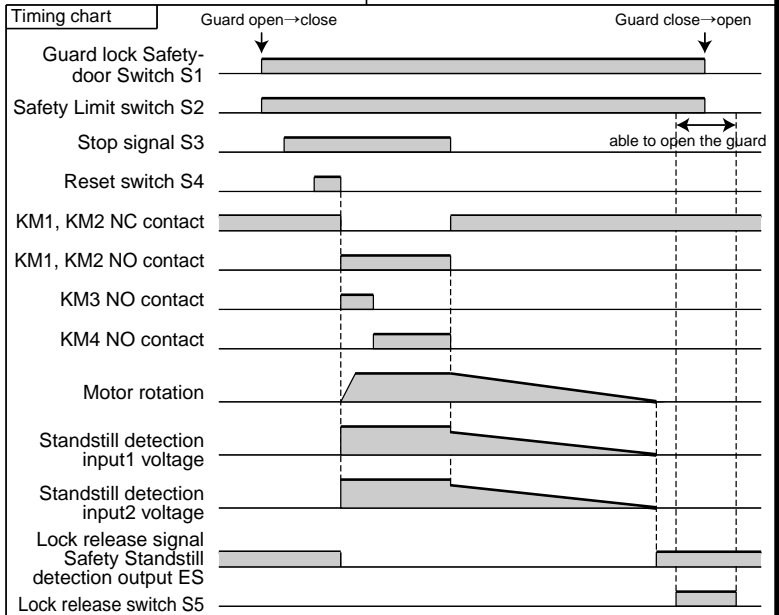



G9SX-SM032(DC24V) <3-phase motor>  
 + G9SX-BC202(DC24V) <Emergency stop switch 2ch input / manual reset>  
 + G9SX-GS226-T15(DC24V)  
 <Guard lock safety-door switch + Safety limit switch 2ch input / manual reset>

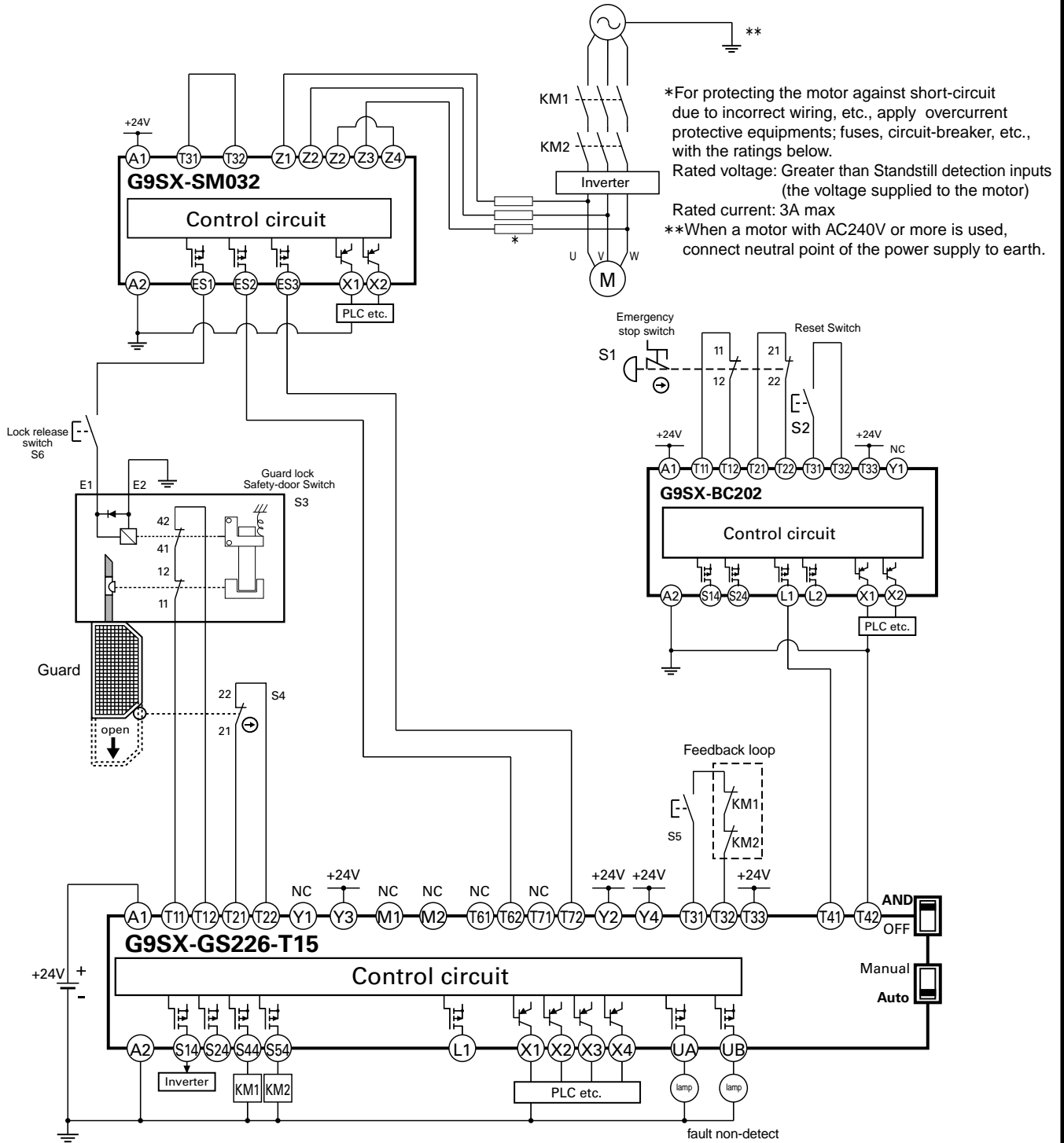

\*For protecting the motor against short-circuit due to incorrect wiring, etc., apply overcurrent protective equipments; fuses, circuit-breaker, etc., with the ratings below.  
 Rated voltage: Greater than Standstill detection inputs (the voltage supplied to the motor)  
 Rated current: 3A max  
 \*\*When a motor with AC240V or more is used, connect neutral point of the power supply to earth.

Note1: This example is corresponding to category 3 (Stop category 2). Refer to '7 Safety Category(EN ISO13849-1) for details.  
 Note2: Power for the inverter is cut when the motor rotation is detected in this system with a guard open. Its response time is an accumulation of G9SX-SM and G9SX-GS. Determine a safety distance to hazards in view of this response time.

Devices	
S1	: Emergency switch
S2	: Reset switch
S3	: Guard lock Safety-door switch
S4	: Safety limit switch
S5	: Reset switch
S6	: Lock release switch
KM1, KM2	: Contactor
M	: 3-phase motor

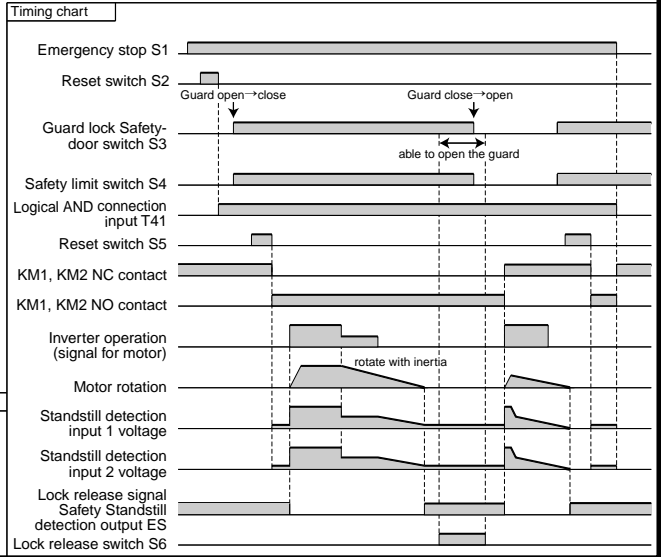

# Wiring of inputs and outputs

Signal Name	Terminal Name	Description of operation	Wiring
Power supply input	A1, A2	Connect the power source to the A1 and A2 terminals.	Connect the power supply plus to the A1 terminal. Connect the power supply minus to the A2 terminal.
Standstill detection input 1	Z1, Z2	To turn on the Safety standstill detection outputs, both Standstill detection inputs must be below the threshold voltage. Otherwise, Safety standstill detection outputs will NOT be turned ON. When the wiring between the motor and G9SX-SM□ breaks, G9SX-SM□ detects it as failure of the wiring or continues to operated as motor is rotating, regardless of the status of motor. Thus the breakage of wiring does not lead to a dangerous situation.	Connect Z1 and Z2 to the motor lines respectively.
Standstill detection input 2	Z3, Z4		Connect Z3 and Z4 to the motor lines respectively.
EDM input	T31, T32	To turn on Safety standstill detection outputs, ON-state signals should be input to T32. Otherwise, Safety standstill detection outputs will not be turned ON.	External device is not monitored.
			External device is monitored.
Safety Standstill detection output	ES1, ES2, ES3	Turns ON/OFF according to the state of standstill detection inputs and EDM input.	Keep these outputs Open when NOT used.
Auxiliary Monitor output	X1	Outputs a signal of the same logic as Safety standstill detection outputs	Keep these outputs Open when NOT used.
Auxiliary Error output	X2	Turns on when the error indicator is blinking or lit.	Keep these outputs Open when NOT used.

\* For protecting the motor against short-circuit due to incorrect wiring, etc., apply overcurrent protective equipment: fuses, circuit-breaker, etc., with the ratings below.  
 Rated voltage: Greater than standstill detection inputs (voltage supplied to the motor)  
 Rated current: 3A max.

## ● Reference data

Standstill detection input voltage in motor rotate frequency

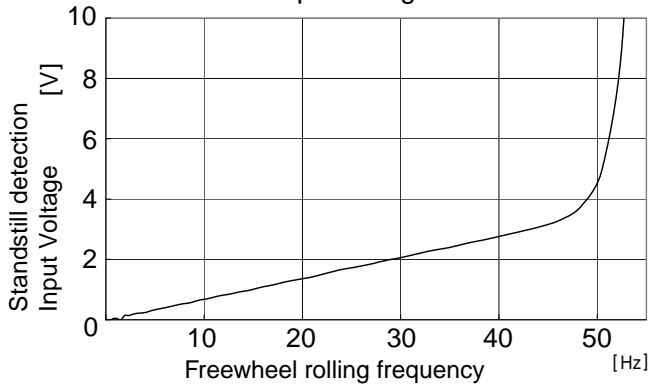

Note1. This graph shows a typical data of a 3-phase motor, and NOT guaranteed performance. Performance will depend on characteristics of the motor.

## ● Terminal arrangement and LED indicators

TYPE G9SX-SM032-□

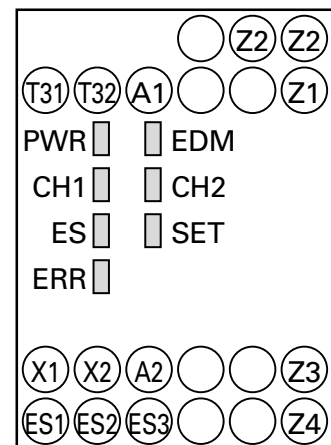

## 7 Performance Level and Safety category of EN ISO13849-1

The G9SX-SM□ can be used for PL=e and Category 4 required by EN ISO 13849-1 European standard.

Refer to the following link for the Safety-related characteristic data:

[http://www.fa.omron.co.jp/safety\\_6en/](http://www.fa.omron.co.jp/safety_6en/)

This does NOT mean that G9SX-SM can always be used for required category under all the similar conditions and situations.

Conformity to the categories must be assessed as a whole system.

When using G9SX-SM for safety categories, be sure to confirm the conformity as a whole system.









For conformity to Safety Category 4, please check the following points;

- 1) Connect a fuse to each of the Standstill detection input lines.
- 2) Provide signals of different phases for the Standstill detection inputs (Z1-Z2, Z3-Z4).
- 3) Connect Guard lock Safety-door switches to any one of Safety Standstill detection outputs: ES1, ES2 or ES3.
- 4) Input the signal through a NC contact of the contactor to EDM input T31-T32. (Refer to '6. Application Examples')
- 5) Be sure to connect A2 to ground.



## 8 Fault Detection

When G9SX-SM detects a fault, ERR indicator and/or other indicators light up or blink to show the information of the fault.

Check and take needed measures referring to the following table, and then apply supply voltage to G9SX-SM.

ERR indicator	Other indicators	Faults	Expected causes	Checking points and measures to take
 Blink	—	Fault by electro-magnetic disturbance or of internal circuits.	<ol style="list-style-type: none"> <li>1) Excessive electro-magnetic disturbance</li> <li>2) Failures of the parts of internal circuits</li> </ol>	<ol style="list-style-type: none"> <li>1) Check the disturbance level around G9SX-SM and its related system.</li> <li>2) Replace with a new product.</li> </ol>
 Light up	 CH1 Blink	Faults involved with Standstill detection input 1	<ol style="list-style-type: none"> <li>1) Failures involving the wiring of Standstill detection input 1</li> <li>2) Inverter dynamic brake setting</li> <li>3) Failures of the parts of the circuits of Standstill detection input 1</li> </ol>	<ol style="list-style-type: none"> <li>1) Check the wiring to Z1 and Z2.</li> <li>2) Set the brake time at less than 30 seconds</li> <li>3) Replace with a new product.</li> </ol>
	 CH2 Blink	Faults involved with Standstill detection input 2	<ol style="list-style-type: none"> <li>1) Failures involving the wiring of Standstill detection input 2</li> <li>2) Inverter dynamic brake setting</li> <li>3) Failures of the parts of the circuits of Standstill detection input 2</li> </ol>	<ol style="list-style-type: none"> <li>1) Check the wiring to Z3 and Z4.</li> <li>2) Set the brake time at less than 30 seconds</li> <li>3) Replace with a new product.</li> </ol>
	 CH1 and CH2 Blink at once	Faults involved with Standstill detection input	<ol style="list-style-type: none"> <li>1) Frequency of standstill detection input is out of range.</li> </ol>	<ol style="list-style-type: none"> <li>1) Confirm the operation frequency of the motor is 120Hz or less.</li> </ol>
	 EDM Blink	Faults involved with EDM input	<ol style="list-style-type: none"> <li>1) Failures involving the wiring of EDM input.</li> <li>2) Excessive electro-magnetic disturbance</li> <li>3) Failures of the parts of the circuits of EDM input</li> </ol>	<ol style="list-style-type: none"> <li>1) Check the wiring to T31 and T32</li> <li>2) Separately wire to T31 and T32 from the power line etc., of the inverter.</li> <li>3) Replace with a new product.</li> </ol>
	 ES Blink	Faults involved with Safety Standstill detection outputs	<ol style="list-style-type: none"> <li>1) Failures involving the wiring of Safety Standstill detection outputs</li> <li>2) Excessive electro-magnetic disturbance</li> <li>3) Failures of the parts of the circuits of Safety Standstill detection outputs</li> <li>4) Impermissible high ambient temperature</li> </ol>	<ol style="list-style-type: none"> <li>1) Check the wiring to ES1, ES2 and ES3.</li> <li>2) Separately wire to ES1, ES2 and ES3 from the power line etc. of the inverter.</li> <li>3) Replace with a new product.</li> <li>4) Check the ambient temperature and spacing around G9SX-SM.</li> </ol>
	 SET Blink	Faults involved with Operation mode settings	<ol style="list-style-type: none"> <li>1) Incorrect set values of Standstill detection time preset switches.</li> <li>2) Failures of the parts of the circuits of mode settings.</li> </ol>	<ol style="list-style-type: none"> <li>1) Confirm the set values of the two of Standstill detection time preset switches.</li> <li>2) Replace with a new product.</li> </ol>
	 The All (without PWR) indicators Blink	Supply voltage outside the rated value	<ol style="list-style-type: none"> <li>1) Supply voltage outside the rated value</li> </ol>	<ol style="list-style-type: none"> <li>1) Check the supply voltage to G9SX units.</li> </ol>

If any other indicator than ERR Indicator blinks, check and take needed actions referring to the following table.

ERR indicator	The other indicators	Conditions	Expected causes of the faults	Expected causes of the faults
 Light off	 SET Blink	Tuning mode operation	Operating mode is in Tuning mode of User configuration.	Check if the Operation preset switch and the Mode preset switch on the back side are properly set. In the User Configuration mode, Safety standstill detection outputs will NOT be turned on.

# OMRON

OMRON Corporation (Manufacturer)  
Shiokoji Horikawa, Shimogyo-ku, Kyoto, 600-8530  
JAPAN

OMRON EUROPE B.V. (Importer in EU)  
Wegalaan 67-69, NL-2132 JD Hoofddorp  
THE NETHERLANDS  
PHONE: 31-2356-81-300 FAX: 31-2356-81-388

OMRON ELECTRONICS LLC  
2895 Greenspoint Parkway, Suite 200  
Hoffman Estates, IL 60169 U.S.A.  
PHONE: 1-847-843-7900 FAX: 1-847-843-7787

OMRON ASIA PACIFIC PTE. LTD.  
438A Alexandra Road # 05-05/08,  
Alexandra Technopark Singapore 119967  
SINGAPORE  
PHONE: 65-6-835-3011 FAX: 65-6-835-2711

OMRON (CHINA) CO., LTD.  
Room 2211, Bank of China Tower, 200 Yin Cheng Zhong Road,  
PuDong New Area, Shanghai, 200120, China  
PHONE 86-21-5037-2222 FAX 86-21-5037-2200

Note: Specifications subject to change without notice.