

NT31-ST123 (B) -EV□
NT31C-ST143 (B) -EV□
Programmable Terminal



INSTRUCTION SHEET

Thank you for purchasing this OMRON product. Please read this instruction sheet and thoroughly familiarize yourself with the functions and characteristics of the product before use. Please retain this sheet for future reference.

For more information on specifications and usage, please refer to each PT & Support Tool manual.

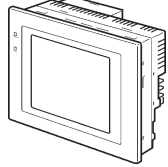

OMRON Corporation

©OMRON Corporation 2006 All Rights Reserved 7461610-5A

Safety Precautions

■ **Definition of Precautionary Information**

WARNING Indicates a potentially hazardous situation which, if not avoided, could result in death or serious injury.

Warnings
WARNING Do not attempt to take the Unit apart and do not touch any internal parts while the power is being supplied. Doing either of these may result in electric shock.

- Always ensure that the personnel in charge confirm that installation, inspection, and maintenance were properly performed for the PT. "Personnel in charge" refers to individuals qualified and responsible for ensuring safety during machine design, installation, operation, maintenance, and disposal.
- Ensure that installation and post-installation checks are performed by personnel in charge who possess a thorough understanding of the machinery to be installed.
- Do not use the input functions of the PT, such as the function switches or switches on the touch panel, in applications that involve human life, in applications that may result in serious injury, or for emergency stop switches.
- Do not attempt to disassemble, repair, or modify the PT. Doing so may impair the safety functions.

Notice

- When unpacking the Units, check carefully for any external scratches or other damage. Also, shake the Units gently and check for any abnormal sound.
- Turn OFF the power supply to the PT before mounting or dismounting I/F Units such as a Memory Unit. Correctly mount the I/F Units according to the User's Manual of the PT.
- Do not touch PCBs with bare hands. Discharge static electricity accumulated in your body in advance.
- The mounting panel must be between 1.6 and 4.8 mm thick. Tighten the Mounting Brackets evenly to a torque of between 0.5 and 0.6 N•m to maintain water and dust resistance. Make sure the panel is not dirty or warped and that it is strong enough to hold the Units.
- Do not let metal particles enter the Units when preparing the panel.
- Double-check all the wiring before turning ON the power supply.
- Do not connect an AC power supply to the DC power supply terminals.
- Do not perform a dielectric voltage test.

- Use a DC power supply with minimal fluctuation voltage.
 Rated power supply voltage: 24 VDC
 (Allowable range: 20.4 to 26.4 VDC)
 Capacity: 15 W min.
- Use a twisted-pair cable of at least 2 mm² to connect to the power supply terminals and always use an M3.5 crimp terminal. Tighten the terminal screws to 0.8 N•m. Make sure the screws are properly tightened.
- Turn OFF the power supply to the NT31/NT31C before connecting or disconnecting cables between devices.
- Always tighten the connector screws after connecting communications cables.
- The maximum pull load for cables is 30 N. Do not apply loads greater than this.
- Confirm the safety of the system before turning ON or OFF the power supply or pressing the reset switch.
- Start actual system application only after sufficiently checking screen data and the operation of the program in the PC (host).
- When using the Programming Console functions, confirm system safety and then perform the following operations:
 - Changing monitor data
 - Changing operation modes
 - Forced setting or resetting
 - Changing present values or set values

- Do not press the touch switch with a force greater than 30 N.
- Do not accidentally press touch switches when the Backlight is not lit or when the display does not appear. Confirm the safety of the system before pressing touch switches.
- When transferring data in screen data units, also transfer data associated with changes in the memory tables or direct connection.
- To assure system safety, incorporate a program that periodically calls PT operation bits from the host side to check that the PT is properly operating.
- Dispose of any battery that has been dropped on the floor or otherwise subjected to excessive shock. Batteries that have been subjected to shock may leak if they are used.
- Dispose of the product and batteries according to local ordinances as they apply. Have qualified specialists properly dispose of used batteries as industrial waste.
- The backlight in the PT contains mercury. Do not dispose of the PT together with other waste to be sent to a disposal site. Dispose of the PT according to local ordinances as they apply.
- The whole system may stop depending on how the power supply is turned ON or OFF. Turn ON or OFF the power supply according to the specified procedure.
- An after-image will remain if the same patterns are displayed continuously for extended periods of time (e.g., 24 hours). Use the screen saver or periodically change the display to prevent after-images.
- Signals from the touch switches may not be input if the switches are pressed consecutively at high speed. Confirm each input before proceeding to the next one.
- To ensure greater safety for numeric inputs, use the upper/lower limit setting function.
- Do not use benzene, paint thinner, or other volatile solvents, and do not use chemically treated cloths.
- Confirm that the current capacity of the connected device is 250 mA or less before using the 5V power supply from pin 6 of the serial port A. The 5V output of the NT31/NT31C is 250 mA max. at 5 V ±5%.



廢電池請回收

■ **Precautions for Correct Use**

- Do not install the Unit in the following places:
 - Locations subject to direct sunlight
 - Locations subject to temperatures or humidity outside the range specified in the specifications
 - Locations subject to condensation as the result of severe changes in temperature
 - Locations subject to corrosive or flammable gases
 - Locations subject to dust (especially iron dust) or salts
 - Locations subject to exposure to water, oil, or chemicals
 - Locations subject to shock or vibration

- Take appropriate and sufficient countermeasures when installing systems in the following locations:
 - Locations subject to static electricity or other forms of noise
 - Locations subject to strong electromagnetic fields
 - Locations subject to possible exposure to radioactivity
 - Locations close to power supplies

■ **Compliance with EC Directives**

- This product is EMC compliant when assembled in a complete PLC system of the specified PLC Series. Refer to the applicable manual for grounding, cable selection, and any other conditions for EMC compliance.
- NT31 User's Manual (Cat. No. V062)

- This is a class A product. It may cause radio interference in residential areas, in which case the user may be required to take adequate measures to reduce interference.

■ **Checking of Accessories**

- Confirm that the NT31-ST123 (B)-EV□ or NT31C-ST143 (B)-EV□ (referred to as "NT31/NT31C") is supplied with the following parts.
- Mounting Brackets: 6 sets

1. Nomenclature and Functions

The front and rear views of the NT31/NT31C are shown below. Check the names and functions.

■ **Front Side**

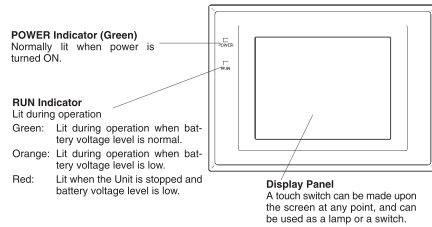

■ **Rear Side**

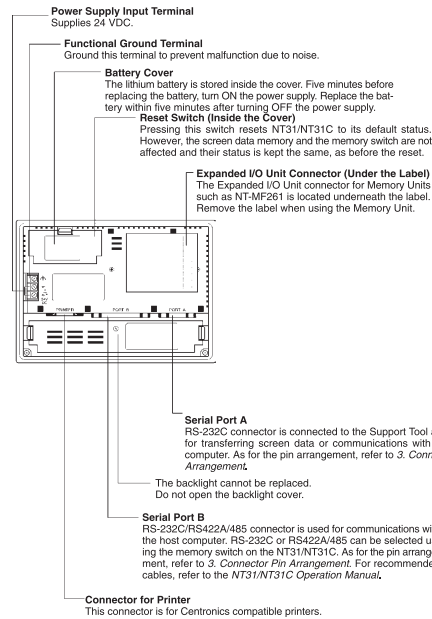

2. External Dimensions (When NT-MF261 Memory Unit is Mounted)

■ **Front Side**

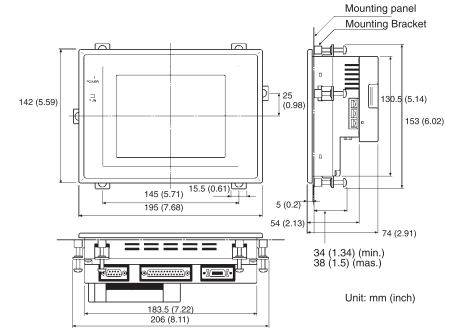

■ **Rear Side**

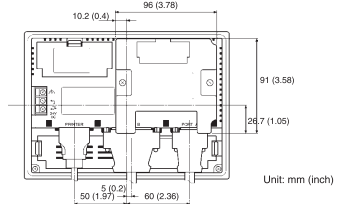

3. Connector Pin Arrangement

■ **Connectors for Printer**

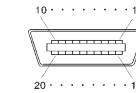

Pin No.	Signal name
1, 6, 13, 15, 18, 20	GND Signal Ground
2, 7, 14, 19	- Not used
3	PD5 Send Data 5
4	PD4 Send Data 4
5	PD3 Send Data 3
8	PD0 Send Data 0
9	STROB Strobe Signal
10	BUSY Busy
11	PD7 Send Data 7
12	PD6 Send Data 6
16	PD2 Send Data 2
17	PD1 Send Data 1

■ **Serial Port A Connector**

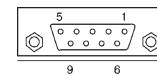

Pin No.	Signal name
1	- Not used
2	SD Send Data
3	RD Receive Data
4	RS Request to Send
5	CS Clear to Send
6	+5V +5 V output (250 mA max.)
7	- Not used
8	- Not used
9	SG Signal Ground

Serial Port B Connector

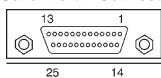

Pin No.		Signal name
1, 6, 8, 12, 13, 14, 17, 18, 19, 20, 21, 22, 25	—	Not used
2	SD	Send Data
3	RD	Receive Data
4	RS	RS Control Output
5	CS	CS Control Output
7	SG	Signal Ground
9	TRM	Terminating Resistance
10	RDB	RS-422A Receive Data (+)
11	SDB	RS-422A Send Data (+)
15	SDA	RS-422A Send Data (-)
16	RDA	RS-422A Receive Data (-)
23	RSB	RS Control Output (+)
24	RSA	RS Control Output (-)

Note. The terminating resistance can be connected by short-circuiting the TRM terminal (Pin 9) and RDB (Pin 10).

Wiring methods of the Connection Cables to the PLC vary depending on the PLC connector specifications.

For details on the Connection Cables, refer to the *NT31/NT31C Operation Manual*.

Power Supply Terminal Block



Crimp Terminals

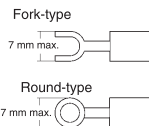

Recommended Crimp-style Terminals (For 24-VDC Input)

Manufacturer	Fork-type	Round-type	Conforming wire (twisted)
Japan Solderless Terminal MFG	2-YS3A	2-3.5	2.0 to 2.63 mm ²
Fuji Terminals	2-YAS3.5	V2-S3.5	
Nichifu Terminals	2Y-3.5	2-3.5	

Grounding

The NT31/NT31C has a functional ground terminal (⚡). Carry out wiring under the following conditions.

1. In cases where there is a potential difference between the grounds of the NT31/NT31C and the host, ground as shown in the following figure. If there is some distance between the NT31/NT31C and host and grounding at a single point is difficult, do not connect the functional ground terminal (⚡) of the NT31/NT31C.

2. If the NT31/NT31C is installed in the same panel as equipment that generates noise, such as a motor or inverter, do not ground the functional ground terminal (⚡) of the NT31/NT31C.

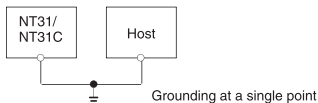

Note. Carry out grounding correctly in order to prevent operating errors due to noise.

4. Installation in a Panel

The NT31/NT31C is normally used installed on a flat surface in an operation panel. Use a Type I Enclosure for the operation panel. Attach the PT using the following procedure:

1. Create an opening in the panel.
Panel thickness: 1.6 to 4.8 mm

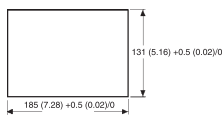

2. Install the NT31/NT31C from the front of the panel.

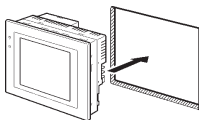

3. With the provided Mounting Brackets, secure the NT31/NT31C to the panel. Tighten them evenly to the specified torque. Excessive tightening or insufficient tightening may deform the front sheet. To maintain water-resistant performance, the tightening torque must be 0.5 to 0.6 N•m (4.4 to 5.3 lb•in).

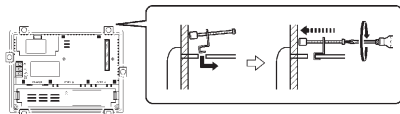

5. Connection Cables

Connection of Support Tool and Host

Connection Cables (sold separately) are required for connecting the Support Tool to the NT31/NT31C for image data transfer or for connecting the Host. For details on the Connection Cables, refer to the *NT31/NT31C Operation Manual*.

Connection to Printer

Screens displayed on the NT31/NT31C, its alarm history, and screen display history can be printed out using a printer. Use the following cables (sold separately) to connect to the printer. Use a printer equivalent to the ESC/P 24-J83C or ESC/P 24-J82 printer manufactured by Epson, PCL5 Printer manufactured by HP, or a printer that allows PC-PR201H to be emulated.

NT-CNT121 (Cable length: 1.5 m, manufactured by OMRON)
PC-9901N-19 (Cable length: 1.5 m, manufactured by NEC)



Connection to Bar Code Reader

Text string data can be input from a bar code reader connected to the serial port A on the NT31/NT31C. For details on the Connection Cables, refer to the *NT31/NT31C Operation Manual*.

6. Calendar, Clock, and Memory Switch Setting

The calendar and clock are set to correct date and time when the product is shipped. Set the memory switch according to the application by referring to the *NT31/NT31C Operation Manual* before touching components.

7. Changing the System Program

Use the following procedure to change the system program.

- 1, 2, 3... 1. While pressing the touch switch on the top left corner of the NT31/NT31C, turn ON the power supply. The system installer will start up. Execute "System Program Download."
2. Using the system installer on the personal computer side, install a new system program.
3. Once the system program is properly downloaded, press the "System Program Start" switch.

Note. Use the system installer included with NTST version 4.80 or later. System programs for NT31/31C-V2 or earlier cannot be transferred to a NT31/31C-V3 PT.

Operating Precautions

WARNING Do not use an input function such as the touch switch of a PT in places where they may endanger human lives or cause serious damage. Also, do not use an input function such as the touch switch of a PT as an emergency switch.

You must allow sufficient leeway in ratings and performance and provide proper fail-safe and other safety measures when using the Unit in any of the following applications. Be sure also to consult with your OMRON representative before actually attempting any of these applications.

1. Applications under conditions or environments not specified in user manuals.
2. Applications for nuclear reactor control, train facilities, aviation facilities, motorized vehicles, furnaces, medical equipment, amusement equipment, and safety equipment.
3. Applications strongly related to human life or property, particularly those requiring safety.

SUITABILITY FOR USE

OMRON shall not be responsible for conformity with any standards, codes, or regulations that apply to the combination of products in the customer's application or use of the products.

Take all necessary steps to determine the suitability of the product for the system, machines, and equipment with which it will be used. Please know and observe all prohibitions of use applicable to the products. NEVER USE THE PRODUCTS FOR AN APPLICATION INVOLVING SERIOUS RISK TO LIFE OR PROPERTY WITHOUT ENSURING THAT THE SYSTEM AS A WHOLE HAS BEEN DESIGNED TO ADDRESS THE RISKS, AND THAT THE OMRON PRODUCTS ARE PROPERLY RATED AND INSTALLED FOR THE INTENDED USE WITHIN THE OVERALL EQUIPMENT OR SYSTEM. See also product catalogs for Warranty and Limitations of Liability.

Local support office:

OMRON

OMRON Corporation
Industrial Automation Company

Control Devices Division H.Q.
HMI Devices Department
Shiozaki Horikawa, Shimogyo-ku,
Kyoto, 600-8530 Japan
Tel: (81) 75-344-7145
Fax: (81) 75-344-7149

Regional Headquarters

OMRON EUROPE B.V.
Wegalaan 67-69,
NL-2132 JD Hoofddorp
The Netherlands
Tel: (31)2356-81-300
Fax: (31)2356-81-388

OMRON ELECTRONICS LLC
One Commerce Drive Schaumburg,
IL 60173-5302 U.S.A.
Tel: (1) 847-843-7900
Fax: (1) 847-843-7787
OMRON ASIA PACIFIC PTE. LTD.
No. 438A Alexandra Road # 05-05/08
(Lobby 2), Alexandra Technopark,
Singapore 119967
Tel: (65) 6835-3011
Fax: (65) 6835-2711

OMRON (CHINA) CO., LTD.
Room 2211, Bank of China Tower,
200 Yin Cheng Zhong Road,
Pu Dong New Area, Shanghai,
200120, China
Tel: (86) 21-5037-2222
Fax: (86) 21-5037-2220

Note: Specifications subject to change without notice.
Printed in China