

Realized High-Speed, High-Precision, and High-Efficiency in AOI, Omron Proprietary Imaging Technique Combines Both Speed and Accuracy



Working together with our customers to create a better manufacturing environment

The technological evolution of the market has made manufacturing demands more complex and diverse, with higher quality requirements. In parallel, labor shortages are only adding to these challenges.

There is an urgent need to not only purchase new manufacturing equipment and improve performance, but also develop and train a skilled workforce able to support production.

In order to respond to these trends, Omron Inspection Systems Division is committed to:

- Zero defect products through reliable, high-precision inspection
- Minimizing programming time and skill through AI and quantitative inspection
- Maximizing good-quality throughput to prevent defects through the utilization of accurate quality data from inspection equipment alongside manufacturing data

Trends of manufacturing environment

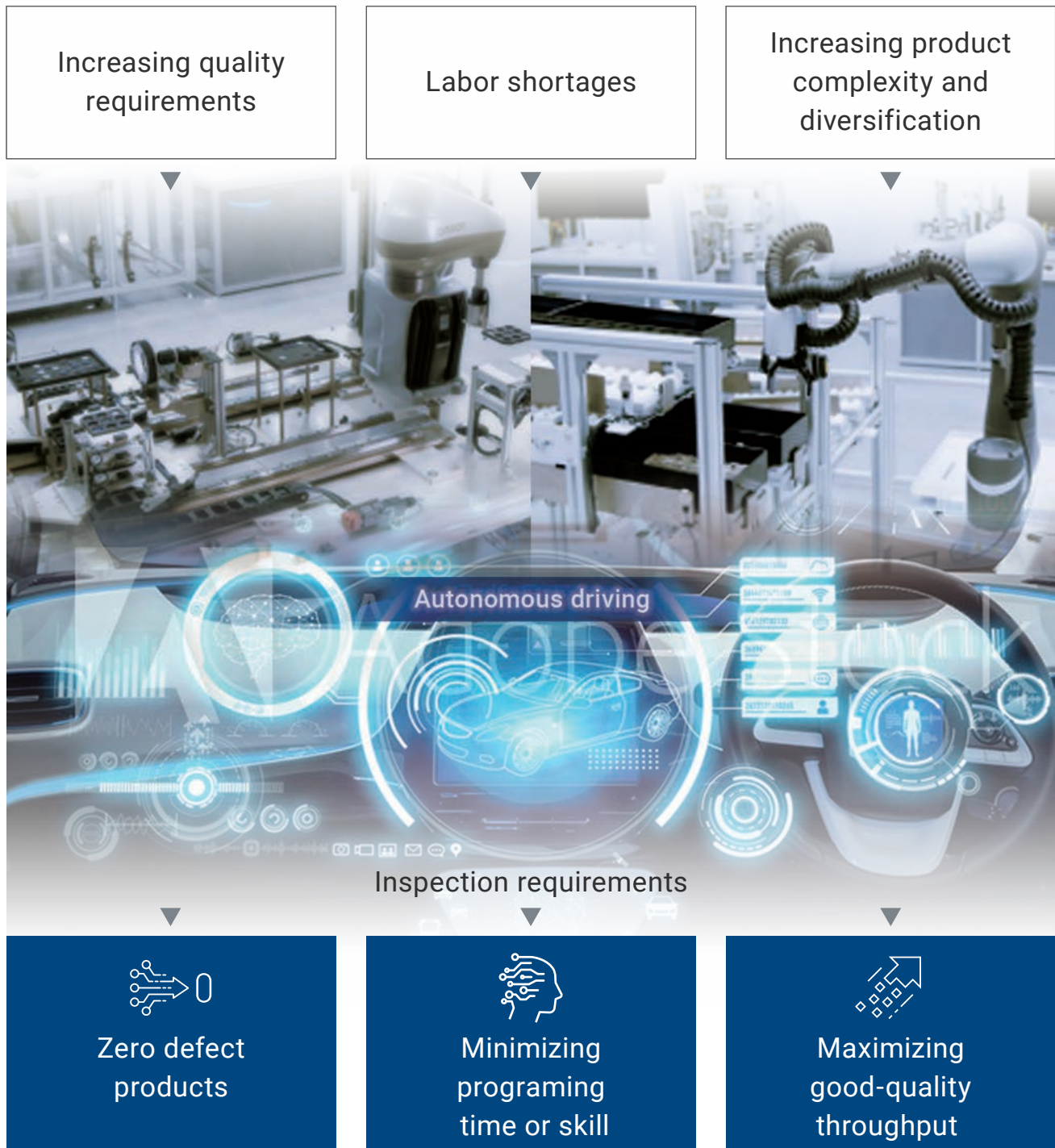

Omron's unique technology achieves the inspection requirements

Imaging technology
MDMC*1+MPS*2

High-precision solder shape reconstruction

Quantitative inspection based on international standards

AI inspection logic

M2M*3 system

Machine monitoring and predictive maintenance

VT-S1080-V2.0/S1040-V2.0/Z600-V2.0

*1. Multi Direction Multi Color
 *2. Micro Phase Shift
 *3. Machine to Machine

Remove takt time bottlenecks and reduce operator related steps and man-hour related inspections.

Faster

With greater accuracy

12M → 25M

CXP-12*5

AI

Applied with high-pixel camera, high viewing angle x high-speed communication
150%*4 decrease in inspection takt time compared to conventional type

Expanded AI coverage
Higher precision and skill-less inspection

*4: VT-S10 Series ratio*5 on our verification board is CoaXPress 2.0. An interface standard that enables high-speed transmission of large amounts of data.
 *5: Compared to our VT-S10 series-based verification substrates.

High-precision solder shape reconstruction helps achieve zero defect products



The combination of Omron's own patented technologies achieves highly robust*⁶ and reliable inspection performance.

*6: Excellent filtering of noise that effects the judgement of inspection results such as shadows, secondary reflections, abnormal defect shapes and other uncertain factors.

| Latest camera technology | Phase shift+ MPS* ⁹ | MDMC* ¹⁰ illumination |
|---------------------------------------------------------------------------------------------------------------------------------------------------------------------------------------------------------------------------------------------------------------------------------------------------------------------------------------------------------------------------------------------------------------------------------------------------------------------------------------------|------------------------------------------------------------------------------------------------------------------------------------------------------------------------------------------------------------------------------------------------------------------------------------------------|-----------------------------------------------------------------------------------------------------------------------------------------------------------------------------------------------------------------------------------------------------------------------------------------------------------------------------------------------------------------------------------------------------------------------------------------------------------------------------------------------------------------------------|
| | | |
| <p>High-speed, high-quality images</p> <p>Equipped with an OMRON in-house camera optimized for inspection. High-definition images with low noise and strong contrast acquired and inspected at high speed. The inspection speed is about 150%*⁸ faster than the conventional one.</p> <p>*7: Compared to our VT-S10 series-based verification substrates. *8: CoaXPress 2.0. An interface standard that enables high-speed transmission of large amounts of data.</p> | <p>Phase shift+ MPS</p> <p>Equipped with a proprietary design projector. Automatic control of multiple fringe patterns and light intensity realizes optimal inspection. The effect of secondary reflective is also minimized by use of MPS technology.</p> <p>*9: Micro Phase Shift</p> | <p>Direction lighting + White lighting</p> <p>Equipped with a technique to Irradiate multidirectional RGB lights. More high-precision inspection accomplished by capturing variety of shape information even complex fillet shapes. Applied white lighting allows accurate detection and reading of component printing.</p> <p>*10: Multi Direction Multi Color</p> <p>Direction lighting</p> <p>lighting pattern (A) (B) Acquired data (A) (B) Result</p> <p>Capture the shape of solder more accurately</p> |
| + | | |
| <p>Higher accuracy with AI model generated from huge number of images.</p> | | |

Noise reduction

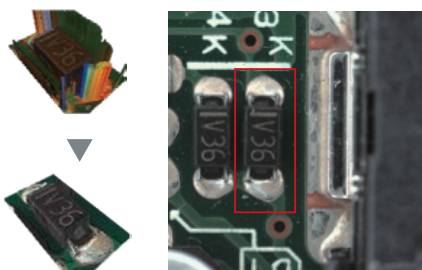

Reduces the effect of shadows due to large parts

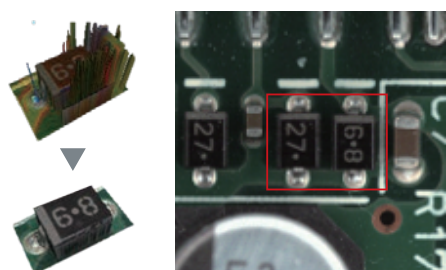

Deeper angled image of rear end connector

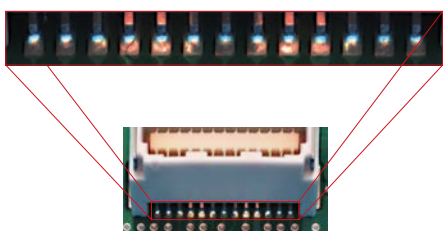

Stable inspection of microscopic parts

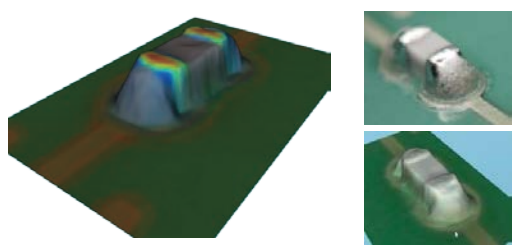

For sample image details Please check here.

Minimization of programming efforts by quantitative inspection and AI-assisted qualitative inspection



Quantative inspection is compliant with international standards*11

Directly set machine inspection criteria is based on international standards applied as inspection criteria, it doesn't rely on the skill and expertise of the programmer.

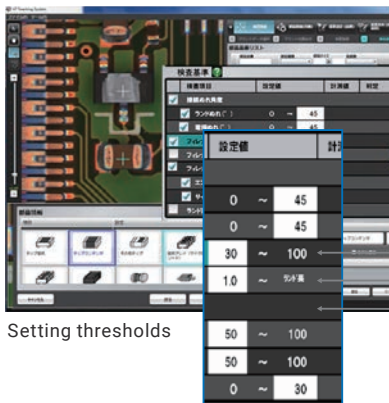

Setting thresholds

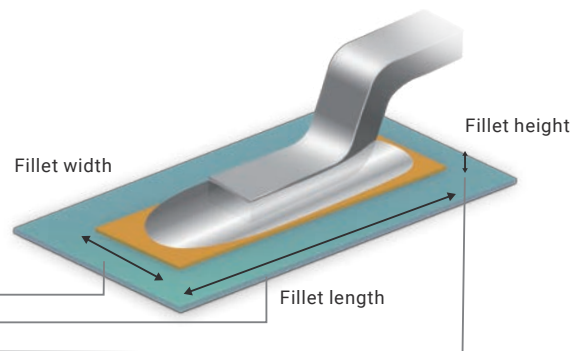

*11.IATF (ISO/TS) 16949, IPC quality standards, etc.

AI inspection logic that reduces man-hours dependent inspection

Omron has been developing a variety of reliable AI tools to address customer concerns such as defects going undetected and/or managing large amounts of machine learning data when using AI for inspection. AI judgement makes inspection more less skilled dependent and it contributes to the improvement of production by enhancement of detection and reduction of false calls or visual checks.

"OK image" base

AI model is based on inspection images judged as good from the machine learned database. The difference between the AI model and the inspection target is quantified to determine the good or no good product.

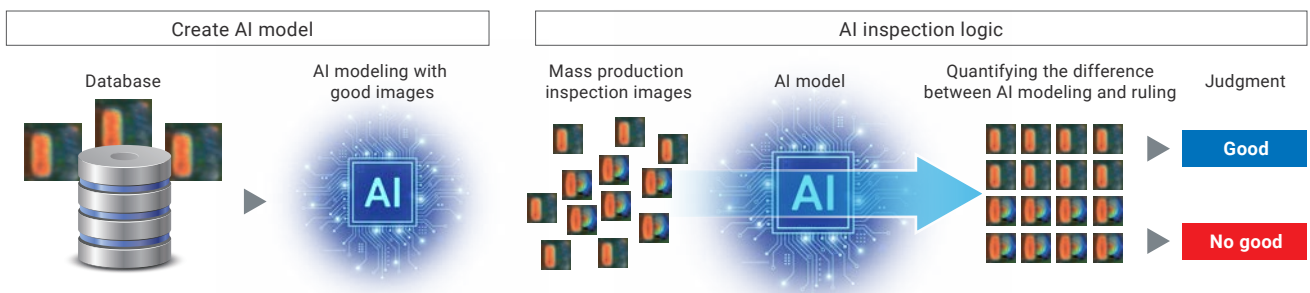

AI learning tool

Learning tools enable skill-less annotation, inspection criteria setting, and pre-mass production verification of AI logic.

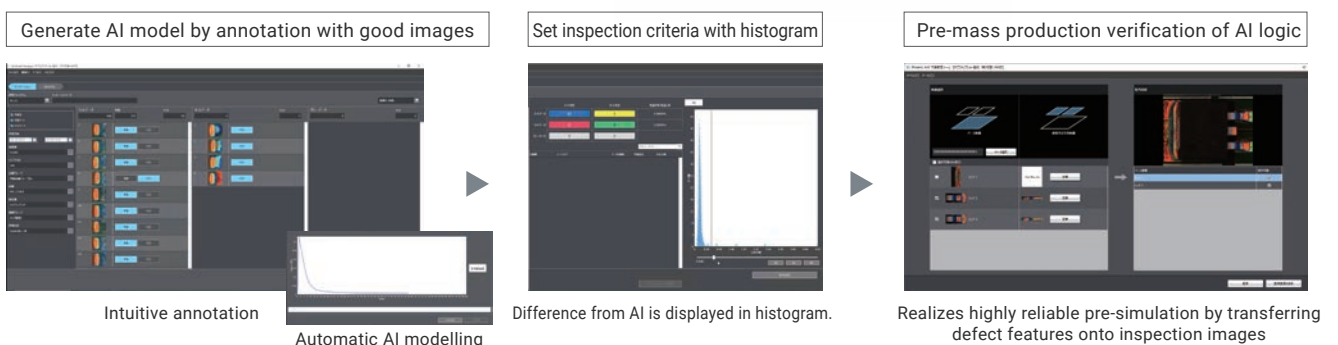

Maximizing good-quality throughput by using quality focused, M2M communication



M2M system

To optimize the quality and equipment operation status without human intervention, made possible by enabling autonomous communication and exchange of information between various connected, production equipment.

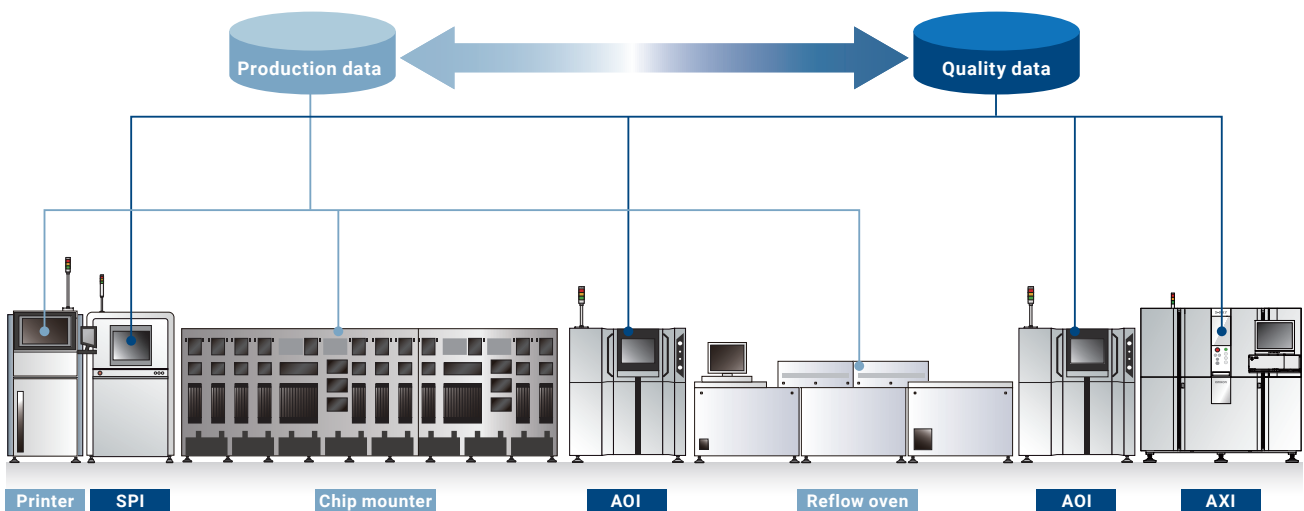

Prevention of defects

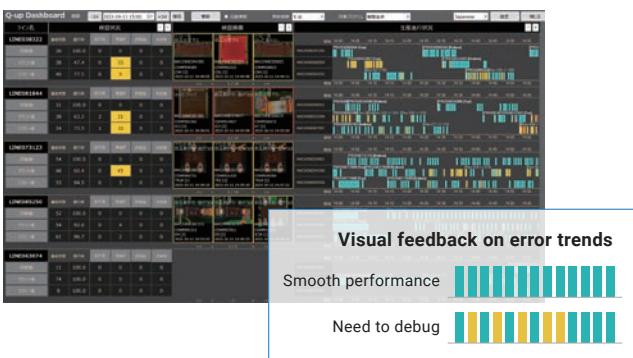

Early identification of factors of defects

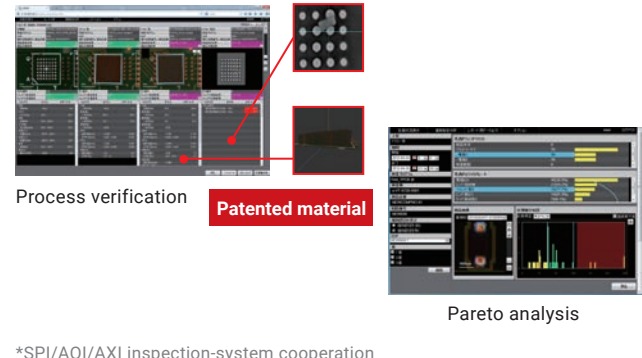

Preventing defects

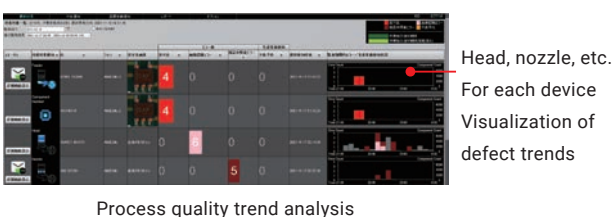

Improvement of Line Orthogonal Rate

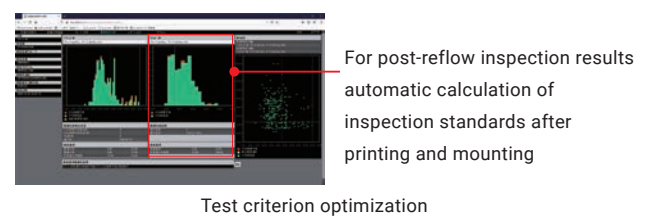

*MtoM Systems (Q-upAuto) in the coordinated mounter equipments A license is required.

*CKD licenses to optimize the test criteria for print inspections

Zero down time production line with equipment monitoring and predictive maintenance

Equipped with Omron control hardware technology, this system allows real-time collection of information from all the IoT connected devices inside the inspection equipment. It allows the equipment status to be visualized, enabling predictive maintenance and quality traceability.



System configuration

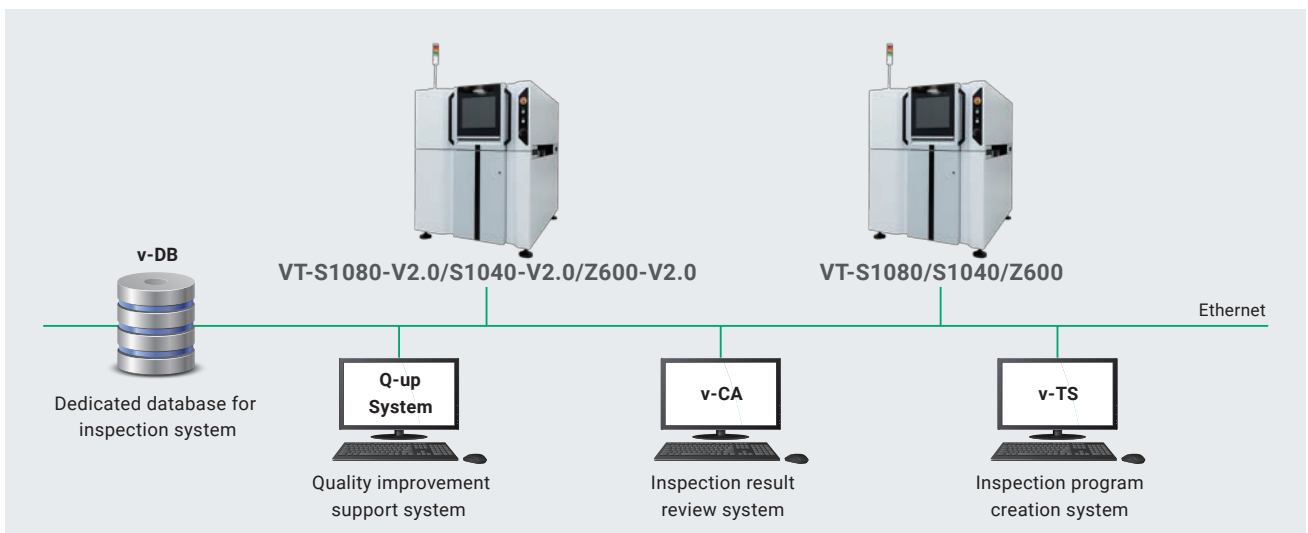

VT series product line-up

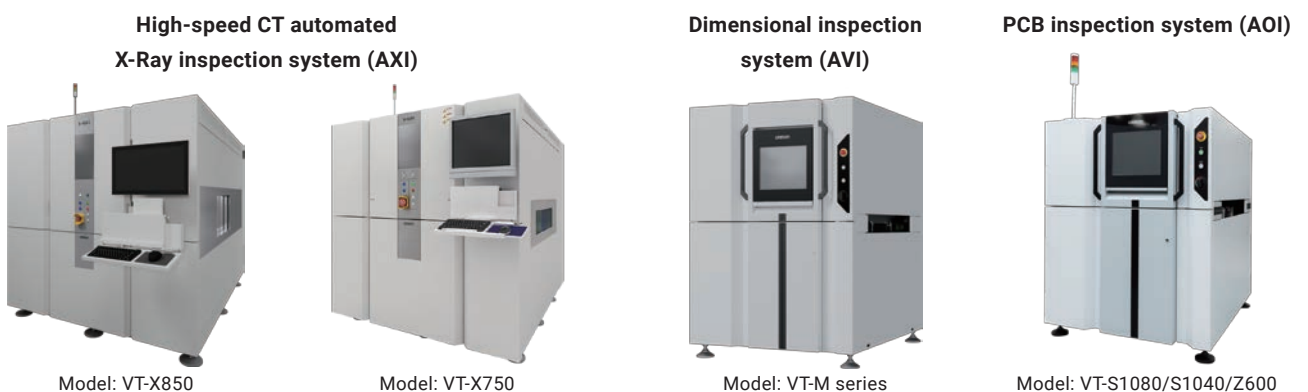

Outline dimensional drawing

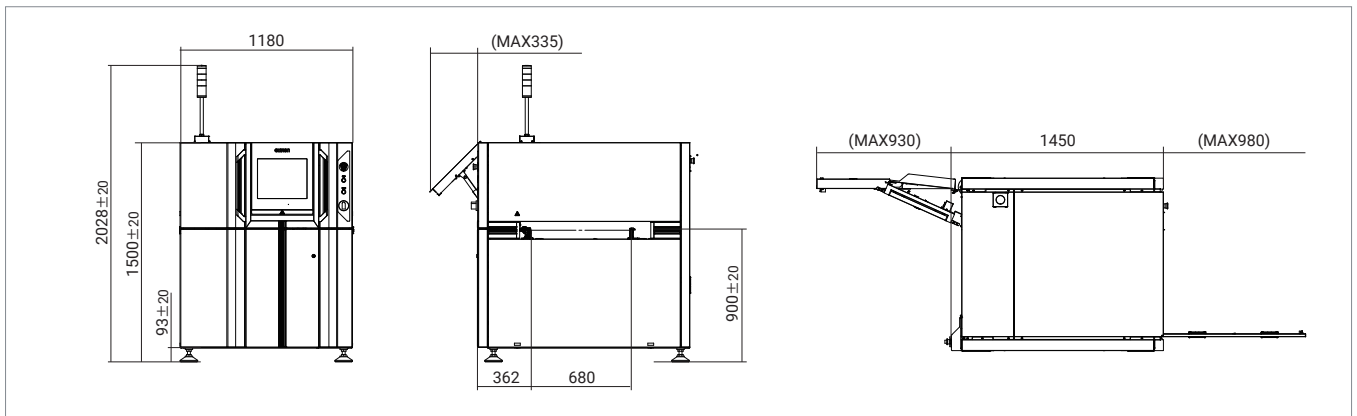

Hardware configuration / Functional specifications

| Type | VT-S1080-V2.0 | VT-S1040-V2.0 | VT-Z600-V2.0 |
|-----------------------------|--------------------------------------------------------------------------------------------------------------------------------------------------------------------------------------------------------------------------------------------------------------------------------------------------------------------------------------------------------------------------------------------------|---------------------------------------------------------------------------------------------------------------------------------------------------------------------------------------------------------------------------------------------------------------------------------------------------------------------------------------------------------------------|-------------------|
| Outer dimensions | 1180(W) x 1450(D) x 1500(H)mm | | |
| Weight | Approx. 1240Kg | | |
| Power supply | 200 to 240 V AC (Single phase); Voltage fluctuation range $\pm 10\%$ 50/60Hz | | |
| Rated power | 2.0 kVA (Maximum current 10 A) | | |
| Line height | 900 \pm 20mm | | |
| Air supply | Not required | | |
| Operating temperature range | 10 \sim 35°C | | |
| Operating humidity range | 35 to 80% RH (Non-condensing) | | |
| Camera | Top | 12Mpix | |
| | Angle | 5Mpix | — |
| Resolution | Top | 12.5 μ m | |
| | Angle | 10 μ m | — |
| FOV | Top | 52.5 x 52.5mm | |
| | Angle | 25.9 x 19.4mm | — |
| Inspection principle | MDMC*12 illumination+3D reconstruction through MPS*13 | MDMC*12 illumination+3D reconstruction through MPS*13*14 | MDMC illumination |
| Supported PCB size | Size | Single lane: 50(W) x 50(D) \sim 510(W) x 680(D)mm Dual lane: 50(W) x 50(D) \sim 510(W) x 330(D)mm | |
| | Thickness | 0.4 \sim 4mm | |
| | Weight | 4 Kg | |
| Clearance | Above the conveyor belt: 54 mm or less; Below the conveyor belt: 50 mm or less (Including board thickness/curvature/bend/part tolerance, etc.) | | |
| Height measurement range | 25.4mm | | — |
| Inspection item | Component height, lift, tilt, missing or wrong component, wrong polarity, flipped component, OCR inspection, 2D code, component offset (X/Y/rotation), fillet (height/length, end joint width, wetting angle, side joint length), exposed land, foreign material, land error, lead offset, lead posture, lead presence, solder ball, solder bridge, distance between components, component angle | Missing or wrong component, wrong polarity, flipped component, OCR inspection, 2Dcode, component offset (X/Y/rotation), fillet (height/length, end joint width, wetting angle, side joint length)*9, exposed land, foreign material, land error, lead offset, lead posture, lead presence, solder ball, solder bridge, distance between components, component angle | |

*12. MDMC : Multi Direction/Multi Color *13. MPS : Micro Phase Shift *14. Option

- The application examples described in this brochure are for reference only. Please check the functions and safety of the equipment before using it
- When using in conditions or environments not described in this brochure, or for applications such as nuclear energy control systems, railroad systems, aviation systems, vehicles, combustion systems, medical equipment, amusement machines, safety equipment and others that could present a risk to life or property, Omron assumes no guarantee regarding the products except in the case of special product uses identified by Omron or with special agreement.
- When exporting (or providing to non-residents) this product, its parts or technology falling under the categories of export permissions or approved cargo (or technology) stipulated in the Foreign Exchange and Foreign Control Trade Law, an export permission and approval (or permission for service transaction) shall be necessary based on the same law.

OMRON Corporation

INDUSTRIAL AUTOMATION COMPANY INSPECTION SYSTEMS BUSINESS DIVISION SALES DEPARTMENT

Shinagawa Front Bldg. Conference 7F
2-3-13 Kounan Minato-ku Tokyo
108-0075 JAPAN
TEL +81-3-6718-3550 FAX:+81-3-6718-3553

OMRON INDUSTRIAL AUTOMATION (CHINA) CO., LTD.

F20, Tower A, NEO Building, 6011 Shennan Avenue,
Futian District, Shenzhen, Guangdong 518048, China
TEL:+86-755-8359-9028 FAX:+86-755-8359-9628

Omron AOI Business Europe, Omron Europe B.V.

Zilverenberg 2, 5234 GM 's-Hertogenbosch,
The Netherlands
TEL:+31 (0)736 481811 FAX:+31(0)736 481879

OMRON TAIWAN ELECTRONICS INC.

9F-1, No.8, Ziqiang S. RD., Zhubei City, Hsinchu
County 302, Taiwan R.O.C.
TEL: +886-3-667-5557 FAX: +886-3-667-5558

OMRON ELECTRONICS KOREA CO.,LTD.

21F, Kyobo Tower B Wing, 465, Gangnam-daero,
Seocho-gu, Seoul, Korea 137-920
TEL:+82-2-3483-7789 FAX:+82-2-3483-7788

OMRON ASIA PACIFIC PTE LTD

438A Alexandra Road #05-05/08 (Lobby 2)
Alexandra Technopark Singapore 119967
TEL:+65-6835-3011 FAX:+65-6835-2711

Omron Automation Pvt. Ltd.

The Qube, 5th Floor, Unit No. 501-504 MV Road,
Marol, Andheri (East), Mumbai – 400 059, India
Fax: (91-22) 7115 5602

OMRON ELECTRONICS LLC

2895 Greenspoint Parkway, Suite 200,
Hoffman Estates, IL 60169, U.S.A
TEL:(1) 847-843-7900 FAX:(1) 847-843-7787

Authorized Distributor: